



GM X-BODY RESTORATION PARTS



INDEX

Description	Page	Description	Page	Description	Page
Acceleration Pedal	238	Fender Emblems	268	Radio Knobs	233
Air Cleaner	217	Fender, Front	211	Rear Body Emblem	269
Alternator & Ignition	216	Fender, inner	211	Rocker Panel	228
Antenna	220	Firewall	220	Roof	244
Apparell	269	Floor	245	Seat	243
Arm Rest	227	Frame Connector	263	Sending Unit	251
Ashtray	234	Frame Rail	266	Shift Boot	238
Back Glass	252	Gas Tank	251	Shift Boot	238
Back-Up Lamp	261	Gas Tank Straps	251	Side Marker	270
Battery	214	Gauge	231	Spare Tire	249
Body Bumper	261	Glove Box	234	Speedometer	230
Brake/Clutch Pedal	241	Grille	209	Steering Wheel	235
Bumper Filler	205	Grille Emblems	268	Steering/Suspension	262
Bumper, Front	205	Hardware	244	Subframe	265
Bumper, Rear	206	Headlamp	207	Sun Visor	229
Clock	230	Headlight	267	Switch	233
Clutch Linkage	242	Heater/Air	232	Tachometer	230
Console	238	Hood	212	Tail Panel	249
Console Shifter	238	Hood Accessories	213	Taillight	260
Control Arm	262	Hood Hinge	213	Timing Chain Cover	215
Cowl	221	Insulation	218	Transmission Crossmember	263
Crankshaft Pulley	217	Knobs & Bezels	233	Trunk	248
Dash	229	Leaf Spring	266	Trunk Emblem	269
Dash Emblem	269	License Plate	206	Trunk Floor	248
Deck Lid	247	Lighter	234	Turn Signal Lever	239
Dome Lamp	229	Mirror	225	Underhood Detail	219
Door Decal	268	Molding/Trim	267	Valve Cover	214
Door Glass	254	Package Tray	247	Vent Glass	255
Door Handle	224	Paint Gasket	261	Weatherstrip	261
Door Hinges	223	Park Lamp	269	Wheel Bearing	263
Door Latch	223	Parking Brake	243	Wheelhouse	247
Door Skins	222	Pedal Pad	240	Window Crank Handle	227
Door Weatherstrip	225	Power Steering	216	Window Felts	255
Engine Frame Mount	215	Quarter Glass	254	Window Regulator	255
Engine Lift Bracket	215	Quarter Panel	246	Windshield	252
Engine Oil Dipstick	218	Quarter Panel Emblem	269	Windshield Washer Jar	218
Fan Shroud	210	Radiator	210	Wiper Switch	233



FRONT BUMPERS



1



2



3



4



5



6



7



8



9



11



10

#	YEAR	DESCRIPTION	GM	MODEL	PART #
1	62-64	Front Bumper		Chevy II Nova	100-3062
2	65	Front Bumper		Chevy II Nova	100-3065
3	66-67	Front Bumper		Chevy II Nova	100-3066
4	68-69	Front Bumper		Chevy II Nova	100-3068
5	70-72	Front Bumper		Nova	100-3070
6	66-67	Front Bumper Brackets - Inner - Pair		Chevy II Nova	K-N6533
7	68-72	Front Bumper Brackets - Inner and Outer - LH		Chevy II Nova	K-N68722
	68-72	Front Bumper Brackets - Inner and Outer - RH		Chevy II Nova	K-N68721
8	62-65	Front Bumper Bolt Set - 32 pcs		Chevy II Nova	101-3062-S
9	66	Front Bumper Bolt Set - 24 pcs		Chevy II Nova	101-3066-S
10	67	Front Bumper Bolt Set - 24 pcs		Chevy II Nova	101-3067-S
11	68-72	Front Bumper Bolt Set - 32 pcs		Chevy II Nova	101-3068-S

BUMPER FILLER



1



2



3



4

VISIT US ONLINE FOR THE MOST UP-TO-DATE PRICING AND SELECTION



#	YEAR	DESCRIPTION	GM	MODEL	PART #
1	62-65	Grille to Bumper Filler		Chevy II Nova	X115-3062
2	66-67	Grille to Bumper Filler		Chevy II Nova	X115-3066
3	68-72	Grille to Bumper Filler - Metal		Chevy II Nova	115-3068-1
4	68-72	Grille to Bumper Filler - Plastic		Chevy II Nova	115-3068-2

REAR BUMPERS



1



2



3



4



5



6



7



8

#	YEAR	DESCRIPTION	GM	MODEL	PART #
1	62-65	Rear Bumper		Chevy II Nova	990-3062
2	66-67	Rear Bumper		Chevy II Nova	990-3066
3	68-72	Rear Bumper		Chevy II Nova, Ventura	990-3068
4	68-72	Rear Bumper Bracket - LH		Chevy II Nova	X970-3068-L
	68-72	Rear Bumper Bracket - RH		Chevy II Nova	X970-3068-R
5	62-65	Rear Bumper Bolt Set - 30pcs		Chevy II Nova	991-3062-S
6	66	Rear Bumper Bolt Set - 32pcs		Chevy II Nova	991-3066-S
7	67	Rear Bumper Bolt Set - 32pcs		Chevy II Nova	991-3067-S
8	68-72	Rear Bumper Bolt Set - 32pcs		Chevy II Nova, Ventura	991-3068-S

LICENSE PLATE



1



2



3



5



6



7



4

VISIT US ONLINE FOR THE MOST UP-TO-DATE PRICING AND SELECTION



#	YEAR	DESCRIPTION	GM	MODEL	PART #
1	66-72	License Lamp Assembly		Chevy II Nova, Ventura	W-773
2	68-72	License Plate Bracket - Rear - w/ Hinge		Chevy II Nova, Ventura	W-309
3	73-74	License Plate Bracket - Rear		Nova	945-3570
4	66-72	License Plate Light Lens		Chevy II Nova, Ventura	W-338
5	62-65	License Plate Bumpers - Rear - 4pcs		Chevy II Nova	K-K132
6	66-73	License Plate Bumpers - 3pcs		Chevy II Nova	W-536
7	67-88	License Plate Hardware Set - 8pcs		All X-Body	X102-3067-4S
7	69	License Plate Hardware Set - 4pcs		All X-Body	X102-3067-S

HEADLAMP



#	YEAR	DESCRIPTION	GM	MODEL	PART #
	62-64	Headlamp Bezel - LH		Chevy II Nova	X145-3062-L
	62-64	Headlamp Bezel - RH		Chevy II Nova	X145-3062-R
	65	Headlamp Bezel - LH or RH		Chevy II Nova	X145-3065
1	66	Headlamp Bezel - LH or RH		Chevy II Nova	T3055
2	67	Headlamp Bezel - LH		Chevy II Nova	K-38922B1
	67	Headlamp Bezel - RH		Chevy II Nova	K-38922B2
3	68	Headlamp Bezels - Black - Pair		Chevy II Nova	X145-3068-1P
4	68	Headlamp Bezels - Chrome-Black - Pair		Chevy II Nova	X145-3068-P
5	69-72	Headlamp Bezels - Pair		Nova	K-C1671A
	73-74	Headlamp Bezel - LH		Nova	X145-3073-L
	73-74	Headlamp Bezel - RH		Nova	X145-3073-R
6	67	Headlamp Bezel Seals - Pair		Chevy II Nova	K-K420



VISIT US ONLINE FOR THE MOST UP-TO-DATE PRICING AND SELECTION



Officially Licensed GM Parts



WARNING: Cancer and Reproductive Harm - www.P65Warnings.ca.gov

WWW.AUTOMETALDIRECT.COM

833.404.4445

207

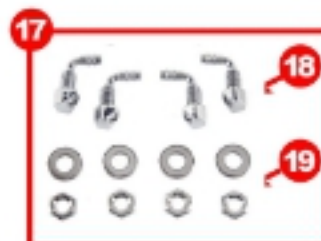

#	YEAR	DESCRIPTION	GM	MODEL	PART #
1	62-72	Headlamp Retainer Ring - 1" Width w/ Oval Hole	☑	Chevy II Nova	146-3062
2	73-79	Headlamp Retainer Ring - Round - 1" Width w/ Notch		Nova, Ventura	W-770A
	75-79	Headlamp Retainer Ring		Chevy II Nova	X146-4073
3	62-72	Headlamp Retainer Ring Screw Set - 6pcs		Chevy II Nova	H-117
	62-66	Headlamp Mounting Ring		Chevy II Nova	X141-3062
	67-74	Headlamp Mounting Ring - LH		Chevy II Nova	W-699
4	67-74	Headlamp Mounting Ring - RH		Chevy II Nova	W-698
	75-79	Headlamp Mounting Ring - Round		Chevy II Nova	X141-4073
5	62-63	Headlamp Switch		Chevy II	X460-4060-11
6	64-73	Headlamp Switch		Chevy II Nova	X460-4064-11
7	74-79	Headlamp Switch		Nova	X460-5568-11
8	62-63	Headlamp Switch Rod and Knob - Chrome		Nova	X460-3062-12
9	65-66	Headlamp Switch Rod and Knob		Nova	X460-3065-12
10	67	Headlamp Switch Rod and Knob		Nova	W-268
11	72-76	Headlamp Switch Rod and Knob		Nova, Ventura	K-3986886
12	69-70	Headlamp Switch Shaft & Knob		Nova	W-353
13	68	Headlamp Switch Nut		Nova	K-3916710
14	69-79	Headlamp Switch Nut		Nova	K-3919021
15	62-74	Headlamp Spring - 2 Required		Nova	W-785
16	68-79	Headlamp Washer Nozzle Screws - Pair		Chevy II Nova	H-156
17	69	Headlamp Washer Nozzle Set - 12pcs		Nova	W-158
18	69	Headlamp Washer Nozzle Nut and Washer Set - 8pcs		Nova	W-158A
19	69	Headlamp Washer Nozzle Set - 4pcs		Nova	W-158B
20	62-67	Headlamp Adjuster Set - 10 pcs		Chevy II Nova	W-785A



VISIT US ONLINE FOR THE MOST UP-TO-DATE PRICING AND SELECTION



GRILLE

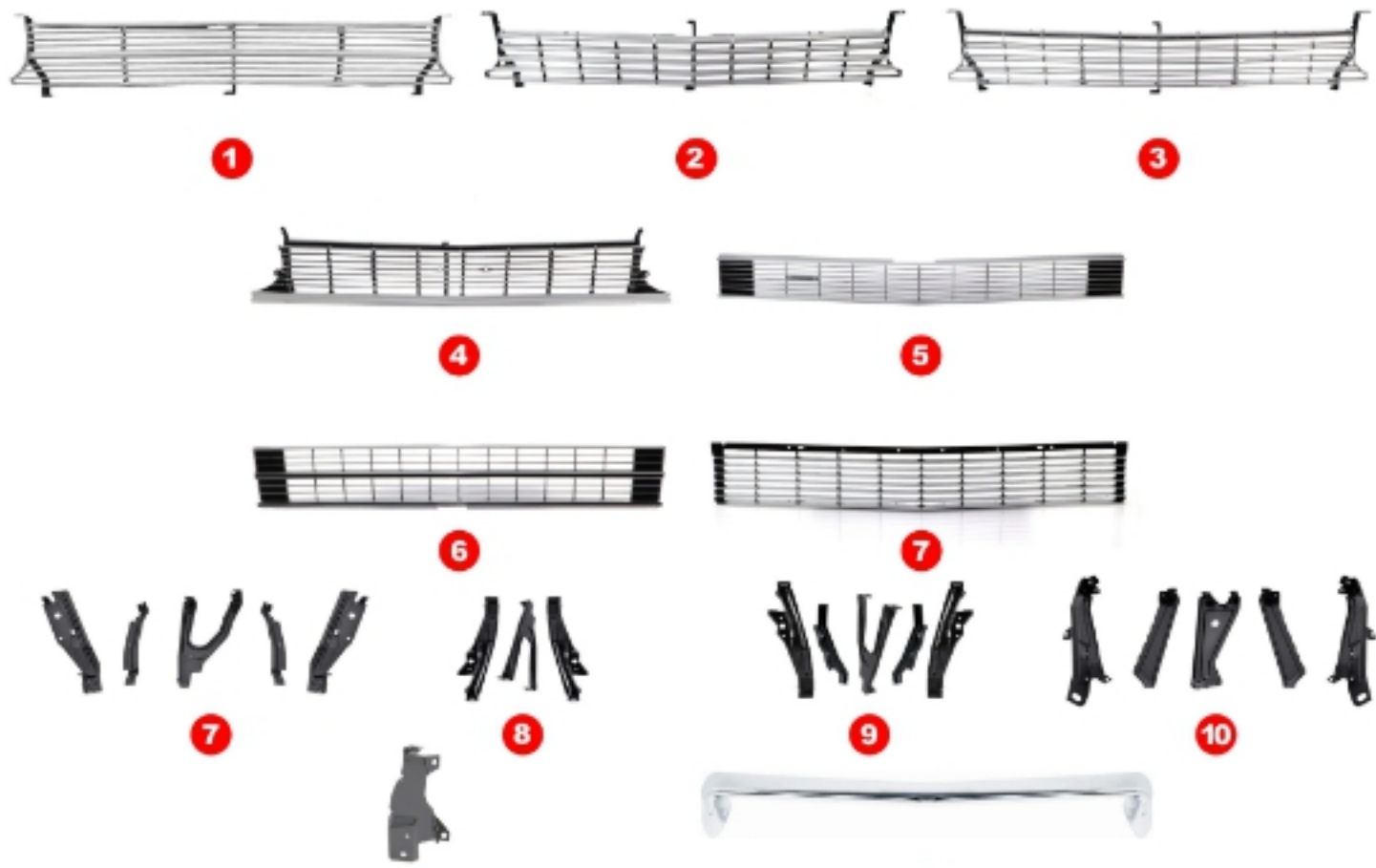

#	YEAR	DESCRIPTION	GM MODEL	PART #
1	62	Grille	Chevy II Nova	K-3792544
2	63	Grille - Argent	Chevy II Nova	X150-3063
3	64	Grille - Argent	Chevy II Nova	X150-3064
4	65	Grille - Argent	Chevy II Nova	X150-3065
5	66	Grille - Argent	Chevy II Nova	X150-3066
6	67	Grille - Argent	Chevy II Nova	X150-3067
7	68-69	Grille - Argent - except SS	Chevy II Nova	X150-3068
	68-69	Grille - Black	Chevy II Nova SS	X150-3068-SS
	70-72	Grille - Argent - except SS or Rally Nova	Nova	X150-3070
	70-72	Grille - Black	Nova SS, Rally Nova	X150-3070-SS
	73-74	Grille - except SS - Silver	Nova	X150-3073
	73-74	Grille - Black	Nova SS	X150-3073-SS
7	62	Grille Bracket Set - 5pcs	Chevy II Nova	X152-3062-S
8	63	Grille Bracket Set - 3pcs	Chevy II Nova	X152-3063-S
9	64	Grille Bracket Set - 3pcs	Chevy II Nova	X152-3064-S
10	65	Grille Bracket Set - 5pcs	Chevy II Nova	X152-3065-S
	66	Grille Bracket Set - 6pcs	Chevy II Nova	X152-3066-S
11	68-72	Grille Support Bracket - LH	(15) Chevy II Nova	152-3068-L
	68-72	Grille Support Bracket - RH	(15) Chevy II Nova	152-3068-R
	73-74	Grille Support Bracket - LH	(15) Chevy II Nova	X152-3073-L
	73-74	Grille Support Bracket - RH	(15) Chevy II Nova	X152-3073-R
12	62-65	Grille Guard - Chrome	Chevy II Nova	K-985435



VISIT US ONLINE FOR THE MOST UP-TO-DATE PRICING AND SELECTION



RADIATOR SUPPORT



1



2



3



4



5



6



7



8



9



10



11



12



13

VISIT US ONLINE FOR THE MOST

 UP-TO-DATE PRICING AND SELECTION



#	YEAR	DESCRIPTION	GM	MODEL	PART #
1	62-64	Radiator Support		Chevy II Nova	X350-3062
2	65	Radiator Support		Chevy II Nova	X350-3065
3	66-67	Radiator Support		Chevy II Nova	X350-3066
4	68-74	Radiator Support - For SB & BB		Chevy II Nova	350-3068
5	68-70	Radiator Top Seal - Big Block		Chevy II Nova	J-40603
6	68-70	Radiator Retainer Pad - Big Block w/ 3.08" Cut Out		Chevy II Nova	K-6264100
6	68-79	Radiator Retainer Pad - Small Block		Chevy II Nova	K-371189
7	68-72	Radiator Support Bushing Set - OE Style - 4pcs		Chevy II Nova	SS-4B
8	68-72	Radiator Support Bushing Mount Set - w/ Hardware - 14pcs		Chevy II Nova	YV-015
9	69-72	Body & Radiator Support Bushings - 12pcs		Nova	K-K3026
9	73-74	Body & Radiator Support Bushings - 12pcs		Nova	K-K3034
10	65-72	Radiator Cap - RC-15		Chevy II Nova	YV-853
11	69-70	Fan Shroud Bracket - Upper - Big Block		Nova SS	K-3947621
12	68-74	Fan Shroud Mounting Clip - Lower - 2 Required		Chevy II Nova	K-K10100
13	68-72	Upper Radiator Support Tie Bar		Chevy II Nova	151-3068

FRONT FENDER



#	YEAR	DESCRIPTION	GM	MODEL	PART #
1	62-65	Front Fender - LH		Chevy II Nova	X200-3062-L
	62-65	Front Fender - RH		Chevy II Nova	X200-3062-R
2	67	Front Fender - LH		Chevy II Nova	X200-3067-L
	67	Front Fender - RH		Chevy II Nova	X200-3067-R
3	68-69	Front Fender - LH	PC	Chevy II Nova	200-3068-L
	68-69	Front Fender - RH	PC	Chevy II Nova	200-3068-R
4	70-74	Front Fender - LH	PC	Nova	200-3070-L
	70-74	Front Fender - RH	PC	Nova	200-3070-R
5	68-74	Front Fender Lower Rear Repair Panel - w/ Brace - LH		Chevy II Nova	205-3068-L
	68-74	Front Fender Lower Rear Repair Panel - w/ Brace - RH		Chevy II Nova	205-3068-R
6	68-74	Inner Fender - LH	PC	Chevy II Nova	250-3068-L
	68-74	Inner Fender - RH	PC	Chevy II Nova	250-3068-R
7	62-67	Inner Fender Front Patch - RH		Chevy II Nova	X250-3062-1R
8	67-92	Fender Bolts - 50pcs - 5/16-18 x 7/8 3/4 - Loose Washer OD 1/2		Nova	15783
9	62-67	Fender Skirt Rear Seals Set - w/ Hardware		Chevy II Nova	J-4059
10	68	Control Arm Dust Shield Set - w/ Hardware		Chevy II Nova	R-N106
	69	Control Arm Dust Shield Set - w/ Hardware		Nova	R-N107
	70-72	Control Arm Dust Shield Set - w/ Hardware		Nova	R-N108

VISIT US ONLINE FOR THE MOST UP-TO-DATE PRICING AND SELECTION





HOOD



1



2



3



4



5



6



VISIT US ONLINE FOR THE MOST UP-TO-DATE PRICING AND SELECTION



#	YEAR	DESCRIPTION	GM MODEL	PART #
1	62-65	Hood - 2" Raised Cowl	Chevy II Nova	300-3062-2
2	66-67	Hood - 2" Raised Cowl	Chevy II Nova	300-3066-2
3	68-72	Hood - OE Style - w/ SS Bracing	<input checked="" type="checkbox"/> Chevy II Nova	300-3068-1
4	68-72	Hood - 2" Raised Cowl	Chevy II Nova	300-3068-2
5	68-72	Hood - 4" Raised Cowl	Chevy II Nova	300-3068-4
6	73-74	Hood - 2" Raised Cowl	Nova	300-3073-2



HOOD ACCESSORIES



1



2



3



4



5



6



7



8



9



10



11



12



13



14

15



16



17



18

#	YEAR	DESCRIPTION	GM MODEL	PART #
1	63-65	Hood Hinge - OE Style - LH	Chevy II Nova	X310-3963-L
2	63-65	Hood Hinge - OE Style - RH	Chevy II Nova	X310-3963-R
3	66-67	Hood Hinges - Chrome - Pair	Chevy II Nova	W-936
4	66-67	Hood Hinges - OE Style - LH	Chevy II Nova	W-937
5	66-67	Hood Hinges - OE Style - RH	Chevy II Nova	W-955
6	66-67	Hood Hinges - Chrome - Pair	Chevy II Nova	W-955
7	68-79	Hood Hinges - Pair - w/ Springs	Chevy II Nova	W-996
8	68-79	Hood Hinge - LH - w/ Springs	Chevy II Nova	W-996L
9	68-79	Hood Hinge - RH - w/ Springs	Chevy II Nova	W-996R
10	63-64	Hood Hinge Spring - Heavy Duty 9 3/8"	Chevy II Nova	W-759
11	65-79	Hood Hinge Spring - 9"	Chevy II Nova	W-999
12	66	Hood Latch Assembly	Chevy II	X303-3066
13	73-74	Hood Latch Assembly	Nova	X303-3073
14	68-72	Hood Latch	☐ Chevy II Nova	303-3068
15	63-64	Hood Latch Support	Chevy II	X326-3063
16	66	Hood Latch Support	Chevy II Nova	X326-3066
17	68-72	Hood Latch Support	☐ Chevy II Nova	326-3068
18	67	Hood Latch Support Brace	Chevy II Nova	X326-3067
19	65-79	Hood Latch Safety Spring - Stainless	All X-Body	W-730
20	66-67	Hood Safety Latch Assembly - On Hood	Chevy II Nova	X303-3066-1S
21	62-65	Hood Side Bumpers - 4pcs	Chevy II Nova	J-4067
22	68-74	Hood Side Bumpers - 4pcs	Chevy II Nova	J-2179
23	68-75	Round Hood Bumpers - 2pcs	Chevy II Nova	W-532
24	68-72	Hood Scoop Inserts - Ribbed Style - Pair	Nova SS	X320-3567-P
25	68-72	Hood Insert Seals - Pair	Chevy II Nova	X320-3567-1P
26	68-72	Hood Louver Bezel - LH or RH	Chevy II Nova	K-3927442
27	62-67	Hood to Cowl Seal	Chevy II Nova	J-4058
28	68-74	Hood to Cowl Seal	Chevy II Nova	J-4055
29	64-68	Hood & Hinge Bolt Set - 8pcs	Chevy II Nova	H-G-4244

VISIT US ONLINE FOR THE MOST UP-TO-DATE PRICING AND SELECTION



BATTERY TRAY



#	YEAR	DESCRIPTION	GM	MODEL	PART #
1	62-67	Battery Tray		Chevy II Nova	X340-3062
2	68-74	Battery Tray		Chevy II Nova	340-3068
3	68-79	Battery Clamp		Chevy II Nova	341-3466
4	68-79	Battery Clamp Bolt		Chevy II Nova	341-3466-1
5	67	Battery Junction Block - w/ Correct Nut		Chevy II Nova	W-215
6	65-77	Positive Battery Cable Oil Pan Clip - 2 Required		Chevy II Nova	W-567

VALVE COVER



VISIT US ONLINE FOR THE MOST UP-TO-DATE PRICING AND SELECTION



#	YEAR	DESCRIPTION	GM	MODEL	PART #
1	67	Valve Covers - Chrome - Pair - 327/325hp L79 V8 (can fit all 59-67 small block V8)		Chevy II Nova	W-540
2	67	Valve Covers - Primer with "Chevrolet" Script - Pair		Chevy II Nova	W-541
3	68	Valve Covers - Chrome - 302, 327 L79 or 350 Chevy V8 - Pair		Chevy II Nova	W-542
4	68	Valve Covers - Primer - 307 or 327 V8 - Pair		Chevy II Nova	W-543
5	69-70	Valve Cover Elbow - Big Block		Nova	W-608
6	69-72	Valve Cover Elbow - Small Block		Nova	W-609



TIMING COVER



1



2



3



4

#	YEAR	DESCRIPTION	GM	MODEL	PART #
1	68	Timing Chain Cover - Big Block 396/427 w/ 8" Balancer		Chery II Nova	R-267
2	69-70	Timing Chain Cover - Small Block 302/350 4-bbl/400 2-bbl w/ 8" Balancer		Nova	R-260
3	69-70	Timing Chain Cover - Big Block 396/427/454 w/ 7" Balancer		Nova	R-265
4	69-70	Timing Chain Cover - Big Block 396/427/454 w/ 8" Balancer		Nova	R-268

ENGINE FRAME MOUNT



1

3



2



4

#	YEAR	DESCRIPTION	GM	MODEL	PART #
1	68-72	Engine Bracket Set - Big Block		Chery II Nova	W-62L
	68-72	Engine Frame Mounts - Small Block - Pair		Chery II Nova	W-992
	68-72	Engine Frame Mount - Small Block - LH		Chery II Nova	W-992L
2	68-72	Engine Frame Mount - Small Block - RH		Chery II Nova	W-992R
3	69-70	Engine Frame Mounts - Big Block - Pair		Nova	W-649
4	69-72	Engine Frame Mounts - 302/350		Nova	R-270

ENGINE LIFT



1



2

#	YEAR	DESCRIPTION	GM	MODEL	PART #
1	65-70	Engine Lift Bracket Set - Small Block V8		Chery II Nova	W-931
2	68-70	Engine Lift Bracket Set - Big Block		Chery II Nova	W-930



VISIT US ONLINE FOR THE MOST UP-TO-DATE PRICING AND SELECTION



Officially Licensed GM Parts



WARNING: Cancer and Reproductive Harm - www.P65Warnings.ca.gov

WWW.AUTOMETALDIRECT.COM

833.404.4445

215

ALTERNATOR & IGNITION



#	YEAR	DESCRIPTION	GM	MODEL	PART #
1	68	Alternator Mounting Bracket - Upper - Big Block		Chevy II Nova	W-888
2	68	Alternator Mounting Bracket - Lower - Cast Iron - Big Block		Chevy II Nova	W-436
3	69-70	Alternator Mounting Bracket Set - Upper & Lower - Big Block		Nova	W-417B
4	69-70	Alternator Mounting Brackets - Big Block - 3pcs		Nova	W-417
5	69-72	Alternator Mounting Brackets - Small Block - 9pcs		Nova	W-789
6	69-70	Alternator Mounting Brackets - Big Block - 9pcs		Nova	W-779
7	69-72	Alternator Mounting Bracket - Upper - Small Block		Nova	W-570
8	69-74	Alternator Mounting Bracket - Lower - Small Block		Nova	W-787
9	69-72	Alternator Mounting Bracket & Spacer - Rear - Small Block		Nova	W-747
10	69-70	Alternator Mounting Brace & Spacer - Rear - Big Block		Nova	W-786
11	69-70	Alternator Mounting Stud & Bolt - Big Block		Nova	W-417A
12	69-70	Alternator Mounting Bolts - Big Block - 5pcs		Nova	W-736
13	69-72	Alternator Mounting Bolts - Small Block - 4pcs		Nova	W-737
14	68-74	Ignition Coil Bracket - 25 Degree w/ Correct Bolt - 68-69 307-327-350-396 Chevy V8		Chevy II Nova	R-145

POWER STEERING



#	YEAR	DESCRIPTION	GM	MODEL	PART #
1	68	Power Steering Pump Bracket Set - Small Block 302 & 55-350		Chevy II Nova	W-095
2	68	Power Steering Pump Bracket Set - Big Block		Chevy II Nova	W-798
3	69	Power Steering Pump Bracket Set - Small Block		Nova	W-799
4	69	Power Steering Pump Bracket Set - Big Block		Nova	W-418
5	69	Power Steering Small Bracket - Big Block		Nova	W-418A
6	68	Power Steering Pump Adjuster Bracket - Small Block 302 & 55-350		Chevy II Nova	W-095B
7	68	Power Steering Pump Adjuster Bracket - Big Block		Chevy II Nova	W-689
8	69-72	Power Steering Pump Adjuster Bracket - Rear - Small Block		Nova	X397-3569
9	68	Power Steering Pump Cradle Bracket - Small Block 302 & 55-350		Chevy II Nova	W-095A
10	68	Power Steering Pump Cradle Bracket - Big Block		Chevy II Nova	W-688
11	69	Power Steering Pump Cradle Bracket - Small Block		Nova	W-799B
12	69	Power Steering Pump Rear Brace		Nova	W-799A
13	69-76	Power Steering Pump "S" Brace - Small Block		Nova	W-799C
14	64-68	Power Steering Driver Pulley - Small Block, Single Groove		Chevy II Nova	W-938
15	69-70	Power Steering Pulley - 396/375HP		Nova	W-395



VISIT US ONLINE FOR THE MOST UP-TO-DATE PRICING AND SELECTION



PULLEY



#	YEAR	DESCRIPTION	GM	MODEL	PART #
1	64-68	Crankshaft Pulley - Small Block Single Groove - w/o A/C		Chevy II Nova	YW-970
2	69-70	Crankshaft Pulley - 396/375HP Deep Double Groove		Nova	YW-396
3	69-72	Crankshaft Pulley - 396 325/350HP Double Groove		Nova	YW-396AD
4	69-75	Crankshaft Pulley - Big Block Triple Groove - w/ A/C		Nova	YW-037
5	69-78	Crankshaft Pulley - Small Block Triple Groove - w/ A/C		Nova	YW-036
6	69	Water Pump Pulley - 396/375HP Deep Single Groove		Nova	YW-394
7	66-68	Water Pump Pulley Reinforcement Plate		Chevy II Nova	YW-031

AIR CLEANER



#	YEAR	DESCRIPTION	GM	MODEL	PART #
1	68-70	Air Cleaner Assembly - Open Element - 396	92	Chevy II Nova	YW-813
2	68-70	Air Cleaner Base - Open Element - 396	92	Chevy II Nova	YW-814
3	66-69	Air Cleaner Lid - Black Open Element		Chevy II Nova	YW-244A
4	67-70	Air Cleaner Lid - Triple Chrome Open Element		Chevy II Nova	YW-244
5	66-70	Air Cleaner Element - 14" Open Element Style		Chevy II Nova	YW-260H
6	64-67	Air Cleaner Mesh Flame Arrestor	93	Chevy II Nova	YW-513
7	68-72	Throttle Rod - w/ Swivel - Universal Quadra-Jet 488L		Chevy II Nova	YW-636
8	68-69	Throttle Rod - w/ Swivel - Quadra-Jet 488L - 327 & 350		Chevy II Nova	YW-636B
9	68-72	Throttle Arm Lever		Chevy II Nova	YW-140A
10	66-73	Thermostat Housing - Aluminum w/ Stamped Part Number	99	Chevy II Nova	YW-544



VISIT US ONLINE FOR THE MOST UP-TO-DATE PRICING AND SELECTION



OIL DIPSTICK

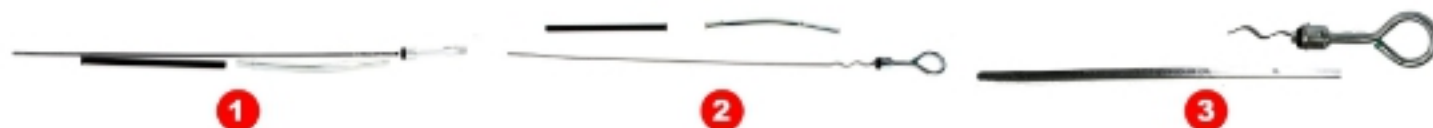

#	YEAR	DESCRIPTION	GM	MODEL	PART #
1	69-75	Engine Oil Dipstick & Tube Set - 1st Design - Small Block	Nova		R-680
2	69-75	Engine Oil Dipstick & Tube Set - 2nd Design - Small Block	Nova		R-681
3	69-75	Engine Oil Dipstick - 2nd Design - Small Block	Nova		R-655

WASHER JAR



#	YEAR	DESCRIPTION	GM	MODEL	PART #
1	68-70	Windshield Washer Jar & Bracket Set	Chevy II	Nova	K-K2535
2	64-70	Windshield Washer Jar	Chevy II	Nova	X343-3064-1
3	71-74	Windshield Washer Jar	Nova		X343-3471-1
4	75-79	Windshield Washer Jar	All X-Body		X343-3575-1
5	65-67	Windshield Washer Jar Bracket	Chevy II		X343-3065-1
6	68-70	Windshield Washer Jar Bracket	Nova		X343-3464-1



#	YEAR	DESCRIPTION	GM	MODEL	PART #
1	69	Plug Wire Tower - Upper LH - V8 (302 / 307 / 350)	Nova		W-791
2	66-70	Choke Coil Cover- 4BBL	Chevy II	Nova	W-830



#	YEAR	DESCRIPTION	GM	MODEL	PART #
1	64-79	Heat Shield Insulation and Sound Deadener - Single Sided 48x72	All X-Body		X403-1000-4872A
	64-79	Heat Shield Insulation and Sound Deadener - Double Sided 48x72	All X-Body		X403-1000-4872B



VISIT US ONLINE FOR THE MOST UP-TO-DATE PRICING AND SELECTION



STAY UP-TO-DATE WITH ALL THE LATEST



w/ KEVIN TETZ



SCAN HERE



KEVIN TETZ

#AMDGARAGE

UNDERHOOD HARDWARE

UH KITS

Typical kit does: accelerator lever & support, battery hold down clamp, brake booster, clutch push rod seal, control arm bushings, fender tie bar, fenders > firewall & radiator support, fuel vapor canister, grille & brackets & moldings, headlamp grounds, heater box, heater hose clips (included) at wheelhouse & alternator bracket, hood catch & lock plate, hood & hinges, hood levelers, horn & relay, master cylinder, radiator & fan shroud, radio ground straps, vacuum hoses, voltage regulator & ground wire, wiper motor (includes insulators), washer bottle & bracket, washer nozzles,

wheelhouses to fenders, wiring at blower motor, wiring gutter at firewall, wiring harness > rad support & wheelhouse.

Complete details at amdproducts.com/master-kits/chevrolet



Image is for reference only. Actual part(s) will vary depending on application.

#	YEAR	DESCRIPTION	GM	MODEL	PART #
64		Underhood Detailing Hardware Set - 167pcs	Chevy II	Nova	H-64N-UH
65		Underhood Detailing Hardware Set - 178pcs	Chevy II	Nova	H-65N-UH
66		Underhood Detailing Hardware Set - 166pcs	Chevy II	Nova	H-66N-UH
67		Underhood Detailing Hardware Set - 171pcs	Chevy II	Nova	H-67N-UH
68		Underhood Detailing Hardware Set - 154pcs	Chevy II	Nova	H-68N-UH
69		Underhood Detailing Hardware Set - 164pcs	Nova		H-69N-UH
70		Underhood Detailing Hardware Set - 150pcs	Nova		H-70N-UH
71		Underhood Detailing Hardware Set - 140pcs	Nova		H-71N-UH
72		Underhood Detailing Hardware Set - 145pcs	Nova		H-72N-UH

XU KITS

The fasteners (including clips & straps) to attach items common to every engine bay: battery hold down clamp, headlamp grounds, heater box, heater hose clips (included) at wheelhouse & alternator bracket, horn & relay, radiator & fan shroud, radio ground straps, vacuum hoses, voltage regulator & ground wire, wiper motor (includes insulators), washer bottle & bracket, washer nozzles, wiring at blower motor, wiring gutter at firewall, wiring harness > radiator support & wheelhouse.

#	YEAR	DESCRIPTION	GM	MODEL	PART #
64-66		Underhood Detailing Hardware Set - 58pcs	Chevy II	Nova	H-64N-XU
67		Underhood Detailing Hardware Set - 61pcs	Chevy II	Nova	H-67N-XU
68		Underhood Detailing Hardware Set - 65pcs	Chevy II	Nova	H-68N-XU
69-70		Underhood Detailing Hardware Set - 63pcs	Nova		H-69N-XU
71		Underhood Detailing Hardware Set - 48pcs	Nova		H-71N-XU
72		Underhood Detailing Hardware Set - 50pcs	Nova		H-72N-XU



VISIT US ONLINE FOR THE MOST UP-TO-DATE PRICING AND SELECTION



Officially Licensed GM Parts



WARNING: Cancer and Reproductive Harm - www.P65Warnings.ca.gov

WWW.AUTOMETALDIRECT.COM

833.404.4445



ANTENNA



3



4



5



6

1



2



7



#	YEAR	DESCRIPTION	GM	MODEL	PART #
	62-65	Antenna Template Set - Rear - LH		Chevy II Nova	W-1245
	62-65	Antenna Template Set - Front - RH		Chevy II Nova	W-1246
	62-65	Antenna Template Set - Rear - RH		Chevy II Nova	W-1247
	66-67	Antenna Template Set - Front - RH		Chevy II Nova	W-1248
	66-67	Antenna Template Set - Rear - RH		Chevy II Nova	W-1249
	68-72	Antenna Template Set - Front - RH		Chevy II Nova	W-1250
1	66-67	Antenna Mast - AM		Chevy II	K-986819
2	66-68	Antenna Body Assembly - Non-Threaded Push-on Type		Chevy II Nova	K-3880695
3	66-67	Antenna Gasket - Front		Chevy II Nova	J-4052
4	68-69	Antenna Bezel - Chrome		Chevy II Nova	K-3897333
5	65-68	Antenna Bezel Nut - Chrome - For Original Antenna Base		Chevy II Nova	K-3863499
	65-68	Antenna Bezel Nut - Chrome - For Reproduction Antenna Base		Chevy II Nova	K-3863499B
6	65-67	Antenna Bezel Gasket - 65-67 Rear, 68-69 Front		Chevy II Nova	K-3820672
7	70-79	Antenna Cable Lead		Chevy II Nova	K-K4424

FIREWALL



10

4

9

2



1



3



5



6

7



8



#	YEAR	DESCRIPTION	GM	MODEL	PART #
1	69-72	Firewall - w/o A/C - w/ Torque Boxes		Nova	370-3069
2	68-71	Firewall Wiring Gutter - w/ Hardware		Chevy II Nova	W-160
3	68-74	Firewall Pad Rubber Plugs - 4pcs		Chevy II Nova	W-272A
4	68-74	Firewall Heater Delete Plate Set - w/ A/C		Chevy II Nova	W-899
5	68-72	Firewall Carpet Guard Screws - 2pcs		Chevy II Nova	H-197
6	68-72	Firewall Accelerator Lever Support		Chevy II Nova	W-675
7	68-72	Firewall Accelerator Lever Support Screw Set		Nova	H-167
8	68-72	Firewall Accelerator Pedal Rod Through Firewall - VB		Chevy II Nova	W-676
9	70	Heater Box Tube Flange Plate - Big Block		Nova	W-631
10	70	Heater Box Cover - Big Block		Nova	W-961
11	70	Heater Box Seal Set - Big Block - 2pcs		Nova	W-963

VISIT US ONLINE FOR THE MOST UP-TO-DATE PRICING AND SELECTION



COWL



VISIT US ONLINE FOR THE MOST UP-TO-DATE PRICING AND SELECTION



#	YEAR	DESCRIPTION	GM	MODEL	PART #
1	66-67	Lower Cowl Panel		Chevy II Nova	X360-3066-1
2	68-72	Lower Cowl Panel - w/ A/C		Chevy II Nova	360-3068-1
3	68-74	Upper Inner Cowl Panel		Chevy II Nova	X360-3068
4	66-67	Upper Cowl Screen Panel		Chevy II Nova	X360-3066-2
5	68-74	Upper Cowl Screen Panel		Chevy II Nova	X360-3068-2
6	68-72	Cowl Side Outer Panel - LH	VB	Chevy II Nova	376-3567-L
	68-72	Cowl Side Outer Panel - RH	VB	Chevy II Nova	376-3567-R
7	68	Cowl & Firewall Seal Set		Chevy II Nova	J-3030
8	69-74	Cowl & Firewall Seal Set		Nova	J-3032



Officially Licensed GM Parts



WARNING: Cancer and Reproductive Harm - www.P65Warnings.ca.gov

WWW.AUTOMETALDIRECT.COM

833.404.4445

221



DOOR SKIN

Door Skin - 62-65 Chevy II Nova 2DR Hardtop & Convertible

LH = Driver Side, RH = Passenger Side

This reproduction door skin is designed specifically for 1962-1965 Chevy II Nova 2-door hardtop and convertible models. Stamped from high-quality steel, this door skin mirrors the original in shape, size, and detail, ensuring a precise fit for restoration projects. Each door skin includes the correct bends, curves, and pre-cut holes, making it easy to restore the original look and feel of your classic Nova. The panel arrives EDP coated, offering additional protection against rust and corrosion during the installation process.

Key Features:

- Fits 1962-1965 Chevy II Nova 2-door hardtop and convertible models.
- High-quality stamped steel construction for durability and accuracy.
- Features correct bends, curves, and pre-cut holes for easy installation.
- Arrives EDP coated for enhanced corrosion resistance.

1



-FRONT-



-SIDE-



-BACK-

Door Skin - LH - 68-72 Chevy II Nova 2DR

LH = Driver Side, RH = Passenger Side

Revive the classic appeal of your 1968-1972 Chevy II Nova 2DR with our premium replacement door skin. Designed for an exact fit, this high-quality door skin is built to factory specifications to restore the original look and performance of your vehicle.

Whether you're restoring a vintage Nova or completing a custom build, this door skin ensures a smooth, professional finish that matches the original factory design. Easy to install and engineered for longevity, it's the perfect solution for bringing your classic car back to life.

Key Features:

- Precision-engineered for 1968-1972 Chevy II Nova 2-door models
- Built to factory specifications for an authentic restoration
- Corrosion-resistant for lasting performance
- Easy to install with proper tools and instructions
- Factory-style fit for an original appearance

2



-FRONT-



-SIDE-

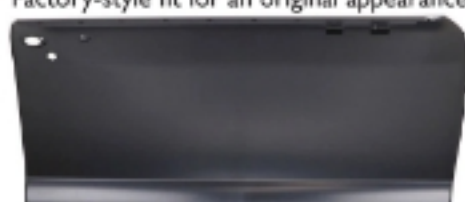

-BACK-

VISIT US ONLINE FOR THE MOST UP-TO-DATE PRICING AND SELECTION



#	YEAR	DESCRIPTION	GM	MODEL	PART #
1	62-65	Door Skin - 2DR Hardtop & Convertible - LH		Chevy II Nova	X510-3062-L
	62-65	Door Skin - 2DR Hardtop & Convertible - RH		Chevy II Nova	X510-3062-R
2	68-72	Door Skin - 2DR - LH		Chevy II Nova	510-3068-L
	68-72	Door Skin - 2DR - RH		Chevy II Nova	510-3068-R

DOOR HINGE



#	YEAR	DESCRIPTION	GM MODEL	PART #
1	62-66	Door Hinge - Upper - LH or RH	Chevy Nova	K-7580738
2	69-79	Door Hinge - Upper - LH	Chevy Nova	X520-3569-L
	69-79	Door Hinge - Upper - RH	Chevy Nova	X520-3569-R
3	62-67	Door Hinge - Lower - LH	Chevy Nova	K-4841357
	62-67	Door Hinge - Lower - RH	Chevy Nova	K-4841356
4	68-79	Door Hinge - Lower - LH	Chevy Nova	X525-3569-L
	68-79	Door Hinge - Lower - RH	Chevy Nova	X525-3569-R
5	68-74	Door Hinge Bolt Set - Upper & Lower - 30pcs	Chevy Nova	H-142
6	68-74	Door Hinge Rebuild Set	Chevy Nova	K-K106
7	63-67	Door Latch Assembly - LH - 63-65 4 DR - 63-67 2DR	Chevy Nova	X535-3066-L
	63-67	Door Latch Assembly - RH - 63-65 4 DR - 63-67 2DR	Chevy Nova	X535-3066-R
8	69-70	Door Latch Assembly - LH	Nova	X535-3569-L
	69-70	Door Latch Assembly - RH	Nova	X535-3569-R
9	66	Door Lock Control - LH	Chevy Nova	X535-3066-1L
	66	Door Lock Control - RH	Chevy Nova	X535-3066-1R
	67	Door Lock Control - LH	Chevy Nova	X535-3067-1L
	66	Door Lock Control - RH	Chevy Nova	X535-3067-1R
10	62-67	Door Bumpers - 4pcs	Chevy Nova	J-2320
11	68-74	Door Rubber Bumper - Upper - 2 Rqd per Door	Chevy Nova	K-20376243
12	68-74	Door Stoppers - Outer - 4pcs	Chevy Nova	K-K130
13	62-63	Door Alignment Wedge Set - Convertible	Nova	TS195



VISIT US ONLINE FOR THE MOST UP-TO-DATE PRICING AND SELECTION



Officially Licensed GM Parts



WARNING: Cancer and Reproductive Harm - www.P65Warnings.ca.gov

WWW.AUTOMETALDIRECT.COM

833.404.4445

DOOR HANDLE



1



2



3



5



6



7



8



9



10



11



12



13



14



15



16

#	YEAR	DESCRIPTION	GM	MODEL	PART #
1	62-65	Door Handle Assembly - Outside - Front - Pair		Chevy II Nova	T3013
	66-67	Door Handle Assembly - Outside - Rear - Pair		Chevy II Nova	T3063
	68-74	Door Handle Assembly - Outside - Pair		Chevy II Nova	T3081
2	68-74	Door Handle Set - Interior - Pair		Nova	X540-3568-P
3	65-67	Door Handle - Interior - LH or RH		All X-Body	W-618
5	62-64	Door Handle - Inside - Double Arm - LH or RH		Chevy II Nova	K-4753532
6	63-64	Door Handle - Inside - LH or RH		Chevy II	K-3764017
7	66-67	Door Handle - Outside - Front - 2/4DR - LH		Chevy II Nova	X530-3066-L
	66-67	Door Handle - Outside - Front - 2/4DR - RH		Chevy II Nova	X530-3066-R
8	62-74	Door Handle Push Button Set - 2 handles		Chevy II Nova	K-R5254
9	66-72	Door Handle & Lock Gasket Set - Does Both Doors		Chevy II Nova	J-3021
10	62-65	Door Handle & Lock Gasket Set - Does Both Doors		Chevy II Nova	J-41522
11	68-72	Door Opening Rod Retaining Clips - Pair		Chevy II Nova	W-070B
	68-72	Door Open Rod Retaining Clip - LH or RH		Chevy II Nova	W-070B-1
12	68-72	Door Rod Center Guide Clip - LH or RH		Chevy II Nova	W-070A
13	69-79	Door Jamb Vent Retaining Screws - Pair		All X-Body	H-130
14	62-65	Door Jamb Rubber U-Seals - Pair		Chevy II Nova	K-N180
15	66-67	Door Jamb Rubber U-Seals - Pair		Chevy II Nova	K-N179
16	62-72	Door Bottom Drain Hole Seal		Chevy II Nova	J-2118



VISIT US ONLINE FOR THE MOST UP-TO-DATE PRICING AND SELECTION



DOOR WEATHERSTRIP



#	YEAR	DESCRIPTION	GM	MODEL	PART #
1	62-67	Door Weatherstrips - 2-Door Coupe - Pair		Chevy II Nova	J-4002
	68-74	Door Weatherstrips - 2DR Sedan - Pair		Chevy II Nova	J-4020
2	62-63	Pillar Post Weatherstrips - Convertible - Pair		Chevy II Nova	J-4009

MIRROR

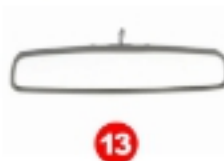

#	YEAR	DESCRIPTION	GM	MODEL	PART #
1	62	Door Mirror - Outside - w/ Hardware - "Bowtie" - LH or RH	☑	Chevy II	X570-3961
2	63-65	Door Mirror - Outside - Round w/ Smooth Base & Bowtie - LH or RH		Chevy II Nova	X570-3063-1
3	66-67	Door Mirror - Outside - Round w/ Ribbed Base & Bowtie - LH or RH	☑	Chevy II Nova	570-3567-B
5	67-72	Door Mirror - Outside - Round w/ Ribbed Base - LH or RH		Chevy II Nova	K-3909197
6	70-74	Door Mirror Mounting Set - Outside - Bullet Style - LH		Nova	K-R313
7	67	Rear View Mirror - Outside - w/o Bowtie - LH Remote		Chevy II Nova	X570-3067-2LA
8	68	Rear View Mirror - Outside - Remote - LH		Chevy II Nova	X570-3568-2LA
9	67	Rear View Bracket - Outside - LH Remote		Chevy II Nova	X570-3067-2LB
10	67	Rear View Gasket - Outside - LH Remote		Chevy II Nova	X570-3067-2LC
	64-66	Rear View Mirror - Inside - 8" Chrome w/o Day-Night		Chevy II	X645-3064-1
11	64-66	Rear View Mirror - Inside - 8" Stainless Day-Night		Chevy II	X645-3064-2
12	67-68	Rear View Mirror - Inside - 8" Stainless Day-Night		Chevy II	X645-3067-1
13	69-71	Rear View Mirror - Inside - 10" Stainless Day-Night		Nova	X645-3467-1
14	62-65	Rear View Mirror Bracket - Inside - Except Hardtop or Convertible		Chevy II	X645-3062-2
	62-65	Rear View Mirror Bracket - Inside - Hardtop		Chevy II	X645-3062-3
	62-63	Rear View Mirror Bracket - Inside - Convertible		Chevy II	X645-3062-4
15	62-72	Rear View Mirror Screw - Inside		All X-Body	X645-4060-5
16	69-72	Rear View Mirror Bushing - Inside		Nova	X645-4060-4

VISIT US ONLINE FOR THE MOST UP-TO-DATE PRICING AND SELECTION



Officially Licensed GM Parts



WARNING: Cancer and Reproductive Harm - www.P65Warnings.ca.gov

WWW.AUTOMETALDIRECT.COM

833.404.4445

225

INTERIOR - DOOR



1



2

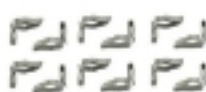

3



4



5



6



7



8



9



10



11



12



13

#	YEAR	DESCRIPTION	GM	MODEL	PART #
1	62-67	Door Sill Plates - Pair	12	Chevy II Nova	T-3000
2	68-74	Door Sill Plate - LH	12	Nova	K-7728957
	68-74	Door Sill Plate - RH	12	Nova	K-7728956
3	69-79	Door Panel Installation Clip Set - 12pcs	12	Chevy II Nova	H-119
4	69-79	Door Panel Clip Frame Plugs - 12pcs		Chevy II Nova	W-311
5	66	Door Lock Control - LH		Chevy II Nova	X535-3066-1L
	66	Door Lock Control - RH		Chevy II Nova	X535-3066-1R
6	67	Door Lock Control - LH		Chevy II Nova	X535-3067-1L
	67	Door Lock Control - RH		Chevy II Nova	X535-3067-1R
7	69-74	Door Lock Bellcrank Assembly - LH or RH		Nova	W-066
8	67-74	Door Lock Bellcrank Retainer - 2 Rqd Per Door		Chevy II Nova	W-067
9	68-79	Door Lock Striker		Chevy II Nova	W-774
10	68	Door Lock Rod - Inner - LH or RH		Chevy II Nova	W-069
11	62-79	Door Lock Set - w/ Round Keys		Chevy II Nova	X537-4067-1S
	68-72	Door Lock Knob Ferrules - Pair		Chevy II Nova	W-905
12	73-90	Door Lock Knob Ferrules		All X-Body	X536-3073-P
	68-70	Door Lock Knob - Die Cast Chrome Ribbed Shaft - Pair	12	Chevy II Nova	K-K546
13	71-79	Door Lock Knob - Chrome		All X-Body	536-4067-1CP
	62-66	Door Lock Knob - Taper Top - Black		All X-Body	536-4067-BP
	71-79	Door Lock Knob - Taper Top - Chrome		All X-Body	536-4067-CP



VISIT US ONLINE FOR THE MOST UP-TO-DATE PRICING AND SELECTION



WINDOW CRANK HANDLE



1



2



3



4



5



6



7



8



9



10



11



12



13

#	YEAR	DESCRIPTION	GM MODEL	PART #
1	62-64	Window Crank Handle - Chrome - Black Knob - Dual-Arm Style	Chevy II Nova	X546-3062-2
2	63-64	Window Crank Handle - Black Knob - 100 or 300 Models	Chevy II	X546-4053-1
3	65-79	Window Crank Handle - Clear Knob	Chevy II Nova	W-408
4	65-79	Window Crank Handle - Black Knob	Chevy II Nova	W-407
5	67	Window Crank Handle - Black Knob	All X-Body	W-595
6	67	Window Crank Handle - Clear Knob	All X-Body	W-595A
7	68-72	Window Crank Handle - Black Knob (paint to match)	Chevy II Nova	W-926
8	68-72	Window Crank Handle - Clear Knob	Chevy II Nova	W-926A
9	69-79	Window Crank Handle - Black Knob	Nova	X542-4067-B
10	73-76	Window Crank Handle - Clear Knob	All X-Body	W-927A
11	62-79	Window Crank Handle Plastic Washer	Chevy II Nova	K-20393850
12	62-79	Window Crank Handle Washer Set - 4pcs	Chevy II Nova	R-750
13	62-79	Window Crank Handle Spring	Chevy II Nova	K-4078002

ARM REST

1



2



3



4



5



VISIT US ONLINE FOR THE MOST UP-TO-DATE PRICING AND SELECTION



#	YEAR	DESCRIPTION	GM MODEL	PART #
1	68-72	Arm Rest Pad - Black Urethane - LH	Chevy II Nova	K-K695201
	68-72	Arm Rest Pad - Black Urethane - RH	Chevy II Nova	K-K695101
2	65-67	Arm Rest Base - Chrome - Pair	Chevy II Nova	W-518
3	68-72	Arm Rest Base - Black - LH	Chevy II Nova	W-076
	68-72	Arm Rest Base - Black - RH	Chevy II Nova	W-077
4	68	Arm Rest Base Stainless Steel Trim - Pair	Nova	W-034
5	68-72	Arm Rest Base Screws - 6pcs	Chevy II Nova	W-404



Officially Licensed GM Parts



WARNING: Cancer and Reproductive Harm - www.P65Warnings.ca.gov

WWW.AUTOMETALDIRECT.COM

833.404.4445

227

ROCKER PANEL



#	YEAR	DESCRIPTION	GM	MODEL	PART #
1	68-79	Rocker Panel - Inner - ZDR - LH		Chevy II Nova	440-3068-L
	68-79	Rocker Panel - Inner - ZDR - RH		Chevy II Nova	440-3068-R
2	68-74	Rocker Panel - Outer - ZDR - LH		Chevy II Nova	450-3068-L
	68-74	Rocker Panel - Outer - ZDR - RH		Chevy II Nova	450-3068-R
3	68-74	Door Hinge Pillar to Rocker Panel Support - LH		Chevy II Nova	440-3567-L
	68-74	Door Hinge Pillar to Rocker Panel Support - RH		Chevy II Nova	440-3567-R
4	66-67	Rocker Panel Moldings - w/ Hardware - Pair		Chevy II Nova	K-N6601
	62-74	Rocker Molding Clip - For 1 3/4" Moldings & 66-74 Upper Clip For 3" Moldings		Chevy II Nova	K-3886638
6	65-69	Rocker Panel Rear Drain Flaps - Pair		Chevy II Nova	W-538

DASH

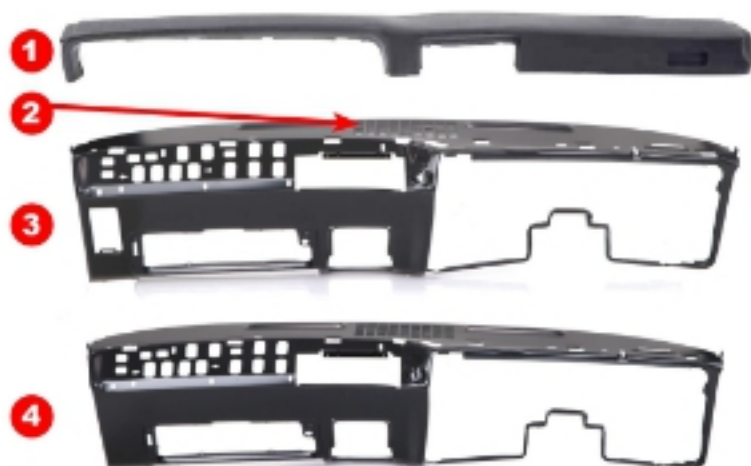

#	YEAR	DESCRIPTION	GM	MODEL	PART #
1	69-72	Dash Pad - OE-Style Vinyl Wrapped - w/ A/C		Nova, Ventura II	X464-3069-A
	69-72	Dash Pad - OE Style Vinyl Wrapped - w/o A/C		Nova, Ventura II	X464-4069
2	69-72	Dash Top - Upper Section		Nova	465-3569
3	69-72	Dash Panel - w/o A/C		Nova, Ventura II	X470-3069
4	69-72	Dash Panel - w/ A/C		Nova, Ventura II	X470-3069-A

DOME LAMP



#	YEAR	DESCRIPTION	GM	MODEL	PART #
1	62-70	Dome Lamp Assembly		Chevy II Nova	P-DLK001
2	71-74	Dome Lamp Assembly		Nova	P-DLK006
3	62-69	Dome Lamp Base		Chevy II Nova	W-117
4	71-79	Dome Lamp Base		Nova	R-731
5	71-79	Dome Lamp Lens		Nova	R-732
6	62-70	Dome Lamp Lens		Chevy II Nova	W-203

HEADLINER/SUNVISOR



#	YEAR	DESCRIPTION	GM	MODEL	PART #
1	67-71	Headliner Bow Clips - 4pcs		Chevy II Nova	W-600
2	69-73	Sun Visor Support - w/ Clamp Screw - Coupe Models Only		Chevy II Nova	W-339
3	74-78	Sun Visor Support		Nova	R-720
4	74-78	Sun Visor Support Mounting Screw Set - 6pcs		Nova	H-201
	69-73	Sun Visor Support Screw Set - Coupe Models Only		Chevy II Nova	W-606



VISIT US ONLINE FOR THE MOST UP-TO-DATE PRICING AND SELECTION



SPEEDOMETER



1



2



3



4



5



6



7



8



9



10



11



12



13



14



15



16

#	YEAR	DESCRIPTION	GM	MODEL	PART #
1	62-64	Speedometer - 120mph		Chevy II Nova	K-6406815
2	65	Speedometer - 120mph		Chevy II Nova	K-6455482
3	65-67	Speedometer		Chevy II Nova	K-6459272
4	69-74	Speedometer - w/o Console Gauges	12	Nova	K-6496615
5	71-74	Speedometer - w/ Console Gauges		Nova	K-6496617
6	62-69	Speedometer Cable - 55" Thread-On (w/o Grommet)		Chevy II Nova	K-6478125
	62-69	Speedometer Cable - 73" Thread-On (w/ Grommet)		Chevy II Nova	K-6478128
	69-74	Speedometer Cable - 69" Thread-On (w/ Grommet)		Nova	K-6478176
7	62-72	Speedometer Cable Firewall Grommet	18	Chevy II Nova	K-3792008
8	66-74	Speedometer Cable Clip - 4-Spd		Chevy II Nova	K-HC74
9	68-74	Tachometer - w/ Console Gauges	19	Chevy II Nova	K-5657301
	71-74	Tachometer - w/ Console Gauges		Nova, Ventura	K-5657301
10	63-65	Instrument Cluster Lens		Chevy II Nova	K-6406764
11	63-65	Instrument Cluster Bezel	12	Chevy II Nova	K-6406763
12	63-65	Clock		Chevy II Nova	K-3863796
13	71-76	Clock		Chevy II Nova	K-994125
14	71-76	Clock Opening Block-Off Plate		Nova	K-6496824
15	63-65	Clock Plug		Chevy II Nova	K-6406757
16	63-79	Clock or Tripmeter Reset Knob Stem Set		All X-Body	K-14053344



VISIT US ONLINE FOR THE MOST UP-TO-DATE PRICING AND SELECTION



GAUGES



8



9



10



16



17



18



19

#	YEAR	DESCRIPTION	GM MODEL	PART #
1	68-72	Gauge Assembly	Chevy II Nova	W-661
2	68-72	Gauge Base	Chevy II Nova	W-662
	68-74	Gauge Base - Green	Chevy II Nova, Ventura	W-170
3	68-74	Gauge Lens - 2 Rqd.	Chevy II Nova	W-188
4	68-72	Gauge Battery & Temp Bezel	Chevy II Nova	W-663
5	68-72	Gauge Fuel & Oil Bezel	Chevy II Nova	W-664
6	68-74	Oil Gauge Assembly - Black Face	12 Chevy II Nova	W-354A
7	68-74	Oil Pressure Gauge	12 Chevy II Nova	W-097
8	63-64	Fuel Gauge - w/ Warning Lights	Chevy II Nova	K-5644638
9	65	Fuel Gauge - w/ Warning Lights	Chevy II Nova	K-5644639
10	65-67	Fuel Gauge	Nova	K-6430436
11	68-74	Fuel Gauge	17 Chevy II Nova	W-098
12	70-74	Fuel Gauge Mounting Plate - Green - Front	Chevy II Nova	W-106A
13	68-74	Temp Gauge	12 Chevy II Nova	W-099
14	68-74	Amp Gauge	12 Chevy II Nova	W-100
15	70-74	Amp Temp Gauge Mounting Plate - Green - Rear	Nova	W-106B
16	68-74	Volt Gauge	Chevy II Nova	W-100A
17	63-64	Instrumental Gauge Cluster - 4 Gauge	Chevy II Nova	K-2196365
18	65	Instrumental Gauge Cluster - 4 Gauge	Chevy II Nova	K-2196565
19	68-69	Speed Warning Central Cable	Chevy II Nova	K-6454841



VISIT US ONLINE FOR THE MOST UP-TO-DATE PRICING AND SELECTION



HEATING & AIR



1



2



3



4



5



6



8



9



10



11



12



13



14

#	YEAR	DESCRIPTION	GM	MODEL	PART #
1	69-72	Air Vent Bezel - RH		Nova	K-14942
2	69-72	Air Vent Assembly Center - w/ A/C		Nova	K-3937166
3	69-72	Air Vent Assembly - Dash Side - LH or RH		Nova	WV-274
4	65-67	Air Flow Control Cable		Chevy II Nova	K-8756278
5	68	Defroster Vent Assembly		Chevy II Nova	K-3925711
6	69-79	Defroster Vent Duct Assembly		All X-Body	K-3973729
7	71-74	Heater Control Assembly - White Font - w/o A/C		Nova	K-356199C
	69-70	Heater Control Assembly - Green Font - w/ A/C		Nova	K-6273372C
8	69-74	Heater Control Lens - w/o A/C		Nova	R-495
	69-74	Heater Control Lens - White - w/ A/C		Nova	R-496
	69-70	Heater Control Lens - w/ Backing Plate - w/o A/C		Nova	WV-497
	69-70	Heater Control Lens - w/ Backing Plate - w/ A/C		Nova	WV-497A
	71-74	Heater Control Lens - w/o A/C		Nova	R-497
	71-74	Heater Control Lens - w/ A/C		Nova	R-498
	69-74	Heater Lens - w/o A/C		Nova	K-K597
	69-74	Heater Lens - w/ A/C		Nova	K-K598
9	69-74	Heater Control Cables - 3pcs - w/ A/C		Nova	K-K573
10	62-74	Heater Control Knobs - Chrome - 4pcs		Chevy II Nova	R-426
11	69-79	Heater Control Lens Clips - 69-74 w/ A/C; 69-79 w/o A/C - 3pcs		Nova	R-410
12	69-74	Heater Fan Switch - w/o A/C		Nova	K-3967939
13	70-74	Heater Blower Switch - w/ A/C		Nova	K-3929093
14	62-79	Heater Box Blower Resistor Assembly		Chevy II Nova	R-315



VISIT US ONLINE FOR THE MOST UP-TO-DATE PRICING AND SELECTION



KNOBBS & BEZELS



#	YEAR	DESCRIPTION	GM	MODEL	PART #
1	69	Dash Knob Sets - Stereo - 7pcs		Nova	W-793
2	69	Dash Knob Sets - Mono - 7pcs		Nova	W-794
1	67	Radio Control Knobs - Chrome (Volume & Tuner) - 2pcs		Chevy II Nova	W-213
4	69-70	Radio Control Knobs - Mono - 4pcs		Nova	W-860
5	69-70	Radio Control Knobs - Stereo - 4pcs		Nova	W-517
6	69-70	Radio Control Knobs - Mono Inner (Tone & Dummy) - 2pcs		Nova	W-231
7	69-70	Radio Control Knobs - Stereo Inner (Tone & Fader) - 2pcs		Nova	W-231A
8	69-70	Radio Control Knobs - Outer (Volume & Tuner) - 2pcs		Nova	W-245
9	71-76	Radio Control Knobs - Outer - 2pcs (Volume & Tuning)		Nova, Ventura	K-330107
10	63-69	Radio Control Shaft Nuts - 2pcs		Chevy II Nova	W-588
11	65-79	Vent Pull Knobs - Black - 2pcs		Chevy II Nova	T-4561
12	67	Ignition Bezel Nut		Chevy II Nova	W-219
	62-65	Ignition Bezel Nut Removal Tool		Chevy II Nova	TOOL-23
13	66-67	Ignition Bezel Nut Removal Tool		Chevy II Nova	TOOL-27
	68	Ignition Bezel Nut Removal Tool		Chevy II Nova	TOOL-18

INTERIOR - SWITCHES



#	YEAR	DESCRIPTION	GM	MODEL	PART #
1	68	Neutral Safety/Back-up Lamp Switch - TH-400 w/ Console		Chevy II Nova	W-373A
2	68-70	Neutral Safety/Back-up Lamp Switch - Powerglide - For Models w/ Console ONLY		Chevy II Nova	W-373
3	70-79	Neutral Safety Switch		Nova	X417-3070-M
4	71-79	Stop Light Switch Retainer		Nova	R-203
5	65	Wiper Switch - 1spd w/ Washer		Chevy II	X460-3065-22
6	65-66	Wiper Switch - 2spd w/ Washer		Chevy II	X460-3065-23
7	67-68	Wiper Switch		Chevy II Nova	K-1993395
	67-68	Wiper Switch		Chevy II	X460-3067-21
8	69-71	Wiper Switch		Nova, Ventura	K-1993464
	69-71	Wiper Switch		Nova, Ventura II	X460-3069-21
9	72-74	Wiper Switch		All X-Body	X460-3072-21
10	67	Wiper Knob - Chrome		Chevy II Nova	W-214
11	68-74	Wiper Motor Arm w/ Ball Stud		Chevy II Nova	W-086
12	67	Wiper Switch Knob - Chrome		Chevy II Nova	W-214
13	69-71	Wiper Switch Knob - OE Style		Nova	W-578
	62-67	Wiper Arms - Silver		Chevy II Nova	X382-3567-2VP

VISIT US ONLINE FOR THE MOST UP-TO-DATE PRICING AND SELECTION



ASHTRAY & LIGHTER



#	YEAR	DESCRIPTION	GM	MODEL	PART #
1	68-74	Armrest Ashtray Assembly - Rear - 68-69 "Ribbed" 70 and up "Smooth"	Nova		W-641
2	68-74	Ashtray Insert - Rear Quarter	Nova		W-255
3	69-74	Ashtray Receiver	Nova		W-486
4	68-75	Console or Ashtray Lid Bumpers - 2pcs	Chevy II Nova		W-534
5	67	Lighter Knob - Rochester Type	Chevy II Nova		W-298
6	69	Lighter Knob - Rochester Type	Nova		W-421
7	69	Lighter Knob & Element - Rochester Type	Nova		W-421A
8	67	Lighter Housing Element - Rochester Type	Chevy II Nova		W-298B
9	67-69	Lighter Heating Element, Insulator & Shield Assembly - Rochester Type	Chevy II Nova		W-298B
10	62-79	Lighter Housing - Rochester Type	Chevy II Nova		W-421C
11	62-79	Lighter Receptacle - Rochester Type	Chevy II Nova		W-421E

GLOVEBOX



#	YEAR	DESCRIPTION	GM	MODEL	PART #
1	62-65	Glove Box Liner	Chevy II Nova		R-N101
2	66-67	Glove Box Liner	Chevy II Nova		R-N102
3	69-79	Glove Box Liner - w/ A/C	Nova		R-N103
4	69-79	Glove Box Liner - w/o A/C	Nova		R-N104
5	62-79	Glove Box Door Stop Bumper	Chevy II Nova		R-280
6	62-87	Glove Box Door Bumper - Use 2 per vehicle	Chevy II Nova		X461-3062-5
7	66-67	Glove Box Door Hinge Screws - 3pcs	Chevy II Nova		R-202



VISIT US ONLINE FOR THE MOST UP-TO-DATE PRICING AND SELECTION



STEERING WHEEL



#	YEAR	DESCRIPTION	GM MODEL	PART #
1	67	Steering Wheel Set - Black	Chevy II Nova SS	X459-3467-BLKS
2	67	Steering Wheel and Shroud - Black	Chevy II Nova SS	X459-3467-BLK
3	68	Steering Wheel and Shroud - Black-Brushed Chrome - w/ Custom Interior	Chevy II Nova	X459-3568-1BLK
4	67-68	Steering Wheel - Walnut Woodgrain	Chevy II	X459-3567-4
5	69	Steering Wheel - Black	Nova	X459-3569-1BLK
	69	Steering Wheel - Medium Blue	Nova	X459-3569-1BLU
	69	Steering Wheel - Dark Green	Nova	X459-3569-1DGN
	69	Steering Wheel - Red	Nova	X459-3569-1RED
6	71-72	Steering Wheel - Black 4-Spoke Sport Wheel	Nova	X459-3571-3BLK
7	68-69	Steering Wheel Mounting Screw - Woodgrain - 6pcs	Chevy II Nova	WV-225
8	69	Steering Wheel Shroud - Black	Nova	X459-3569-2BLK
	69	Steering Wheel Shroud - Blue	Nova	X459-3569-2BLU
	69	Steering Wheel Shroud - Dark Green	Nova	X459-3569-2DGN
	69	Steering Wheel Shroud - Red	Nova	X459-3569-2RED
	69	Steering Wheel Shroud - Black	Nova	X459-3569-4BLK
9	69	Steering Wheel Horn Buttons - Black Pair	Nova	X459-3569-3BLKP
	69	Steering Wheel Horn Buttons - Blue Pair	Nova	X459-3569-3BLUP
	69	Steering Wheel Horn Buttons - Dark Green Pair	Nova	X459-3569-3DGNP
	69	Steering Wheel Horn Buttons - Red Pair	Nova	X459-3569-3REDP
10	69-70	Steering Wheel Shroud Screw Set - 6 pcs	Nova	X459-3569-2AS
	67-68	Steering Wheel Mounting Hub	Chevy II Nova	X459-3567-4A



VISIT US ONLINE FOR THE MOST UP-TO-DATE PRICING AND SELECTION



Officially Licensed GM Parts



WARNING: Cancer and Reproductive Harm - www.P65Warnings.ca.gov

WWW.AUTOMETALDIRECT.COM

833.404.4445

235



VISIT US ONLINE FOR THE MOST UP-TO-DATE PRICING AND SELECTION



#	YEAR	DESCRIPTION	GM MODEL	PART #
1	67-68	Steering Wheel Horn Cap Assembly	Chevy II	X459-3567-4C
	69	Steering Wheel Horn Buttons - Black Pair	Nova	X459-3569-3BLKP
	69	Steering Wheel Horn Buttons - Blue Pair	Nova	X459-3569-3BLUP
	69	Steering Wheel Horn Buttons - Dark Green Pair	Nova	X459-3569-3DGNP
	69	Steering Wheel Horn Buttons - Red Pair	Nova	X459-3569-3REDP
2	69-70	Steering Wheel Horn Button Contacts - Pair	Nova	X459-3569-3AP
3	66-70	Steering Wheel Horn Cap Mounts/Contact Assembly - Wood Steering Wheel	Chevy II Nova	W-617
4	67-68	Steering Wheel Horn Cap Mounting & Contact Assembly - w/ Hardware (1" inner) - Wood Steering Wheel	Chevy II Nova	W-657
5	68	Steering Wheel Horn Cap - Standard & Deluxe - Polished Chrome w/ "SS" Insert - RS or SS	Chevy II Nova SS	W-179B
6	68-70	Steering Wheel Horn Cap Mounting & Contact Assembly - w/ Hardware (1" inner) - Non-Tilt Steering Wheel	Chevy II Nova	W-658
	68-70	Steering Wheel Horn Cap Mounting & Contact Assembly - w/ Hardware (1" inner) - Tilt Steering Wheel	Chevy II Nova	W-659
7	67-68	Steering Wheel Horn Cap Mounting Set - Fits Wood or Cushion Grip Wheels	Chevy II Nova	R-205
8	68	Steering Wheel Horn Cap Rubber Mounting Ring	Chevy II Nova	W-180
9	71-72	Steering Wheel Horn Cap - Black 4-Spoke Sport Wheel	Nova	X459-3571-4BLK
10	71-72	Steering Wheel Horn Cap Retainer - 4-Spoke Sport Wheel	Nova	X459-3571-5
11	71-72	Steering Wheel Horn Cap Emblems - 'bowtie' with 4-Spoke Sport Wheel	Nova	X459-3571-6
12	69	Steering Wheel Horn Shroud Emblem - Blue Bowtie	Nova	X459-3569-2A
13	73-79	Steering Wheel Tilt Release Lever - w/ Black Knob	Nova	X458-3071-1
14	67	Steering Column Shim - Wedge	Chevy II Nova	W-423
15	68-74	Steering Column to Floor Boot	Chevy II Nova	W-445
16	62-79	Steering Coupler Bolt - 12 Pt.	Chevy II Nova	H-160
17	68-74	Steering Coupler Repair Set	Chevy II Nova	W-550



COOL. QUIET. COMFORTABLE.

WHEN THE METAL WORK IS DONE, YOU HAVE TO CONTROL THE HEAT & SOUND WITH HIGH QUALITY MATERIALS



BOOM MAT

Thermal Acoustic Control

DAMPING MATERIAL

CONTROLS NOISE AND VIBRATION
MAKES INTERIORS QUIET
PREVENTS SQUEAKS & RATTLES

UNDER CARPET LITE

HI-TECH REPLACEMENT FOR JUTE/PADDING
BLOCKS 85% OF HEAT
ABSORBS SOUNDS MAKING CABINS QUIET

CUSTOM CUT KITS

PRE-CUT INSULATION KITS
FOR FIRST GEN CAMARO/FIREBIRD
READY TO GO HEAT & SOUND CONTROL KITS
TAKES THE GUESS WORK OUT OF WHAT YOU
NEED TO MAKE YOUR TRUCK COOL & QUIET

ATAC FAMILY

ALL IN ONE FAMILY OF PRODUCTS AND COATINGS
DESIGNED TO TAKE THE GUESS WORK OUT OF
INTERIOR HEAT & SOUND CONTROL.

ATAC - 1-STEP SOLUTION TO CONTROL HEAT & SOUND

SEAM SEALER - SEAL OUT AIR GAPS & MOISTURE

RED OXIDE PRIMER - ENCAPSULATE RUST AND PREP
SURFACES FOR ATAC COATING



DESIGNENGINEERING.COM • 800-264-9472

CONSOLE



11



26



27

19	YEAR	DESCRIPTION	GM	MODEL	PART #
1	68-72	Console Housing		Chevy II Nova	W-481
2	68-74	Console Plate - w/ Hardware		Chevy II Nova, Ventura	W-620B
3	67-76	Console Plate & Gauge Mounting Bracket Set - 12pcs		Chevy II Nova, Ventura	W-739
	68	Console Forward - Woodgrain Insert - Gunstock Walnut		Chevy II Nova	R-N139W
	69-70	Console Forward - Woodgrain Insert - Rosewood		Chevy II Nova	R-N139R
4	68-74	Console Shift Plates - 2pcs - A/T Shifter Plates		Chevy II Nova, Ventura	W-841
5	68-74	Console Shift Plate - 4-Spd. - M/T Shifter Plates		Chevy II Nova	W-792
6	68-69	Console Shift Plate Slider		Chevy II Nova	W-374
7	68-74	Console Shift Plate Slider Retainer - Auto or Manual Trans - Pair		Chevy II Nova	W-340A
8	68-74	Console Shift Plate Lamp Holder - Auto Trans		Chevy II Nova	W-627
9	68-74	Console Shift Plate Lens Backing Plate - Auto Trans		Chevy II Nova,	W-626
10	68-76	Console Gauge Connector Set - w/ Nut		Chevy II Nova, Ventura	W-202
11	68-76	Console Gauge Hardware Set		Chevy II Nova, Ventura	W-202A
12	68-76	Console Gauge Bezel - w/ Chrome Trim		Chevy II Nova, Ventura	W-026
13	68-74	Console Floor Shift Hump - 3 or 4 Speed		Chevy II Nova, Ventura II	W-481B
14	68-74	Console Floor Bracket		Chevy II Nova	W-481A
15	65-67	Shifter Slider Seal - 4-Spd. w/ Console		Chevy II Nova	K-3863574
16	64-67	Shifter Slider Seal - Auto Trans w/ Console		Chevy II Nova	K-3878480
17	68-72	Shifter Assembly - Console Models ("Muncie" Embossed on Lever)		Chevy II Nova	K-3934286
18	68-69	Shift Boot - w/ Console		Nova	X416-3567-3
19	70-73	Shift Boot - M/T w/ Console		Nova, Ventura	R-241
20	62-67	Shift Boot Retainer - Chrome - 4-Spd		Chevy II Nova	K-3849852
	68-72	Shift Boot Retainer - M/T w/ Console		Chevy II Nova	W-256
21	68-70	Shift Ball - Black/Chrome - 4-Speed Muncie, 5/16" Thread		Chevy II Nova	W-157B
	71-74	Shift Indicator Dial - Turbo - Blue & White		Nova	W-812
23	68-69	Shift Indicator Lens - Powerglide		Chevy II Nova	W-109
	68	Shift Indicator Lens - Green - Turbo		Chevy II Nova	W-127
24	64-67	Floor Shift Knob - 4-Spd - 5/16" Thread		Chevy II Nova	W-183B
25	68-76	Floor Shifter Hole Reinforcement Ring - 3 & 4 Speed		Chevy II Nova	W-482
26	68-76	Fuel Oil Gauge Mount Plate - Front - Blue		Chevy II Nova	W-106C
27	67	30-Amp Circuit Breaker		Chevy II Nova	W-559

VISIT US ONLINE FOR THE MOST UP-TO-DATE PRICING AND SELECTION



TURN SIGNAL



#	YEAR	DESCRIPTION	GM MODEL	PART #
1	62	Turn Signal Lever - w/ Black Knob	Chevy II	X458-4061
	63-64	Turn Signal Lever & Knob	Chevy II Nova	458-4063-1
	66	Turn Signal Lever - w/ Black Knob - w/o Tilt Wheel	Chevy II Nova	X458-3464
	67	Turn Signal Lever - w/ Black Knob	Chevy II	X458-3067
2	67	Turn Signal Lever - Black Knob	Chevy II Nova	W-216
	68-70	Turn Signal Lever - w/ Black Knob	Chevy II Nova	X458-3068
	68-70	Turn Signal Lever - Black Knob	Chevy II Nova	W-217
	71-79	Turn Signal Lever - w/ Black Knob	All X-Body	X458-3071
	63-64	Turn Signal Switch	Chevy II	X458-3063
	64-65	Turn Signal Switch	Chevy II	X458-3064
	68	Turn Signal Switch - w/o Tilt Wheel - Metal Housing w/ Plastic Cam	Chevy II	X458-3464-A
	66	Turn Signal Switch - w/o Tilt Wheel - Plastic Housing w/ Plastic Cam	Chevy II	X458-3464-B
3	67-68	Turn Signal Switch - Delco Type - w/o Tilt Wheel	Chevy II	X458-3067-3A
	69-79	Turn Signal Switch - w/ or w/o Tilt Wheel	Nova, Ventura	X458-3069-3
	62-65	Turn Signal Cancelling Cam	Chevy II	X458-3062
	67-71	Hazard Lamp Switch Knob	Chevy II Nova	X458-3067-2

ACCELERATOR PEDAL



#	YEAR	DESCRIPTION	GM MODEL	PART #
	62-67	Accelerator Pedal Pad	Chevy II Nova	X409-3062
1	68-79	Accelerator Pedal Pad	All X-Body	409-4076
2	68-77	Accelerator Pedal Pad Trim	Nova, Ventura	W-132
3	68-79	Accelerator Pedal Tension Spring	Nova	W-565
4	68-74	Accelerator Pedal Rod Pin	Chevy II Nova	W-571
5	68-72	Accelerator Lever Firewall Support	Chevy II Nova	W-675



VISIT US ONLINE FOR THE MOST UP-TO-DATE PRICING AND SELECTION





PEDAL PAD/TRIM SET



3



4



5



6



7



8

N	YEAR	DESCRIPTION	GM	MODEL	PART #
1	68-70	Complete Gas Pedal Assembly Through Firewall - w/ Pad and Trim - V8		Chevy II Nova	W-572
2	68-70	Complete Gas Pedal Assembly Through Firewall - w/o Pad or Trim - V8		Nova	W-687
	68-70	Complete Gas Pedal Assembly Through Firewall - w/ Pad and Trim, w/ Cable Control - L4 or L6		Chevy II Nova	X409-3567-1
	68-72	Complete Gas Pedal Assembly Through Firewall - w/ Pad w/o Trim - V8		Chevy II Nova	W-584
3	68	Pedal Pad & Trim Set - Manual Trans w/ Disc Brakes		Chevy II Nova	W-880
	68	Pedal Pad & Trim Set - Manual Trans w/ Standard Brakes		Chevy II Nova	W-881
4	68	Pedal Pad & Trim Set - Auto Trans w/ Disc Brakes		Chevy II Nova	W-884
	68	Pedal Pad & Trim Set - Auto Trans w/ Standard Brakes		Chevy II Nova	W-885
5	69-72	Pedal Pad & Trim Set - Manual Trans w/ Disc Brakes		Nova	W-882
	69-72	Pedal Pad & Trim Set - Manual Trans w/ Standard Brakes		Nova	W-883
6	69-74	Pedal Pad & Trim Set - Auto Trans w/ Disc Brakes		Nova, Ventura	W-886
	69-74	Pedal Pad & Trim Set - Auto Trans w/ Standard Brakes		Nova, Ventura	W-887
7	73-79	Pedal Pad Set - w/ Trim & Disc Brake Emblem - Manual		Nova, Ventura	W-842
	73-79	Pedal Pad Set - w/ Trim - Manual		Nova, Ventura	W-843
8	69-74	Pedal Support Hanger Bracket		Nova, Ventura	W-011



BRAKE/CLUTCH PEDAL



#	YEAR	DESCRIPTION	GM	MODEL	PART #
1	68-74	Brake & Clutch Pedal Assembly		Chevy II Nova, Ventura	W-598
3	62-67	Brake & Clutch Pedal Pad - Horizontal Ribs - w/o Power Brake Lettering		Chevy II Nova	K-6256368
4	62-79	Brake & Clutch Pedal Bushings - 4pcs		Chevy II Nova	W-083
5	63-72	Brake & Clutch Pedal to Rod Clip		Chevy II Nova	W-597A
6	68-72	Brake Pedal Assembly - Auto Trans		Chevy II Nova	W-831
8	62-67	Brake Pedal Pad - A/T w/ Power Brakes Lettering	W	Chevy II Nova	X476-3958-APB
9	62-67	Brake Pedal Pad		Chevy II	X476-3958-A
10	68-71	Brake Pedal Pad - M/T w/ Disc Brake Emblem		Nova	W-120
11	68-79	Brake Pedal Pad Trim - A/T Stainless		Chevy II Nova, Ventura	W-133
12	68-79	Brake Pedal Pad - A/T w/ Disc Brake Emblem		All X-Body	W-163
13	68-77	Brake Pedal Pad - A/T w/o Disc Brakes emblem		Chevy II Nova	W-236
14	68-79	Brake or Clutch Pedal Pad - Stainless Trim		Chevy II Nova, Ventura	W-192
15	68-79	Brake or Clutch Pedal Pad		Chevy II Nova	W-191
16	62-76	Brake Pedal Pivot Pin - Auto Trans		Chevy II Nova	W-628
18	73-79	Clutch Pedal Trim - Stainless		Ventura	W-752
19	73-79	Clutch Pedal Pad		Nova, Ventura	W-204



VISIT US ONLINE FOR THE MOST UP-TO-DATE PRICING AND SELECTION



Officially Licensed GM Parts



WARNING: Cancer and Reproductive Harm - www.P65Warnings.ca.gov

WWW.AUTOMETALDIRECT.COM

833.404.4445

241

CLUTCH SHIFT LINKAGE

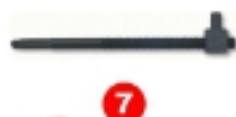

#	YEAR	DESCRIPTION	GM MODEL	PART #
1	68-72	Clutch Linkage Set - Small Block	Chevy II Nova, Ventura	WV-685
2	68-72	Clutch Linkage Set - Big Block	Chevy II Nova, Ventura	WV-781
3	62-74	Clutch Bellcrank Pivots - 4pcs	Chevy II Nova, Ventura	WV-686A
4	62-74	Clutch Bellcrank felt Seals - 2pcs	Chevy II Nova, Ventura	WV-686B
5	68-72	Clutch Bellcrank Assembly - Small Block	Chevy II Nova, Ventura	WV-686
6	68-72	Clutch Bellcrank Assembly - Big Block	Chevy II Nova, Ventura	WV-780
7	68-70	Clutch Push Rod - w/ Swivel - Lower - Big Block	Chevy II Nova	K-9779202
8	68-72	Clutch Push Rod - Upper	Chevy II Nova, Ventura	WV-194
9	68-72	Clutch Push Rod - Lower Adjustable - 3pcs	Chevy II Nova, Ventura	WV-209
10	68-75	Clutch Push Rod Upper Firewall Boot	Chevy II Nova, Ventura	WV-239
11	68-79	Clutch Rod Firewall Cover & Seal Set	Chevy II Nova, Ventura	WV-769
12	68-72	Clutch Adjusting Rod - Lower - w/ Swivel - Big Block	Chevy II Nova, Ventura	WV-783
13	68-72	Clutch Extension Rod - Small Block	Chevy II Nova, Ventura	WV-146
14	68-72	Clutch Return Spring - Small Block	Chevy II Nova, Ventura	WV-146A
15	68-72	Clutch Return Spring - Big Block	Chevy II Nova, Ventura	WV-146C
16	68-72	Clutch Return Spring Extension - Big Block	Chevy II Nova, Ventura	WV-782
17	62-72	Clutch Pivot Stud - Frame Side	Chevy II Nova, Ventura	WV-201
18	62-74	Clutch Pivot Stud - Block Side	Chevy II Nova, Ventura	WV-200
19	68-74	Clutch Pivot Mounting Bracket - Frame Side	Chevy II Nova, Ventura	WV-208
20	70-74	Clutch Pivot Ball Stud - Frameside	Nova, Ventura	WV-319
21	68-72	Clutch Fork	Chevy II Nova, Ventura	WV-692
22	68-79	Bellhousing to Clutch Fork Boot	Chevy II Nova, Ventura	WV-478
23	69-72	Lockout Linkage Set - Small Block Muncie 4-Spd	Nova, Ventura	WV-914A
24	69-72	Lockout Bellcrank Assembly - 4-Spd	Nova, Ventura	WV-913
25	67-72	Kickdown Rod - w/ Swivel - Powerglide w/ 2BBL	Chevy II Nova, Ventura	WV-666
	67-72	Kickdown Rod - w/ Swivel - Powerglide w/ 4BBL	Chevy II Nova, Ventura	WV-667

VISIT US ONLINE FOR THE MOST UP-TO-DATE PRICING AND SELECTION



PARKING BRAKE



#	YEAR	DESCRIPTION	GM	MODEL	PART #
1	68-79	Parking Brake Assembly	Chevy II	Nova, Ventura	X377-3567
2	69-79	Parking Brake Pedal Pad Trim	Chevy II	Nova, Ventura	W-108
3	68	Parking Brake Pedal Pad w/ "PARK" Logo	Chevy II	Nova	W-229
4	69-79	Parking Brake Pedal Pad Trim	Nova, Ventura		W-122
5	69-79	Parking Brake Pedal Pad - Small	Nova, Ventura		W-230
6	62-74	Parking Brake Adjustment Nuts - 2pcs	Chevy II	Nova, Ventura	W-904
7	64-79	Parking Brake Horizontal Guide Bar - LH or RH	Chevy II	Nova, Ventura	R-512
8	64-79	Parking Brake Guide Bar Springs - Pair	Chevy II	Nova, Ventura	R-513
9	64-79	Parking Brake Lever Set - LH	Chevy II	Nova, Ventura	R-514
	64-79	Parking Brake Lever Set - RH	Chevy II	Nova, Ventura	R-515
10	68-71	Parking Brake Equalizer	Chevy II	Nova, Ventura	W-902
11	68-71	Parking Brake Front Cable - OE Style	Chevy II	Nova, Ventura	W-330
12	68-75	Parking Brake Rear Cable	Chevy II	Nova, Ventura	W-854
13	68-74	Parking Brake Cable Frame Guide	Chevy II	Nova, Ventura	W-397
14	62-65	Parking Brake Release Handle - Black	Chevy II		X441-3062
15	66-67	Parking Brake Release Handle - Black	Chevy II		X441-3066
16	68-79	Parking Brake Release Handle - Chrome	Chevy II	Nova, Ventura	441-4066
17	68-79	Parking Brake Release Handle - Black	All X-Body		441-4067
18	68-79	Parking Brake Connector - Rear - Pair	Chevy II	Nova, Ventura	W-903



SEAT

VISIT US ONLINE FOR THE MOST UP-TO-DATE PENDING AND SELECTION



#	YEAR	DESCRIPTION	GM	MODEL	PART #
1	69-71	Bucket Seat Floor Brackets	Nova, Ventura	II	407-3068-S
2	62-68	Bench Seat Back Stoppers - 2pcs	Chevy II	Nova	W-387
3	67-72	Bench Seat Hinge Arm Covers - Pair	Chevy II	Nova, Ventura	W-690
4	67-79	Seat Belt Retractor & Lap Belt to Floor Tunnel Bolt	Chevy II	Nova	W-590
5	69-72	Seat Belt Shoulder Belt Retainers - 8pcs	Nova		W-732
6	67-79	Seat Belt Bolt - Rear - Cad Plated w/ Sealant	All X-Body		W-592
7	67-79	Seat Belt Bolt - Inner - For Front Lap & Shoulder Belts	All X-Body		W-591
8	67-72	Seat Hinge Arm Fastener Clips - 4pcs	Chevy II	Nova, Ventura	W-690A

HARDWARE - CHASSIS



Images for reference only. Actual parts will vary depending on application.

#	YEAR	DESCRIPTION	GM	MODEL	PART #
1	64-65	Master Chassis Hardware Set - 283/327 w/ Drum Brakes - 448pcs	Chevy II	Nova	H-64NS-SB
	66	Master Chassis Hardware Set - 283/327 w/ Drum Brakes - 443pcs	Chevy II	Nova	H-66NS-SB
	67	Master Chassis Hardware Set - 283/327 w/ Disc Brakes - 454pcs	Chevy II	Nova	H-67NS-DCSB
	67	Master Chassis Hardware Set - 283/327 w/ Drum Brakes - 449pcs	Chevy II	Nova	H-67NS-DRSB
	68	Master Chassis Hardware Set - 307/327/350 w/ Drum Brakes & Multi-Leaf Springs - 338pcs	Chevy II	Nova	H-68NS-DRSB1
	68	Master Chassis Hardware Set - 307/327/350 w/ Drum Brakes & Multi-Leaf Springs - 336pcs	Chevy II	Nova	H-68NS-DRSB4
	68	Master Chassis Hardware Set - 307/327/350 w/ Disc Brakes & Multi-Leaf Springs - 345pcs	Chevy II	Nova	H-68NS-DCSB1
	68	Master Chassis Hardware Set - 307/327/350 w/ Disc Brakes & Multi-Leaf Springs - 343pcs	Chevy II	Nova	H-68NS-DCSB4
	68	Master Chassis Hardware Set - 396 w/ Disc Brakes & Multi-Leaf Springs - 344pcs	Chevy II	Nova	H-68NS-BB
	69	Master Chassis Hardware Set - 307/350 w/ Drum Brakes & Multi-Leaf Springs - 348pcs	Nova		H-69NS-DRSB1
	69	Master Chassis Hardware Set - 307/350 w/ Drum Brakes & Multi-Leaf Springs - 352pcs	Nova		H-69NS-DRSB4
	69	Master Chassis Hardware Set - 307/350 w/ Disc Brakes & Multi-Leaf Springs - 345pcs	Nova		H-69NS-DCSB1
	69	Master Chassis Hardware Set - 307/350 w/ Disc Brakes & Multi-Leaf Springs - 351pcs	Nova		H-69NS-DCSB4
	69	Master Chassis Hardware Set - 396 w/ Disc Brakes & Multi-Leaf Springs - 352pcs	Nova		H-69NS-BB
	70	Master Chassis Hardware Set - 307/350 w/ Drum Brakes & Multi-Leaf Springs - 346pcs	Nova		H-70NS-DRSB1
	70	Master Chassis Hardware Set - 307/350 w/ Drum Brakes & Multi-Leaf Springs - 350pcs	Nova		H-70NS-DRSB4
	70	Master Chassis Hardware Set - 307/350 w/ Disc Brakes & Multi-Leaf Springs - 344pcs	Nova		H-70NS-DCSB1
	70	Master Chassis Hardware Set - 307/350 w/ Disc Brakes & Multi-Leaf Springs - 374pcs	Nova		H-70NS-DCSB4
	70	Master Chassis Hardware Set - 396 w/ Disc Brakes & Multi-Leaf Springs - 359pcs	Nova		H-70NS-BB
	71-72	Master Chassis Hardware Set - 307/350 w/ Drum Brakes & Multi-Leaf Springs - 353pcs	Nova		H-71NS-DRSB1
	71-72	Master Chassis Hardware Set - 307/350 w/ Drum Brakes & Multi-Leaf Springs - 349pcs	Nova		H-71NS-DRSB4
	71-72	Master Chassis Hardware Set - 307/350 w/ Disc Brakes & Multi-Leaf Springs - 356pcs	Nova		H-71NS-DCSB1
	71-72	Master Chassis Hardware Set - 307/350 w/ Disc Brakes & Multi-Leaf Springs - 378pcs	Nova		H-71NS-DCSB4

HARDWARE - BODY



Images for reference only. Actual parts will vary depending on application.

#	YEAR	DESCRIPTION	GM	MODEL	PART #
1	64	Master Body Hardware Set - 376pcs	Chevy II	Nova	H-64NB
	65	Master Body Hardware Set - 383pcs	Chevy II	Nova	H-65NB
	66	Master Body Hardware Set - 383pcs	Chevy II	Nova	H-66NB
	67	Master Body Hardware Set - 358pcs	Chevy II	Nova	H-67NB
	68	Master Body Hardware Set - 332pcs	Chevy II	Nova	H-68NB
	69	Master Body Hardware Set - 327pcs	Nova		H-69NB
	70	Master Body Hardware Set - 317pcs	Nova		H-70NB
	71-72	Master Body Hardware Set - 314pcs	Nova		H-71NB

ROOF



VISIT US ONLINE FOR THE MOST UP-TO-DATE PRICING AND SELECTION



#	YEAR	DESCRIPTION	GM	MODEL	PART #
1	66-67	Roof Skin - ZDR Coupe	Chevy II	Nova	X600-3066
2	62-64	Roof Rail Weatherstrips - Pair - Coupe	Chevy II	Nova	K-K441
	65	Roof Rail Weatherstrips - Pair - Coupe	Chevy II	Nova	J-4031
	66-67	Roof Rail Weatherstrips - Pair - Coupe	Chevy II	Nova	J-4005
3	62-63	Convertible Top Binding End Clip - w/ Screw	Chevy II	Nova	K-7614749
4	62-63	Convertible Top Cables - 2pcs	Chevy II	Nova	K-14724
	62-63	Convertible Top Latches - Pair	Chevy II	Nova	X625-3961-1P

FLOOR



VISIT US ONLINE FOR THE MOST UP-TO-DATE PRICING AND SELECTION



#	YEAR	DESCRIPTION	GM MODEL	PART #
1	62-67	Floor Pan Assembly - Includes Braces - Floor Shift A/T	Chevy II Nova	X400-3062-1S
2	68-74	Floor Pan - OE Style - w/ Braces	Chevy II Nova	400-3068
3	62-67	Floor Pan Half - Full Length - LH	Chevy II Nova	X405-3062-L
4	62-74	Floor Pan Half - Full Length - RH	Chevy II Nova	X405-3062-R
5	68-74	Floor Pan Half - Full Length - LH	Chevy II Nova	405-3068-L
6	68-74	Floor Pan Half - Full Length - RH	Chevy II Nova	405-3068-R
7	62-72	Floor Plug - w/o Notch	Chevy II Nova	427-3961



Officially Licensed GM Parts



WARNING: Cancer and Reproductive Harm - www.P69Warnings.ca.gov

WWW.AUTOMETALDIRECT.COM

833.404.4445

245



QUARTER PANEL

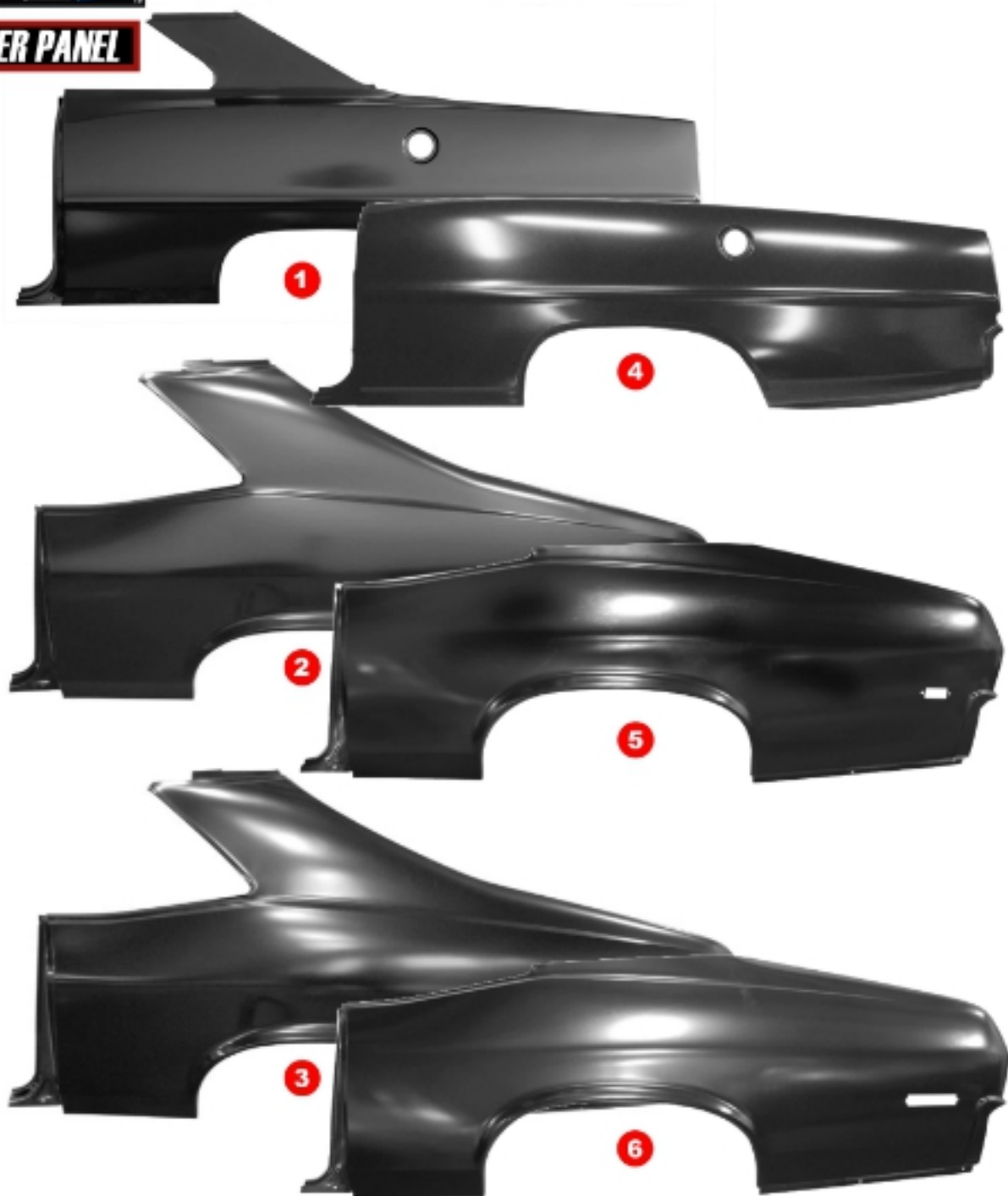

VISIT US ONLINE FOR THE MOST UP-TO-DATE PRICING AND SELECTION



#	YEAR	DESCRIPTION	GM	MODEL	PART #
1	66-67	Quarter Panel - OE Style - LH - Coupe		Chevy II Nova	700-3066-L
	66-67	Quarter Panel - OE Style - RH - Coupe		Chevy II Nova	700-3066-R
2	68-69	Quarter Panel - OE Style - LH		Chevy II Nova	700-3068-L
	68-69	Quarter Panel - OE Style - RH		Chevy II Nova	700-3068-R
3	70-72	Quarter Panel - OE Style - LH		Nova	700-3070-L
	70-72	Quarter Panel - OE Style - RH		Nova	700-3070-R
4	66-67	Quarter Panel Skin - w/ Door Jamb - LH		Chevy II Nova	710-3066-L
	66-67	Quarter Panel Skin - w/ Door Jamb - RH		Chevy II Nova	710-3066-R
5	68-69	Quarter Panel Skin - w/ Door Jamb - LH		Chevy II Nova	710-3068-L
	68-69	Quarter Panel Skin - w/ Door Jamb - RH		Chevy II Nova	710-3068-R
6	70-72	Quarter Panel Skin - w/ Door Jamb - LH		Nova	710-3070-L
	70-72	Quarter Panel Skin - w/ Door Jamb - RH		Nova	710-3070-R

WHEELHOUSE



1



2



3

#	YEAR	DESCRIPTION	GM	MODEL	PART #
1	68-72	Inner Wheelhouse - LH		Chevy II Nova	760-3068-L
	68-72	Inner Wheelhouse - RH		Chevy II Nova	760-3068-R
2	62-65	Outer Wheelhouse - except Convertible or Wagon (Post) - LH		Chevy II Nova, Ventura	X770-3062-L
	62-65	Outer Wheelhouse - except Convertible or Wagon (Post) - RH		Chevy II Nova, Ventura	X770-3062-R
3	68-74	Outer Wheelhouse - LH		Chevy II Nova, Ventura	770-3068-L
	68-74	Outer Wheelhouse - RH		Chevy II Nova, Ventura	770-3068-R

PACKAGE TRAY & DECK LID

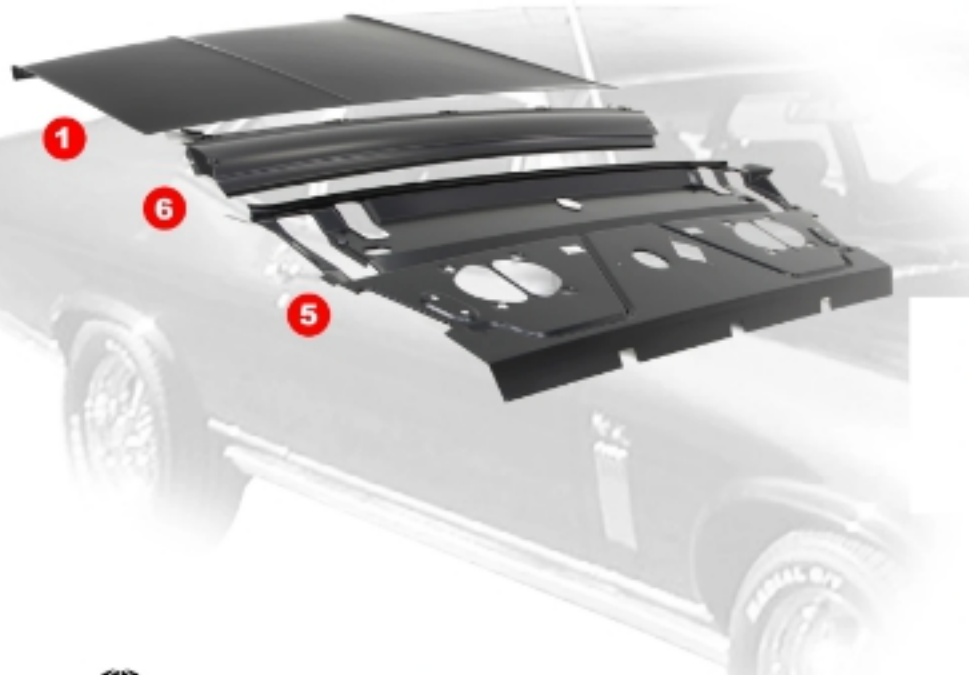

1

6

5



2



3



4

7



#	YEAR	DESCRIPTION	GM	MODEL	PART #
1	68-72	Package Tray		Chevy II Nova	640-3068
2	62-64	Deck Lid		Chevy II Nova	X850-3062
3	65	Deck Lid - w/ Back-up Light Holes		Chevy II Nova	850-3065
4	66-67	Deck Lid		Chevy II Nova	850-3066
5	68-74	Deck Lid		Chevy II Nova	850-3068
6	68-74	Deck Filler Panel - 2DR		Chevy II Nova	650-3068
7	66-67	Deck Filler Panel - 2DR Coupe		Chevy II Nova	X650-3066



VISIT US ONLINE FOR THE MOST UP-TO-DATE PRICING AND SELECTION



TRUNK



#	YEAR	DESCRIPTION	GM	MODEL	PART #
1	68-72	Trunk Floor - OE Style - w/ Braces - (71-72 Requires Mod.)		Chevy II Nova, Ventura Nova	800-3068 X806-3068
2	68-72	Trunk Floor Center Section (31"L x 38"W)			
3	68-72	Trunk Floor Extension - LH		Chevy II Nova, Ventura	840-3068-L
4	68-72	Trunk Floor Extension - RH		Chevy II Nova, Ventura	840-3068-R
5	68-72	Trunk Floor Extension End Cap - LH		Chevy II Nova, Ventura	841-3068-L
6	68-72	Trunk Floor Extension End Cap - RH		Chevy II Nova, Ventura	841-3068-R
7	62-65	Trunk Gutter Side Brace - LH		Chevy II	X826-3062-L
8	62-65	Trunk Gutter Side Brace - RH		Chevy II	X826-3062-R
9	68-69	Trunk Gutter Side Brace - LH		Chevy II Nova, Ventura	X826-3068-L
10	68-69	Trunk Gutter Side Brace - RH		Chevy II Nova, Ventura	X826-3068-R
11	68-69	Trunk Gutter Side Brace - LH		Chevy II Nova, Ventura	920-3068-L
12	68-69	Trunk Gutter Side Brace - RH		Chevy II Nova, Ventura	920-3068-R
13	70	Trunk Gutter Side Brace - LH		Nova	X826-3070-1L
14	70	Trunk Gutter Side Brace - RH		Nova	X826-3070-1R
15	71-72	Trunk Gutter Side Brace - LH		Nova, Ventura	826-3070-L
16	71-72	Trunk Gutter Side Brace - RH		Nova, Ventura	826-3070-R
17	62-72	Trunk Latch Assembly		Chevy II Nova, Ventura	W-029
18	73-74	Trunk Latch Assembly		Nova, Ventura	K-20291279
19	62-72	Trunk Latch Mounting Bolt Set		Chevy II Nova, Ventura	H-143
20	62-74	Trunk Lock Catch		Chevy II Nova, Ventura	854-3959
21	65-71	Trunk Lock Cylinder Gasket		Chevy II Nova, Ventura	K-4471426
22	67-74	Trunk Lock Gasket		Chevy II Nova, Ventura	K-K941
23	68-72	Trunk Lock Support		Chevy II Nova, Ventura	810-3068
24	71-74	Trunk Lock Striker		Nova, Ventura	854-3471
25	62-67	Trunk Lid Rubber Stopper		Chevy II Nova, Ventura	K-4721222
26	65-74	Trunk Weatherstrip		Chevy II Nova, Ventura	J-2003
27	73-74	Trunk Weatherstrip - Hatchback		Nova, Ventura	J-4013



VISIT US ONLINE FOR THE MOST UP-TO-DATE PRICING AND SELECTION



SPARE TIRE



1



2



3

#	YEAR	DESCRIPTION	GM	MODEL	PART #
1	65-74	Spare Tire Anchor Plate	92	All X-Body	K-20066400
2	67-74	Spare Tire Hold Down Rod		All X-Body	K-364993
3	67-74	Spare Tire Hold Down Nut		All X-Body	K-9785616

TAIL PANEL



1



2



3



4



5

#	YEAR	DESCRIPTION	GM	MODEL	PART #
1	62-64	Tailamp Panel Assembly		Chevy II	X900-3062-S
2	66-67	Tailamp Panel Assembly		Chevy II	X900-3066-S
3	68-69	Tailamp Panel		Nova	900-3068
4	70-72	Tailamp Panel		Nova	900-3070
5	73-74	Tailamp Panel Assembly		Nova	X900-3073



VISIT US ONLINE FOR THE MOST UP-TO-DATE PRICING AND SELECT



REVOLT

AUTO PAINT

HIGH QUALITY AUTO PAINT AND SUPPLIES AT REASONABLE PRICES, SHIPPED RIGHT TO YOUR DOOR. PERFECT FOR YOUR RESTORATION OR CUSTOM PROJECT. GREAT CUSTOMER SERVICE WITH ACTUAL HUMANS WHO KNOW PAINT. GIVE US A CALL OR VISIT THE WEBSITE FOR ANY INFORMATION.

WWW.REVOLTAUTOPAINT.COM

1-855-5-REVOLT



MAX GRUNDY'S COE IN "LOYALTY BLUE"



HIGH PERFORMANCE AUTO LEATHER

APEXLEATHER.COM | 1-800-402-7195



GAS TANK



#	YEAR	DESCRIPTION	GM MODEL	PART #
1	62-67	Gas Tank - 16 Gallon	Chevy II Nova	890-3062
2	68-69	Gas Tank - 16 Gallon - w/ Filler Neck	Chevy II Nova	890-3068-N
3	70	Gas Tank - 16 Gallon - w/ Filler Neck - w/o Vent Line	Nova	890-3070-N
4	70-72	Gas Tank - 16 Gallon - w/ Filler Neck - w/ 3 Vent Lines	All X-Body	890-3071-N
	73-74	Gas Tank - 21.5 Gallon - w/ Filler Neck	All X-Body	890-3073-N
5	75-79	Gas Tank - 21 Gallon - w/ Filler Neck	All X-Body	890-3075-N
6	75-79	Gas Tank - 21 Gallon - w/o Filler Neck	All X-Body	890-3574
7	62-67	Gas Tank Sending Unit - 5/16" Outlet - w/o Return Line	Chevy II Nova	881-3062-5
	66-67	Gas Tank Sending Unit - 3/8" Outlet - w/o Return Line	Chevy II Nova	881-3066-3
8	68-72	Gas Tank Sending Unit - 3/8" Outlet - w/o Return Line	Chevy II Nova	881-3569-3
9	66-67	Gas Tank Sending Unit - 5/16" single line	Chevy II Nova	K-6426499
10	68-72	Gas Tank Sending Unit - 5/16" Single Line	All X-Body	K-6428844
11	62-79	Gas Tank Sending Unit Lock Ring - 1 15/16" - Included w/ sending units	All X-Body	K-3774937
12	62-67	Gas Tank Straps - Pair	Chevy II Nova	X880-3062-P
13	68-72	Gas Tank Straps - Pair	All X-Body	X880-3068-P
14	73-79	Gas Tank Straps - Pair	All X-Body	X880-3073-P
15	62-64	Gas Cap - Vented - Black w/ Chrome Handle	Chevy II	X888-3062-B
	65-67	Gas Cap - Vented - Black w/ Chrome Handle	Chevy II	X888-3065-B
16	68-70	Gas Cap - Vented - w/o EEC	Nova	X888-3468
17	70	Gas Cap - Not Vented - w/ EEC	Nova	X888-1470
18	71-74	Gas Cap - Not Vented	All X-Body	X888-1471
19	67	Gas Tank Strap Hardware Set - 10 pcs	Chevy II Nova	X880-3567-S
20	62-67	Gas Tank Filler Neck to Body Seal	Chevy II Nova	J-40602

VISIT US ONLINE FOR THE MOST UP-TO-DATE PRICING AND SELECTION



WINDSHIELD

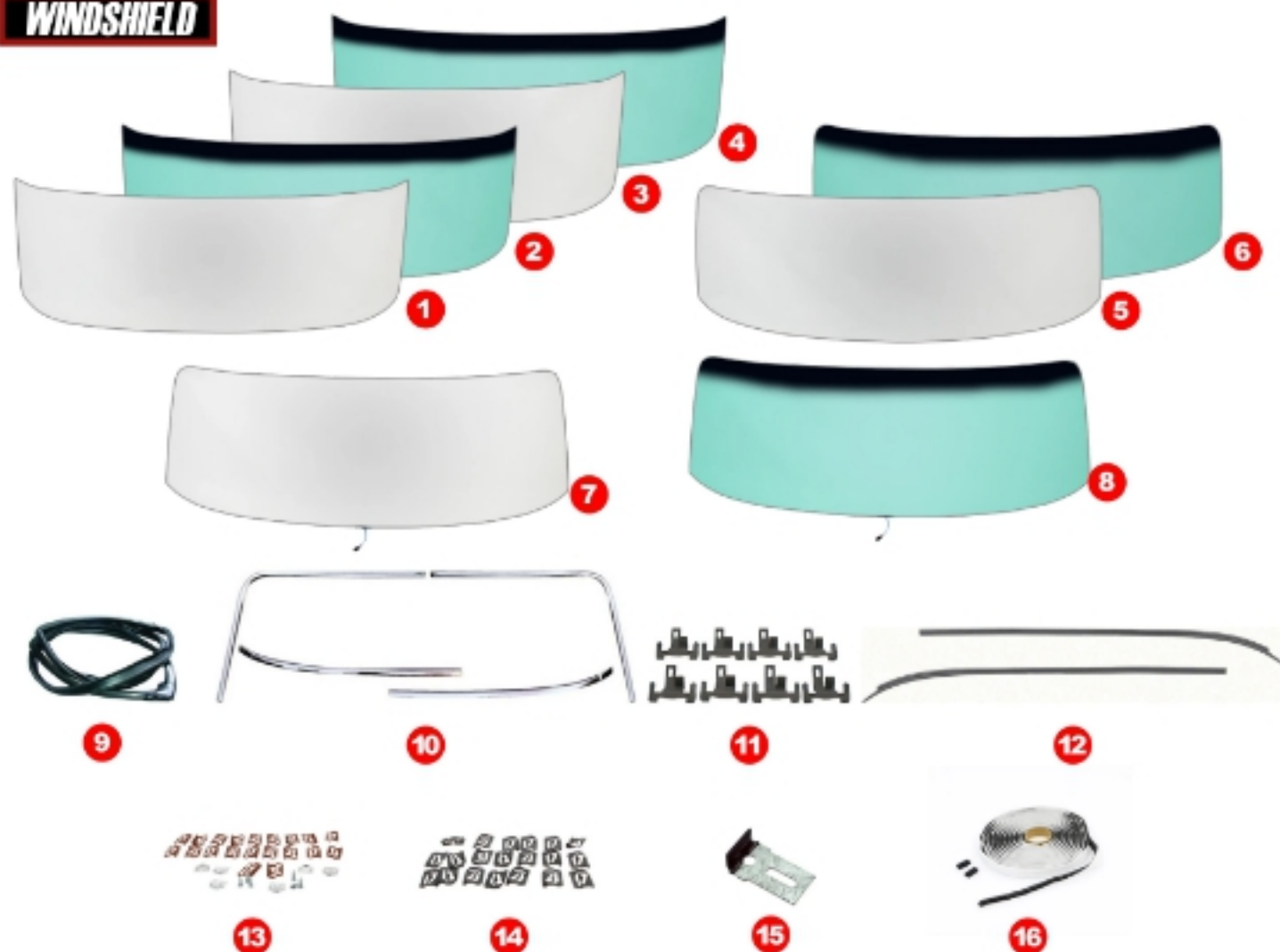

#	YEAR	DESCRIPTION	GM	MODEL	PART #
1	62-67	Windshield - Clear - Coupe & Convertible		Chevy II Nova	380-3062-C
2	62-67	Windshield - Green Tint - Coupe & Convertible		Chevy II Nova	380-3062-T
3	62-67	Windshield - Clear - 2/4DR Sedan		Chevy II Nova	380-3062-CS
4	62-67	Windshield - Green Tint - 2/4DR Sedan		Chevy II Nova	380-3062-TS
5	68-72	Windshield - w/o Antenna - Clear - Coupe		All X-Body	380-3068-C
6	68-69	Windshield - w/o Antenna - Green Tint - Coupe		All X-Body	380-3068-T
7	70-72	Windshield - w/ Antenna - Clear - Coupe		All X-Body	380-3070-C
8	70-72	Windshield - w/ Antenna - Green Tint - Coupe		All X-Body	380-3070-T
9	62-67	Windshield Gasket - w/ Trim Groove - 2/4DR Sedan & Wagon		Chevy II Nova	G-WCRD621
	62-67	Windshield Gasket - w/ Trim Groove - Hardtop		Chevy II Nova	G-WCRD622
10	68-74	Windshield Molding Set - 2DR Coupe		All X-Body	R-830
11	68-74	Windshield Lower Center Molding Clip Set - 8pcs		All X-Body	W-605
	68-74	Windshield Lower Center Molding Clip		All X-Body	W-605A
12	62-67	Windshield Trim Moldings - Interior Upper - Black - Pair		Chevy II Nova	K-K414
13	68-74	Windshield Molding Clips & Screw Set - Upper & Sides - 32pcs		All X-Body	X385-3068-115
14	68-74	Windshield Molding Clip Set - Upper & Sides - 32pcs		All X-Body	X385-3068-125
15	68-74	Windshield Stop Bracket - 2 Rqd.		All X-Body	W-648
16	66-72	Window Ribbon Seal - 3/8" x 15'		All X-Body	384-1000-3
	66-72	Window Ribbon Seal - 5/16" x 15'		All X-Body	384-1000-5



VISIT US ONLINE FOR THE MOST UP-TO-DATE PRICING AND SELECTION



BACK GLASS

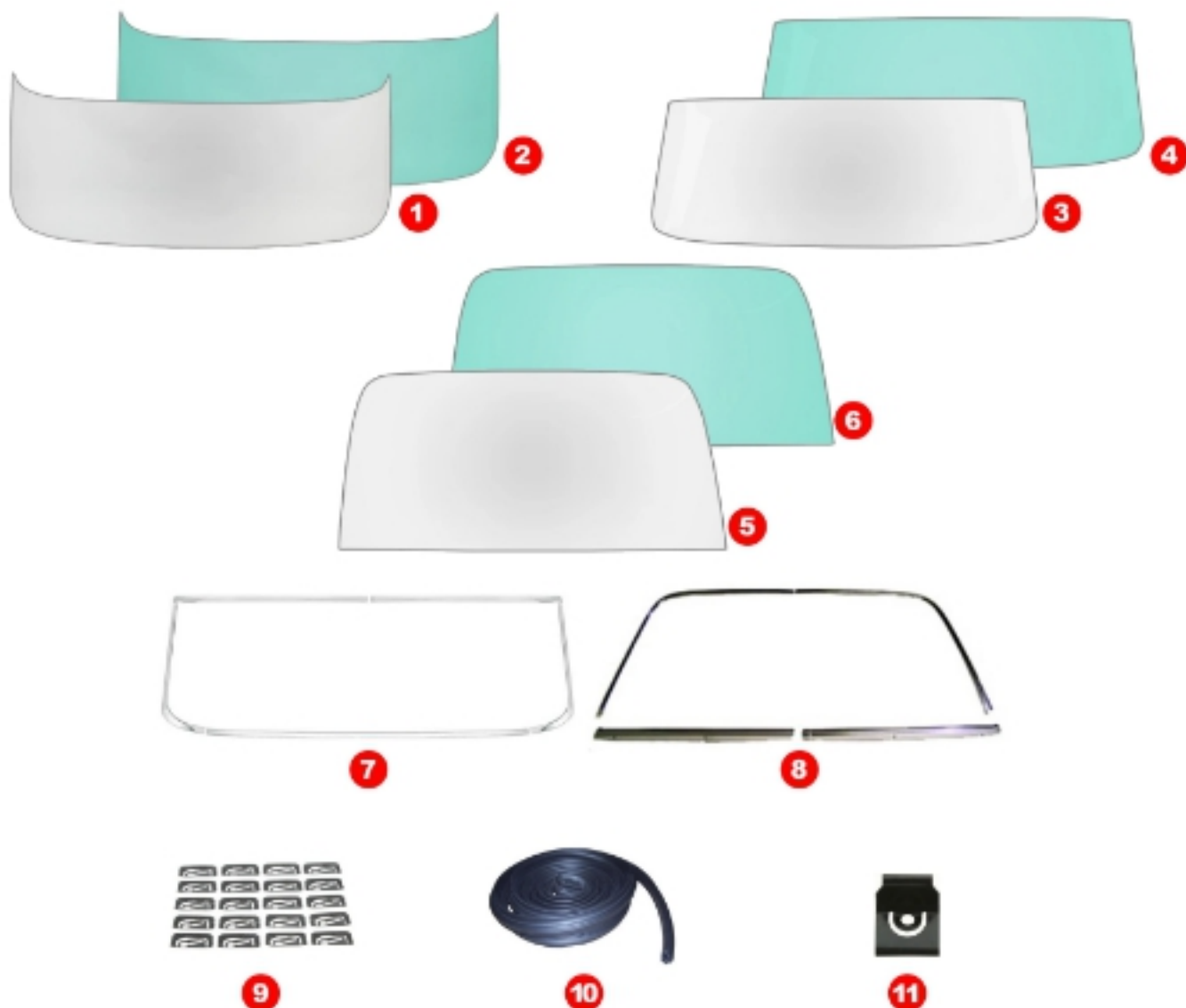

#	YEAR	DESCRIPTION	GM	MODEL	PART #
1	62-65	Back Glass - Clear - Coupe		Chevy II Nova	660-3062-C
2	62-65	Back Glass - Green Tint - Coupe		Chevy II Nova	660-3062-T
	62-65	Back Glass - Green Tint - Wagon		Chevy II Nova	660-3066-WT
3	66-67	Back Glass - Clear - Coupe		Chevy II Nova	660-3066-C
4	66-67	Back Glass - Green Tint - Coupe		Chevy II Nova	660-3066-T
5	68-72	Back Glass - Clear - Coupe (except Hatchback)		All X-Body	660-3068-C
6	68-72	Back Glass - Green Tint - Coupe (except Hatchback)		All X-Body	660-3068-T
7	66-67	Back Glass Molding Set - 2DR Hardtop		Chevy II Nova	X670-3066-2S
8	68-74	Back Glass Molding Set - 2DR Coupe		All X-Body	R-835
9	68-74	Back Glass Molding Clip Set - 2DR Coupe w/o Vinyl Top - 20pcs		All X-Body	X671-3066-1S
	68-74	Back Glass Molding Clip Set - 2DR Coupe w/ Vinyl Top - 20pcs		All X-Body	X671-3066-2S
	66-67	Back Glass Molding Clip Set - 2DR Hardtop - 24pcs		Chevy II Nova	X671-3066-S
	62-64	Back Glass Weatherstrip - With Trim Slot - 2 & 4-Door Sedan/Post		Chevy II Nova	G-WCRDB3127
	62-65	Back Glass Weatherstrip - With Trim Slot - 2-DR Coupe		Chevy II Nova	G-WCRDB3128
10	73-74	Back Glass Weatherstrip - Hatchback		All X-Body	J-4013
11	62-65	Rear Window Reveal Molding Clip - Hardtop - 28 rpd.		Chevy II Nova	K-4847515



VISIT US ONLINE FOR THE MOST UP-TO-DATE PRICING AND SELECTION



Officially Licensed GM Parts



WARNING: Cancer and Reproductive Harm - www.P65Warnings.ca.gov

WWW.AUTOMETALDIRECT.COM

833.404.4445

253

DOOR GLASS

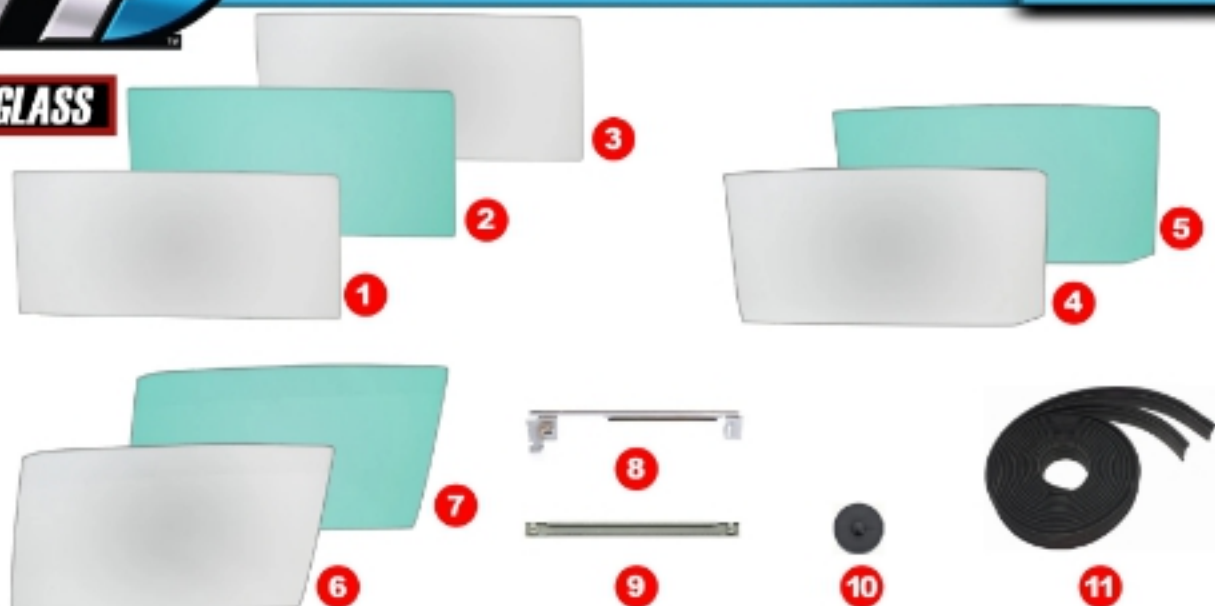

#	YEAR	DESCRIPTION	GM	MODEL	PART #
1	62-65	Door Glass - Clear - Coupe & Convertible - LH or RH	Chevy II	Nova	550-3062-C
2	62-65	Door Glass - Green Tint - Sport Coupe & Convertible - LH or RH	Chevy II	Nova	550-3062-T
3	62-67	Door Glass - Clear - 2DR Sedan (Post) - LH or RH	Chevy II	Nova	550-3062-CS
4	66-67	Door Glass - Clear - Sport Coupe - LH or RH	Chevy II	Nova	550-3066-C
5	66-67	Door Glass - Green Tint - Sport Coupe - LH or RH	Chevy II	Nova	550-3066-T
6	68-72	Door Glass - Clear - 2DR - LH	All	X-Body	550-3068-CL
	68-72	Door Glass - Clear - 2DR - RH	All	X-Body	550-3068-CR
7	68-72	Door Glass - Green Tint - 2DR - LH	All	X-Body	550-3068-TL
	68-72	Door Glass - Green Tint - 2DR - RH	All	X-Body	550-3068-TR
8	62-65	Door Glass Track - LH	Chevy II	Nova	X547-3062-2L
	62-65	Door Glass Track - RH	Chevy II	Nova	X547-3062-2R
9	62-67	Inner Door Sash - LH or RH - 2-DR	Nova		W-748D
10	68-69	Door Window Soap Bumper	All	X-Body	K-9810036
11	68-72	Door Window Channel Set - Coupe (Div Post and Glass Run) - 4pcs	All	X-Body	K-PW1098

QUARTER GLASS

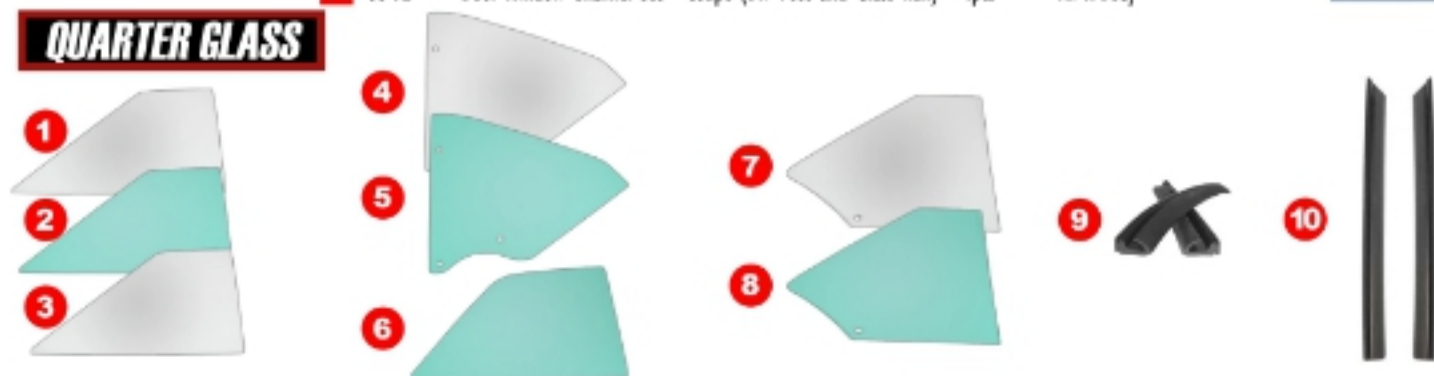

#	YEAR	DESCRIPTION	GM	MODEL	PART #
1	62-65	Quarter Glass - Clear - Coupe - LH or RH	Chevy II	Nova	795-3062-C
2	62-65	Quarter Glass - Green Tint - Coupe - LH or RH	Chevy II	Nova	795-3062-T
3	62-65	Quarter Glass - Clear - 2DR Sedan (Post) - LH or RH	Chevy II	Nova	795-3062-CS
4	66-67	Quarter Glass - Clear - Coupe - LH or RH	Chevy II	Nova	795-3066-C
5	66-67	Quarter Glass - Green Tint - Coupe - LH or RH	Chevy II	Nova	795-3066-T
6	66-67	Quarter Glass - Green Tint - 2DR Sedan (Post) - LH or RH	Chevy II	Nova	795-3066-TS
7	68-72	Quarter Glass - Clear - Coupe - LH	All	X-Body	795-3068-CL
	68-72	Quarter Glass - Clear - Coupe - RH	All	X-Body	795-3068-CR
8	68-72	Quarter Glass - Green Tint - Coupe - LH	All	X-Body	795-3068-TL
	68-72	Quarter Glass - Green Tint - Coupe - RH	All	X-Body	795-3068-TR
9	62-65	Quarter Window Vertical Seals - 2 DR Hardtop or Convertible - Pair	Chevy II	Nova	J-4032
	66-67	Quarter Window Vertical Seals - 2DR Hardtop - LH & RH	Chevy II	Nova	J-4033
10	66-67	Quarter Window Vertical Weatherstrips - w/ Steel Spine - 2DR Coupe - Pair	Chevy II	Nova	K-K447



VISIT US ONLINE FOR THE MOST UP-TO-DATE PRICING AND SELECTION



VENT GLASS

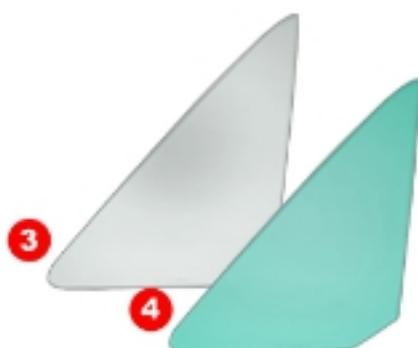
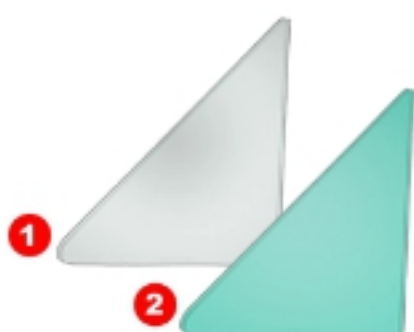

6

#	YEAR	DESCRIPTION	GM	MODEL	PART #
1	62-67	Vent Glass - Clear - LH or RH		Chevy II Nova	560-3062-C
2	62-67	Vent Glass - Green Tint - LH or RH		Chevy II Nova	560-3062-T
3	68-72	Vent Glass - Clear - LH		All X-Body	560-3068-CL
4	68-72	Vent Glass - Clear - RH		All X-Body	560-3068-CR
5	62-67	Vent Glass - Green Tint - LH		All X-Body	560-3068-TL
6	62-67	Vent Glass - Green Tint - RH		All X-Body	560-3068-TR
7	62-67	Vent Window Weatherstrips - Pair - Sedan & Wagon		Chevy II Nova	K-N4252
8	68-72	Vent Window Weatherstrip Set - Coupe		All X-Body	G-VWK121168
9	62-67	Vent Window Division Bar Channel - Pair		Chevy II Nova	J-2245
10	68-72	Vent Window Division Bar Channel - LH or RH		All X-Body	J-40403

GLASS COMPONENTS



1



4



6



#	YEAR	DESCRIPTION	GM	MODEL	PART #
1	62-65	Window Felts - Inner & Outer - Convertible - 8pcs		Chevy II Nova	R-N114A
2	62-65	Window Felts - Inner & Outer - 2DR Hardtop - 8pcs		Chevy II Nova	R-N115A
3	62-65	Window Felts - Inner & Outer - 2DR Sedan (Post) - 8pcs		Chevy II Nova	R-N117A
4	66-67	Window Felts - Inner & Outer - Coupe - 8pcs		Chevy II Nova	R-N118A
5	66-67	Window Felts - Inner & Outer - 2DR Sedan (Post) - 8pcs		Chevy II Nova	R-N119A
6	66-67	Window Felts - Inner & Outer - 4DR Sedan - 8pcs		Chevy II Nova	R-N120A
7	68-72	Window Felts - Inner & Outer - 2DR - 8pcs		All X-Body	R-N142A
8	66-67	Window Felts - Outer - 2DR Hardtop - 4pcs		Chevy II Nova	R-N156A
9	68-72	Window Felts - Outer - 2DR - 4pcs		All X-Body	R-N180A
10	66-68	Window Roller Guide Washer - 1 3/8" O.D.		All X-Body	K-4491086
11	62-72	Window Regulator Guide Cam Spacer		All X-Body	K-9804150
12	62-72	Wheel Opening Molding Screws - 36pcs		All X-Body	K-K606
13	62-65	Window Reveal Molding Clip Set - Rear - 2d Hardtop - 28 Pcd		Chevy II Nova	X671-3062-I
14	62-79	Window Reveal Molding Clips - 25pcs		All X-Body	10242
15	62-79	Window Clip and Reveal Molding Soud Replacement Set - 10Pcs		All X-Body	H-137
16	62-79	Window Clip and Reveal Molding Soud Replacement Set - 25Pcs		All X-Body	X385-3000-25



VISIT US ONLINE FOR THE MOST UP-TO-DATE PRICING AND SELECTION



Officially Licensed GM Parts



WARNING: Cancer and Reproductive Harm - www.P65Warnings.ca.gov

WWW.AUTOMETALDIRECT.COM

833.404.4445

255



HEADLIGHT



1



2



3



4



5



6



7



8



9



10



11



12

#	YEAR	DESCRIPTION	GM	MODEL	PART #
1	70-74	RetroBright LED Forward Facing Headlight Kit - Classic White 3000K 4X6 - HIGH-BEAM ONLY	All	X-Body	<u>X149-HR465S-30H</u>
2	68-69	RetroBright LED Forward Facing Headlight Kit - Classic White 3000K 4X6 - LOW-HIGH BEAM	All	X-Body	<u>X149-HR465S-30L</u>
3	70-74	RetroBright LED Forward Facing Headlight Kit - Bright White 5700K 4X6 - HIGH-BEAM ONLY	All	X-Body	<u>X149-HR465S-57H</u>
4	68	RetroBright LED Forward Facing Headlight Kit - Bright White 5700K 4X6 - LOW-HIGH BEAM	All	X-Body	<u>X149-HR465S-57L</u>
5	68	RetroBright LED Forward Facing Headlight Kit - Classic White 3000K 5x7 - LOW-HIGH BEAM	All	X-Body	<u>X149-HR558S-30</u>
6	68-69	RetroBright LED Forward Facing Headlight Kit - Bright White 5700K 5x7 - LOW-HIGH BEAM	All	X-Body	<u>X149-HR558S-57</u>
7	68-69	RetroBright LED Forward Facing Headlight Kit - Bright White 5700K 5 3/4 Round - HIGH-BEAM ONLY	All	X-Body	<u>X149-HR575S-57H</u>
8	68-69	RetroBright LED Forward Facing Headlight Kit - Classic White 3000K 5 3/4 Round - HIGH-BEAM ONLY	All	X-Body	<u>X149-HR575R-30H</u>
9	68-69	RetroBright LED Forward Facing Headlight Kit - Classic White 3000K 5 3/4 Round - LOW-HIGH BEAM	All	X-Body	<u>X149-HR575R-30L</u>
10	68-69	RetroBright LED Forward Facing Headlight Kit - Bright White 5700K 5 3/4 Round - LOW-HIGH BEAM	All	X-Body	<u>X149-HR575R-57L</u>
11	70-79	RetroBright LED Forward Facing Headlight Kit - Classic White 3000K 7 Round - LOW-HIGH BEAM	All	X-Body	<u>X149-HR700R-30</u>
12	70-79	RetroBright LED Forward Facing Headlight Kit - Bright White 5700K 7 Round - LOW-HIGH BEAM	All	X-Body	<u>X149-HR700R-57</u>



VISIT US ONLINE FOR THE MOST UP-TO-DATE PRICING AND SELECTION



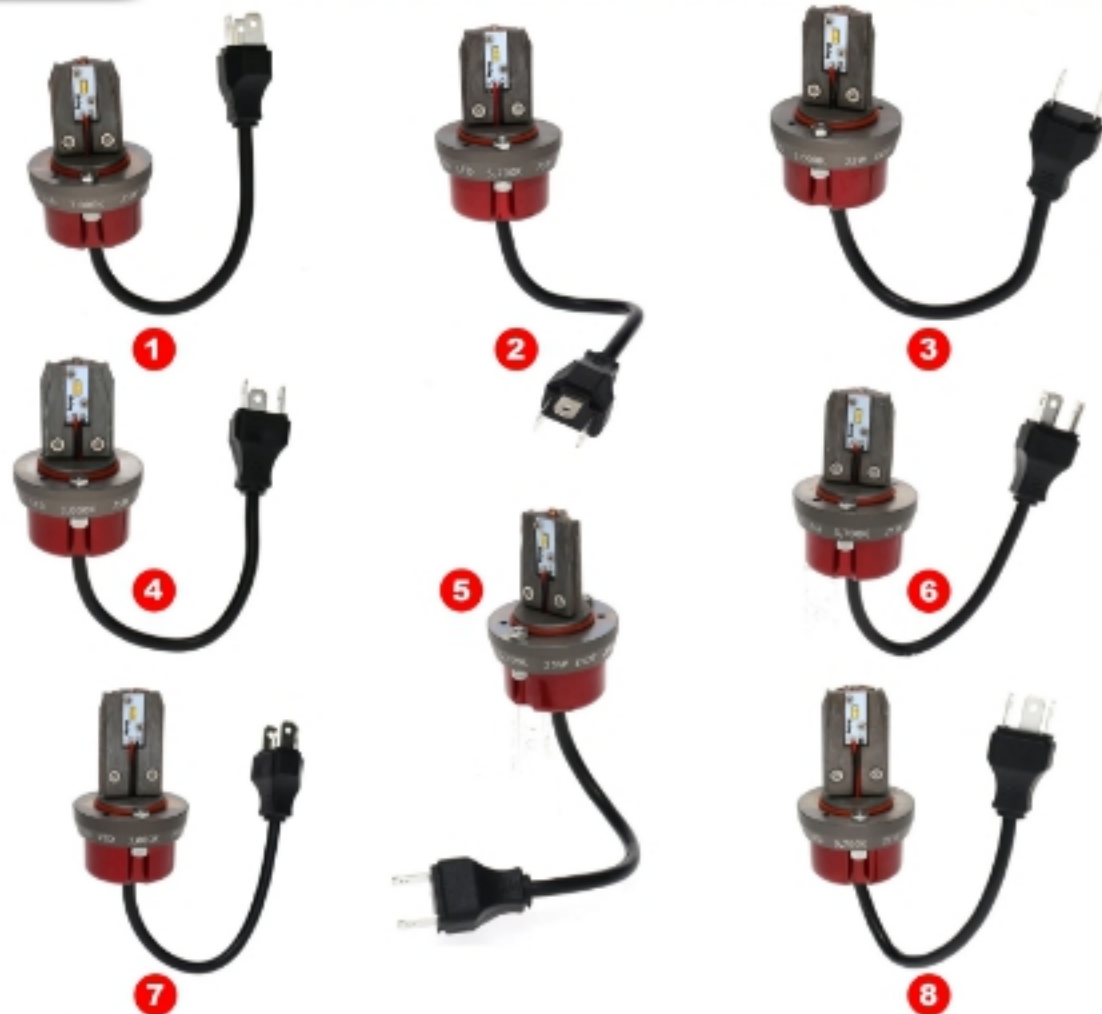

RT	YEAR	DESCRIPTION	GM	MODEL	PART #
1	68	RetroBright LED Forward Facing Light Bulb - Replacement Bulb - Classic White 3000K 5 3/4 or 4x6 - Standard H4 Wiring - High Beam - 3 Pin	All	X-Body	<u>X149-HR575R-30HB</u>
2	68-69	RetroBright LED Forward Facing Light Bulb - Replacement Bulb - Classic White 3000K 5 3/4 - Standard H4 Wiring - High and Low Beam - 3 Pin	All	X-Body	<u>X149-HR575R-30LB</u>
3	68-69	RetroBright LED Forward Facing Light Bulb - Replacement Bulb - Bright White 5700K 5 3/4 or 4x6 - Standard H4 Wiring - High Beam - 3 Pin	All	X-Body	<u>X149-HR575R-57HB</u>
4	68-69	RetroBright LED Forward Facing Light Bulb - Replacement Bulb - Bright White 5700K 5 3/4 - Standard H4 Wiring - High and Low Beam - 3 Pin	All	X-Body	<u>X149-HR575R-57LB</u>
5	68-69	RetroBright LED Forward Facing Light Bulb - Replacement Bulb - Classic White 3000K 7 or 5x7 - Standard H4 Wiring - High and Low Beam - 3 Pin	All	X-Body	<u>X149-HR700R-30B</u>
6	70-74	RetroBright LED Forward Facing Light Bulb - Replacement Bulb - Classic White 3000K 4x6 - Standard H4 Wiring - High and Low Beam - 3 Pin	All	X-Body	<u>X149-HR465S-30B</u>
7	70-74	RetroBright LED Forward Facing Light Bulb - Replacement Bulb - Bright White 5700K 4x6 - Standard H4 Wiring - High and Low Beam - 3 Pin	All	X-Body	<u>X149-HR465S-57B</u>
8	70-79	RetroBright LED Forward Facing Light Bulb - Replacement Bulb - Bright White 5700K 7 or 5x7 - Standard H4 Wiring - High and Low Beam - 3 Pin	All	X-Body	<u>X149-HR700R-57B</u>



VISIT US ONLINE FOR THE MOST UP-TO-DATE PRICING AND SELECTION



Officially Licensed GM Parts



WARNING: Cancer and Reproductive Harm - www.P65Warnings.ca.gov

WWW.AUTOMETALDIRECT.COM

833.404.4445

257

PARK LAMP

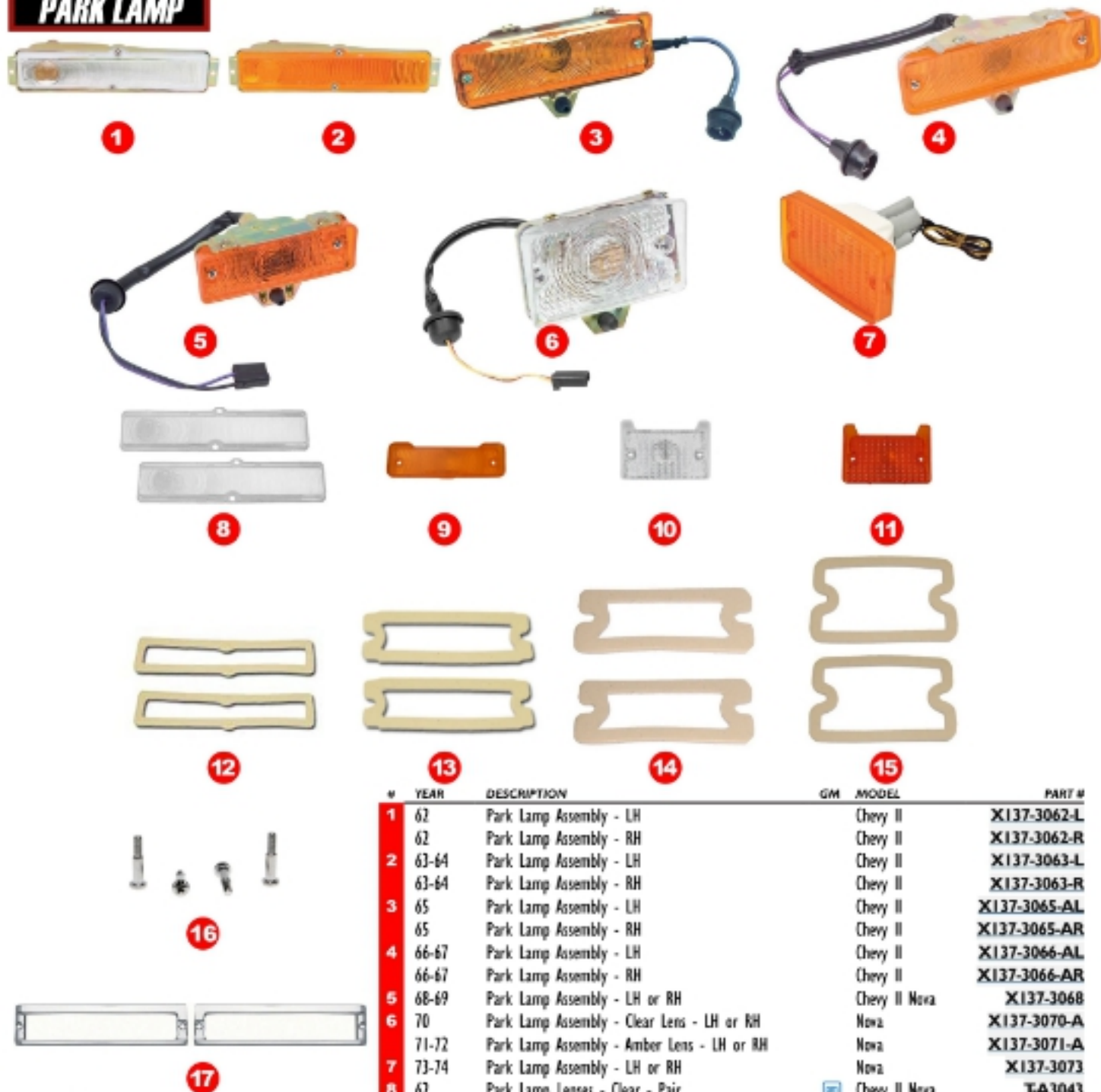

16



17



VISIT US ONLINE FOR THE MOST UP-TO-DATE PRICING AND SELECTION



#	YEAR	DESCRIPTION	GM	MODEL	PART #
1	62	Park Lamp Assembly - LH	Chevy II		X137-3062-L
	62	Park Lamp Assembly - RH	Chevy II		X137-3062-R
2	63-64	Park Lamp Assembly - LH	Chevy II		X137-3063-L
	63-64	Park Lamp Assembly - RH	Chevy II		X137-3063-R
3	65	Park Lamp Assembly - LH	Chevy II		X137-3065-AL
	65	Park Lamp Assembly - RH	Chevy II		X137-3065-AR
4	66-67	Park Lamp Assembly - LH	Chevy II		X137-3066-AL
	66-67	Park Lamp Assembly - RH	Chevy II		X137-3066-AR
5	68-69	Park Lamp Assembly - LH or RH	Chevy II	Nova	X137-3068
6	70	Park Lamp Assembly - Clear Lens - LH or RH	Nova		X137-3070-A
	71-72	Park Lamp Assembly - Amber Lens - LH or RH	Nova		X137-3071-A
7	73-74	Park Lamp Assembly - LH or RH	Nova		X137-3073
8	62	Park Lamp Lenses - Clear - Pair	Chevy II	Nova	TA3043
9	66-67	Park Lamp Lenses - Amber - Pair	Chevy II	Nova	TA3046
10	70	Park Lamp Lenses - Clear - Pair	Nova		TA3060
11	71-72	Park Lamp Lenses - Amber - Pair	Nova		TA3061
12	62-64	Park Lamp Lens Gaskets - Pair	Chevy II	Nova	J-4150
13	65-67	Park Lamp Lens Gaskets - Pair	Chevy II	Nova	J-4151
14	68-69	Park Lamp Lens Gaskets - Pair	Chevy II	Nova	J-4157
15	70-72	Park Lamp Lens Gaskets - Pair	Nova		J-4160
16	62-65	Park Lamp Lens Screws - 4pcs	Chevy II	Nova	W-226
	66-69	Park Lamp Lens Screws - 4pcs	Chevy II	Nova	X135-3066-S
	70-72	Park Lamp Lens Screws - 4pcs	Nova		X135-3467-S
17	62-64	Park Lamp Bezels - Pair	Chevy II	Nova	K-K116

SIDE MARKER

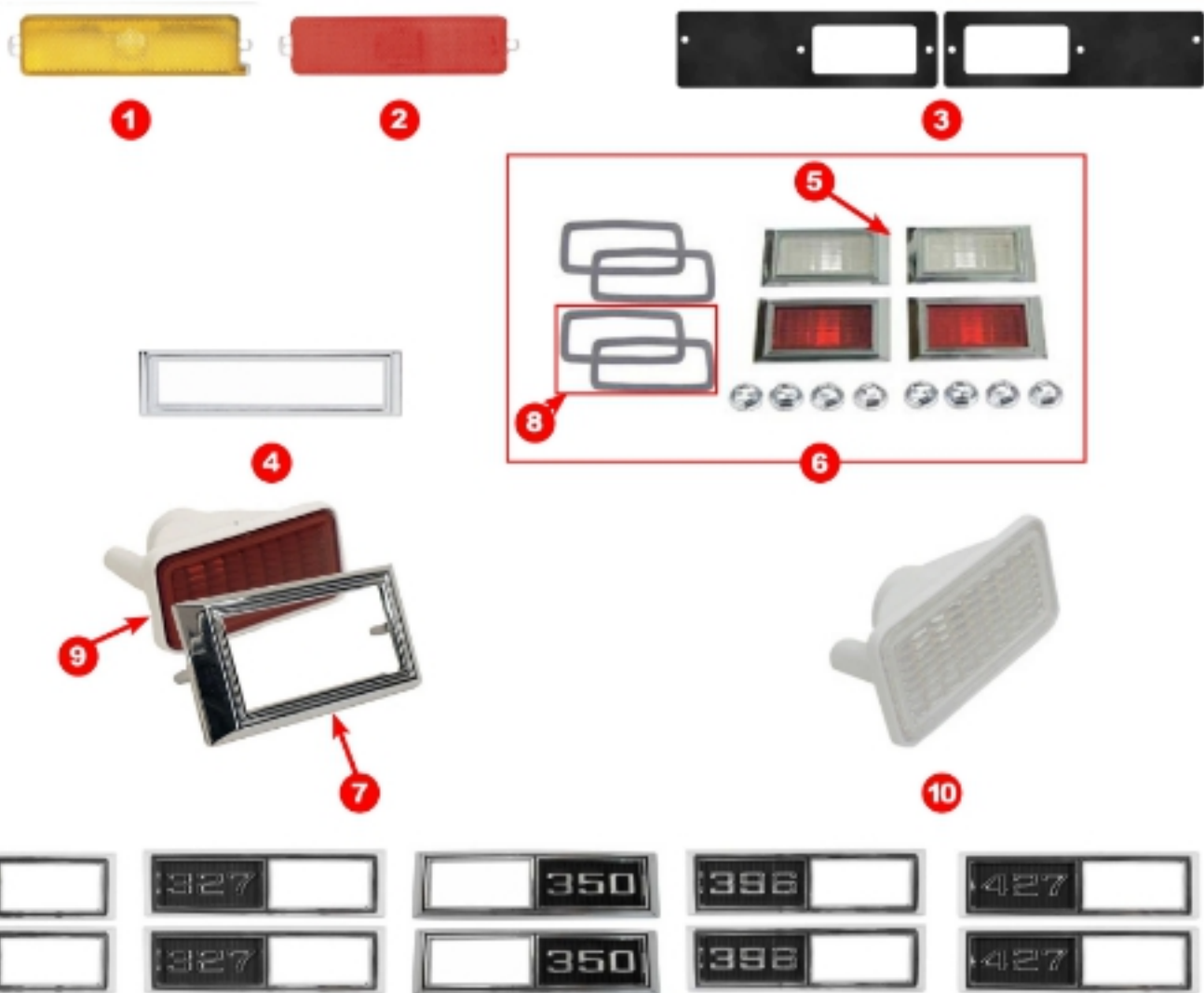

#	YEAR	DESCRIPTION	GM	MODEL	PART #
1	70-74	Side Marker Lamp Assembly - front - Amber - Pair		Nova	K-911283
2	70-74	Side Marker Lamp Assembly - Rear - Lens & Housing - Pair		Nova	K-917441
3	68-69	Side Marker Lamp Gaskets - Front - w/ Engine Designation Bezels - Pair		Nova	X241-3068-1P
4	70-74	Side Marker Lamp Bezel - Front - LH or RH	92	Nova	K-3962933
4	70-74	Side Marker Lamp Bezel - Rear - LH or RH	92	Nova	K-3962934
5	68	Side Marker Lenses & Bezels - Front & Rear - Bpcs		Chevy II Nova	W-948
6	68	Side Marker Lenses & Bezels - Front & Rear - w/ Gaskets & Hardware - 20pcs		Chevy II Nova	W-948A
7	68-69	Side Marker Lens Bezel - Rear - LH or RH		Chevy II Nova	W-795
8	68-69	Side Marker Lens Gaskets - 2pcs		Chevy II Nova	W-947
9	68-69	Side Marker Lens - Red - Rear	92	Chevy II Nova	W-945
10	68	Side Marker Lens - Clear - Front - LH or RH	92	Chevy II Nova	W-946
11	68-69	Side Marker Bezels - Front - "307" - Pair	92	Chevy II Nova	T-4520
12	68-69	Side Marker Bezels - Front - "327" - Pair	92	Chevy II Nova	T-4521
13	68-69	Side Marker Bezels - Front - "350" - Pair	92	Chevy II Nova	T-4522
14	68-69	Side Marker Bezels - Front - "396" - Pair	92	Chevy II Nova	T-4523
15	68-69	Side Marker Bezels - Front - "427" - Pair	92	Chevy II Nova	T-4524
	70-79	Side Marker Gaskets - Front & Rear - 4pcs		Nova, Ventura	J-4161



VISIT US ONLINE FOR THE MOST UP-TO-DATE PRICING AND SELECTION



Officially Licensed GM Parts



WARNING: Cancer and Reproductive Harm - www.P65Warnings.ca.gov

WWW.AUTOMETALDIRECT.COM

833.404.4445

259

TAIL LAMP



#	YEAR	DESCRIPTION	GM	MODEL	PART #
1	62-64	Tail Lamp Assembly - LH or RH	☑	Nova	K-899439
2	66-67	Tail Lamp Assembly - LH or RH	☑	Nova	T-3058
	66-67	Tail Lamp Assembly - LH or RH	☑	Chevy II Nova	X950-3066
	68-69	Tail Lamp Assembly - LH	☑	Chevy II Nova	X950-3068-L
	68-69	Tail Lamp Assembly - RH	☑	Chevy II Nova	X950-3068-R
3	70-71	Tail Lamp Assembly - LH	☑	Nova	K-5964171
	70-71	Tail Lamp Assembly - RH	☑	Nova	K-5964172
4	71-72	Tail Lamp Assembly - LH		Nova	K-A26026
	71-72	Tail Lamp Assembly - RH		Nova	K-A26025
5	66-67	Tail Lamp Bezel Seals - Pair		Chevy II Nova	J-4156
	68-69	Tail Lamp Bezel Seals - Pair		Chevy II Nova	J-41581
	70-72	Tail Lamp Bezel Seals - Pair	☑	Nova	J-41592
6	73-74	Tail Lamp to Body Gaskets - Pair		Nova	K-5950233
7	62-64	Tail Lamp Lens - Pair		Chevy II Nova	TA3038
8	62-64	Tail Lamp Lens - 26 Red LED - LH or RH		Chevy II	X951-3062-D
	62-64	Tail Lamp Lens - 26 Red Sequential LED - LH or RH		Chevy II	X951-3062-E
9	65	Tail Lamp Lens - Pair	☑	Chevy II Nova	TA3050
10	66-67	Tail Lamp Lens - LH or RH	☑	Chevy II Nova	K-5957440
	66-67	Tail Lamp Lens - 30 Red LED - LH or RH	☑	Chevy II	X951-3066-D
11	68-69	Tail Lamp Lens - Pair	☑	Chevy II Nova	TA3053
	68-69	Tail Lamp Lens - 36 Red LED - LH or RH	☑	Chevy II	X951-3068-D
12	70-71	Tail Lamp Lens - LH		Nova	K-N5503
	70-71	Tail Lamp Lens - RH		Nova	K-N5504
13	71-72	Tail Lamp Lens - LH	☑	Nova	K-5964513
	71-72	Tail Lamp Lens - RH	☑	Nova	K-5964514
14	73-74	Tail Lamp Lens - LH	☑	Nova	K-5965743
	73-74	Tail Lamp Lens - RH	☑	Nova	K-5965744
15	65	Tail Lamp Lens Gaskets - Pair	☑	Chevy II Nova	TA3050G
16	66-67	Tail Lamp Lens Gaskets - Pair	☑	Chevy II Nova	TA3047G
17	70-71	Tail Lamp Lens Gasket - LH or RH	☑	Nova	TA3057G
18	71-72	Tail Lamp Lens Gasket - LH or RH	☑	Nova	TA3063G
19	73-74	Tail Lamp Housing - LH	☑	Nova	X949-3073-L
	73-74	Tail Lamp Housing - RH	☑	Nova	X949-3073-R
20	62-64	Tail Lamp Housing Body Seals - Pair	☑	Nova	X949-3062-IP

VISIT US ONLINE FOR THE MOST UP-TO-DATE PRICING AND SELECTION



BACK-UP LAMP



1



2



3



4



5

#	YEAR	DESCRIPTION	GM	MODEL	PART #
1	62-64	Back-up Lamp Lens - 32 LED - LH or RH	<input type="checkbox"/>	Chevy II Nova	X955-3062-D
2	65	Back-up Lamp Lens - Pair	<input type="checkbox"/>	Chevy II Nova	TA3051
3	66-67	Back-up Lamp Lens - 24 LED - LH or RH	<input type="checkbox"/>	Chevy II Nova	X955-3066-D
4	66-67	Back-up Lamp Lens - LH or RH	<input type="checkbox"/>	Chevy II Nova	K-5957441
5	68-69	Back-up Lamp Lens - Pair	<input type="checkbox"/>	Chevy II Nova	K-K1044



6

#	YEAR	DESCRIPTION	GM	MODEL	PART #
6	62-79	LED Flasher Assembly - 12V w/ Reverse Polarity Base	All	X-Body	X495-1000-12VD

WEATHERSTRIP



7

#	YEAR	DESCRIPTION	GM	MODEL	PART #
62-63	62-63	Weatherstrip Set - 2DR Sedan	Chevy II	Nova	X599-3062-1S
62-63	62-63	Weatherstrip Set -2DR Hardtop	Chevy II	Nova	X599-3062-S
64	64	Weatherstrip Set - 2DR Sedan	Chevy II	Nova	X599-3064-1S
64	64	Weatherstrip Set - 2DR Hardtop	Chevy II	Nova	X599-3064-S
65	65	Weatherstrip Set - 2DR Sedan	Chevy II	Nova	X599-3065-1S
65	65	Weatherstrip Set - 2DR Hardtop	Chevy II	Nova	X599-3065-S
66	66	Weatherstrip Set - 2DR Sedan	Chevy II	Nova	X599-3066-1S
66	66	Weatherstrip Set - 2DR Hardtop	Chevy II	Nova	X599-3066-S
67	67	Weatherstrip Set - 2DR Hardtop	Chevy II	Nova	X599-3067-S
67	67	Weatherstrip Set - 2DR Sedan	Chevy II	Nova	X599-3067-1S
68	68	Weatherstrip Set - 2DR Coupe	Chevy II	Nova	X599-3068-S
69	69	Weatherstrip Set - 2DR Coupe	Chevy II	Nova	X599-3069-S
70	70	Weatherstrip Set - 2DR Coupe	Chevy II	Nova	X599-3070-S
71-72	71-72	Weatherstrip Set - 2DR Coupe	Chevy II	Nova	X599-3071-S

BUMPERS & SEALS



8

9



#	YEAR	DESCRIPTION	GM	MODEL	PART #
62-65	62-65	Rubber Bumper Set	Chevy II	Nova	J-4091
66-67	66-67	Rubber Bumper Set	Chevy II	Nova	J-4093
68-74	68-74	Rubber Bumper Set	All	X-Body	J-4094
62-65	62-65	Rear Body to Bumper Seal	Chevy II	Nova	J-4060
68-72	68-72	Rear Body to Bumper Seal	Chevy II	Nova	J-40601

PAINT GASKET

VISIT US ONLINE FOR THE MOST UP-TO-DATE PRICING AND SELECTION



10

#	YEAR	DESCRIPTION	GM	MODEL	PART #
62-63	62-63	Paint Gasket Set	Chevy II	Nova	R-N124
64	64	Paint Gasket Set	Chevy II	Nova	R-N125
65	65	Paint Gasket Set	Chevy II	Nova	R-N126
66-67	66-67	Paint Gasket Set	Chevy II	Nova	R-N127
68-69	68-69	Paint Gasket Set	Chevy II	Nova	R-N128
70	70	Paint Gasket Set	Nova		R-N129
71-72	71-72	Paint Gasket Set	Nova		R-N130

SUSPENSION & STEERING



#	YEAR	DESCRIPTION	GM	MODEL	PART #
1	62-67	Control Arm Bumper- Lower - OE Style	VE	Chevy II Nova	SS-18
2	68-72	Control Arm Bumper - Lower	VE	Chevy II Nova	SS-70
3	68-74	Control Arm Bumper - Upper	VE	Chevy II Nova	SS-69
4	68	Control Arm Dust Shield Set - w/ Hardware		Chevy II Nova	R-N106
	69	Control Arm Dust Shield Set - w/ Hardware		Nova	R-N107
	70-72	Control Arm Dust Shield Set - w/ Hardware		Nova	R-N108
	68-72	Control Arm Bushings - Upper - Pair	VE	Chevy II Nova	SS-234
	68-72	Control Arm Bushing - Upper		Chevy II Nova	SS-234A
5	68-74	Control Arm Bushing Set - Upper - 4pcs	VE	Chevy II Nova	SS-8
6	68-74	Control Arm Bushing Set - Front & Rear Lower - 4pcs	VE	Chevy II Nova	SS-9
	68-74	Control Arm Bushing - Lower front	VE	Chevy II Nova	SS-237
	68-74	Control Arm Bushing - Lower Rear front	VE	Chevy II Nova	SS-258
	68-74	Control Arm Bolt - Lower		Chevy II Nova	W-547
7	68-74	Control Arm Bolts - Lower - 4pcs		Chevy II Nova	W-547A
8	68-74	Idler Arm Assembly	VE	Chevy II Nova, Ventura	SS-71B
9	68-74	Tie Rod - Outer	VE	Chevy II Nova, Ventura	SS-381
10	68-74	Tie Rod End - Inner	VE	Chevy II Nova	SS-681
11	68-74	Tie Rod Sleeve - w/ Clamps & Hardware	VE	Chevy II Nova	SS-350
12	68-74	Ball Joint - Lower - OE Style	VE	Chevy II Nova	SS-197
13	68-74	Ball Joint - Upper - OE Style	VE	Chevy II Nova, Ventura	SS-195
14	63-69	Sway Bar Bushings - 11/16" Standard - 2pcs	VE	Chevy II Nova	SS-22
15	68-78	Sway Bar End Link Set	VE	Chevy II Nova	SS-39
16	62-69	Shackle Bushing Set - Rear - OE Style	VE	Chevy II Nova	SS-5

VISIT US ONLINE FOR THE MOST UP-TO-DATE PRICING AND SELECTION



BEARINGS & SHIELDS



#	YEAR	DESCRIPTION	GM	MODEL	PART #
1	64-72	Front Wheel Bearing Caps - 2pcs		Chevy II Nova	W-087
	64-72	Front Wheel Bearing Cap		Chevy II Nova	W-087A
	68	Disc Brake Backing Plates - Pair		Chevy II Nova	W-416
2	69-72	Disc Brake Backing Plates - Pair	☐	Nova	W-383A

TRANSMISSION CROSSMEMBER



#	YEAR	DESCRIPTION	GM	MODEL	PART #
1	68-70	Transmission Crossmember - TH-400		Chevy II Nova	W-954
2	68-72	Transmission Crossmember - Big Block, 4-Speed M/T		Chevy II Nova	W-950
3	68-74	Transmission Crossmember - Except TH-400 & Big Block, 4-Speed		Chevy II Nova	W-952

SUBFRAME CONNECTOR

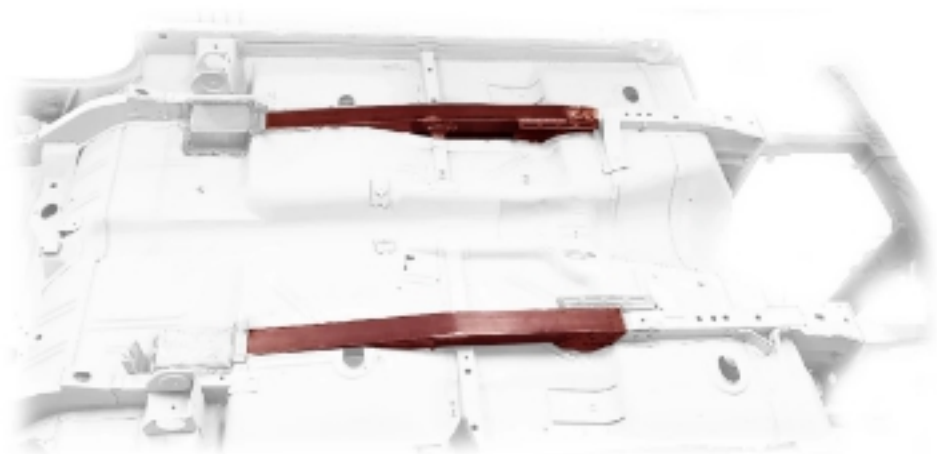

#	YEAR	DESCRIPTION	GM	MODEL	PART #
1	62-67	Weld-in Frame Connectors		Chevy II Nova	X896-3062-S



VISIT US ONLINE FOR THE MOST UP-TO-DATE PRICING AND SELECTION



Officially Licensed GM Parts



WARNING: Cancer and Reproductive Harm - www.P65Warnings.ca.gov

WWW.AUTOMETALDIRECT.COM

833.404.4445

263

CELEBRATING our 4th DECADE of EXCELLENCE



Phoenix has conversion kits to make it easy to install an overdrive into your Classic GM truck.

Let our trained staff help you select the proper transmission and components to give you the very best performance and economy possible with your vehicle. We have overdrive options to fit nearly any combination from early model up through the latest designs.

We also carry the incredible "Compushift" electronic transmission control system as well as our own easy to use TV cable and bracket systems.



The highest quality trans packages matched with unbeatable customer service since 1983!

Phoenix Transmission Products has specialized in building specialty transmissions and torque converters for the automotive enthusiast. We build each transmission and converter per order to match these components to your vehicle and driving style. Our friendly tech people are always glad to talk with you, hear about your project, and love to answer your questions. No bad attitudes here. We are performance car nuts just like you!

We have automatic transmissions, torque converters and installation accessories to fit nearly any application.

Give us a call or email to:
questions@phoenixtrans.com.
We are happy to help.

PHOENIX
TRANSMISSION PRODUCTS
Order Toll Free 1-866-SHIFT UP
Tech 817-599-7680 • Order Toll Free 866-744-3887



Check us out at:
www.phoenixtrans.com

SUBFRAME



 VISIT US ONLINE FOR THE MOST
 UP-TO-DATE PRICING AND SELECTION



#	YEAR	DESCRIPTION	GM	MODEL	PART #
1	68	Subframe Assembly		Chevy II Nova	390-3568
2	69-72	Subframe Assembly		Nova, Ventura II	390-3569
3	68	Subframe Body Mount Set - 12pcs		Chevy II Nova	K-K3025
4	68-72	Subframe Body Mount Set		Chevy II Nova	W-942
	68-72	Subframe Mount Body Cushion		Chevy II Nova, Ventura	W-196
5	67-81	Subframe Mount Body Cushions - 4pcs		Chevy II Nova, Ventura	W-196A
6	68-74	Subframe Mount Repair Plate Set - 6pcs		Chevy II Nova	W-646
	68-72	Subframe & Radiator Support Bushing Set - 12pcs		Chevy II Nova	SS-4
7	68-72	Subframe Support Bushing Set - OE Style & Quality - 8pcs		Chevy II Nova	SS-4A
8	68-74	Subframe Mounting Hole Repair - 4pcs		Chevy II Nova	W-696

FRAME RAIL



VISIT US ONLINE FOR THE MOST UP-TO-DATE PRICING AND SELECTION



#	YEAR	DESCRIPTION	GM	MODEL	PART #
1	68-72	Rear Frame Rail - LH		Chevy II Nova, Ventura II	895-3068-L
2	68-72	Rear Frame Rail - RH		Chevy II Nova, Ventura II	895-3068-R
3	68-72	Rear Frame Cross Rail - Behind Rear Bumper		Chevy II Nova, Ventura II	870-3068
4	68-72	Rear Frame Cross Rail - Mounts Under Rear End of Trunk Floor		Chevy II Nova, Ventura II	870-3068-I
5	68-72	Rear Cross Rail Filler - LH		Chevy II Nova, Ventura II	871-3068-L
	68-72	Rear Cross Rail Filler - RH		Chevy II Nova, Ventura II	871-3068-R
6	68-74	Rear Leaf Spring Front Bushing		Nova, Ventura II	SS-6
7	62-69	Rear Leaf Spring Shackle Assembly - OE Quality - LH or RH		Chevy II Nova	W-270
8	70-79	Rear Leaf Spring Shackle Set - w/ Bushings and Hardware - LH or RH		Nova, Ventura II	X865-3570-25
9	68-71	Rear End Cover - 12-Bolt		Chevy II Nova	W-577

FENDER MOLDING



#	YEAR	DESCRIPTION	GM	MODEL	PART #
1	68-72	Fender Eyebrow Moldings - Pair		Chevy II Nova	K-K499

HOOD MOLDING

#	YEAR	DESCRIPTION	GM	MODEL	PART #
2	68-72	Hood Lip Molding	GM	Chevy II Nova	K-3927930

DASH TRIM



#	YEAR	DESCRIPTION	GM	MODEL	PART #
3	65	Dash Trim Set - Spcs w/ "Nova SS" Script	12	Chevy II Nova	T-3052
	65	Dash Trim Set - Spcs w/ "Nova" Script	10	Chevy II Nova	T-3053

ROOF MOLDING

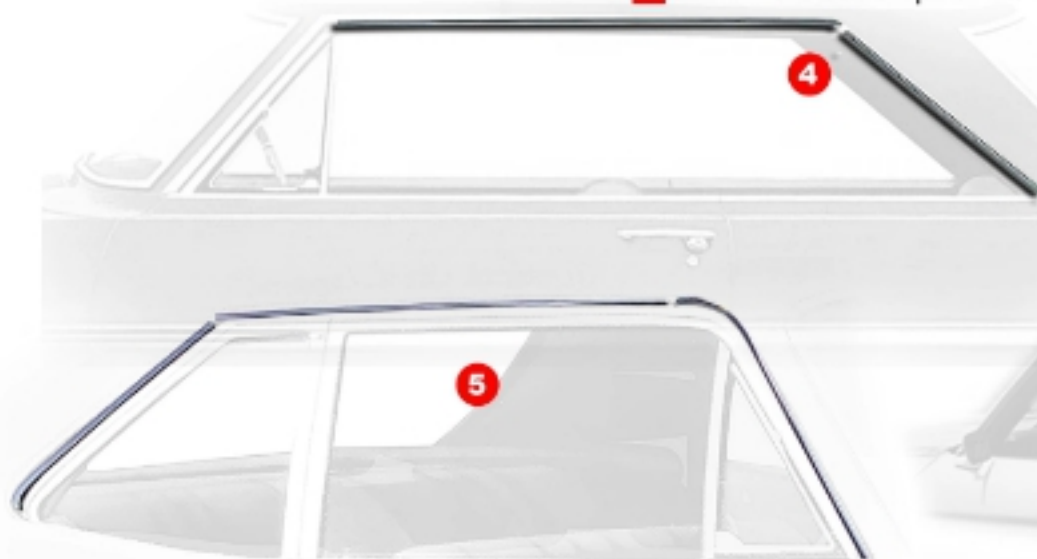

#	YEAR	DESCRIPTION	GM	MODEL	PART #
4	62-65	Drip Rail Molding Set - Hardtop - 4pcs		Chevy II Nova	X630-3062-2S
5	68-72	Roof Drip Molding Set - 2DR Sedan (Post) - 6pcs		Chevy II Nova	K-R1629
6	68-74	Vinyl Top Molding Set		Chevy II Nova	K-14389



VISIT US ONLINE FOR THE MOST UP-TO-DATE PRICING AND SELECTION



#	YEAR	DESCRIPTION	GM	MODEL	PART #
	65	Body Molding Trim Template - (non-SS)		Chevy II Nova	W-1229
	66	Fender Molding Template		Chevy II Nova	W-1233
	65	Trunk Lid Trim Template		Chevy II Nova	W-1234
	67	Trunk Trim Template Set - Hardtop		Chevy II Nova	W-1240



Officially Licensed GM Parts



WARNING: Cancer and Reproductive Harm - www.P65Warnings.ca.gov

WWW.AUTOMETALDIRECT.COM

833.404.4445

267

EMBLEMS



1



2



3



4



5



6



7



8



9



10



11



12



13



14



15



16



17



18



19



20



21



22



23



24

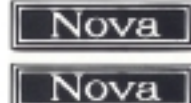

25



26



VISIT US ONLINE FOR THE MOST UP-TO-DATE PRICING AND SELECTION



#	YEAR	DESCRIPTION	GM	MODEL	PART #
1	64	Fender Emblem - 283 "V" - LH or RH	☑	Chery II Nova	T-2161
2	65	Fender Emblem - "283" - LH or RH	☑	Chery II Nova	K-3865833
3	65-67	Fender Emblem - "350" - LH or RH	☑	Chery II Nova	K-3905718
4	65-67	Fender Emblem - "327" - LH or RH	☑	Chery II Nova	W-263
5	65-67	Fender Emblem - "V-Flag" - LH or RH	☑	Chery II Nova	W-419
6	69-70	Fender Emblem - "Yenko" - LH or RH	☑	Nova	K-K80013
7	69-72	Fender Emblem - "Nova"	☑	Nova	K-3953676
8	69-74	Fender Emblems - "307" - Pair	☑	Nova	W-410
	69-74	Fender Emblem - "307" - LH or RH		Nova	W-410A
9	70-74	Fender Emblem - "350" - LH or RH	☑	Nova Ventura	K-3970546
10	70-74	Fender Emblem - "427" - LH or RH	☑	Nova	K-C119
11	73-74	Fender Emblem - "Nova" - LH or RH	☑	Nova	K-6258150
12	69	Fender & Hood Emblem - "427" with Bar (stud mounted)	☑	Nova	K-K678
13	63-64	Fender & Quarter Panel Emblems - Pair		Chery II Nova	T-3022
	64	Fender Panel Emblem - "Nova SS"		Chery II Nova	K-3832828
14	62	Fender Shields - Red "6" - 6 Cylinder - Pair		Chery II Nova	T-3018
15	63	Fender Shields - Black "6" - 6 Cylinder - Pair		Chery II Nova	T-3016
	62-65	Fender Emblem Template Sec - For "283 Flag" Emblem		Chery II Nova	W-1228
	64	Fender Emblem Template Sec - For "V" Emblem		Chery II Nova	W-1224
	64	Fender Emblem Template Sec - For "Nova SS" Emblem - Super Sport		Chery II Nova	W-1226
	66-67	Fender Emblem Template Sec - For "V8 Flag" Emblem		Chery II Nova	W-1237
16	66	Grille Emblem - "CHEVY II"	☑	Chery II Nova	K-3874540
17	66	Grille Emblem - "SS"	☑	Chery II Nova	T-3042
18	67	Grille Emblem - "SS"	☑	Chery II Nova	T-3050
19	67	Grille Emblem - "CHEVY II"	☑	Nova	T-3051
20	68-69	Grille Emblem - "SS" - Super Sport	☑	Chery II Nova	W-867
21	70-72	Grille Emblem - "SS"	☑	Nova	K-3940538
22	73-74	Grille Emblem - "SS" - Super Sport	☑	Nova	K-6258813
23	74	Grille Emblem - Bowtie	☑	Nova	K-6260838
24	66-67	Door Panel Emblem - "Chevy II" - Pair	☑	Chery II Nova	K-4539568
25	69-72	Door Panel Emblems - "Nova" - Pair	☑	Nova	K-7790751
26	67	Door Decal - Aqua Foil "GM Mark Of Excellence"	☑	Chery II Nova	W-856
	68-70	Door Decal - Blue Foil "GM Mark Of Excellence"	☑	Chery II Nova	W-857

EMBLEMS



1



2



3



4



5



6



7



8



9

11



10

12



13



14



15



16

#	YEAR	DESCRIPTION	GM	MODEL	PART #
1	67	Dash Emblem - Lower - "Nova Chevy II"		Chevy II Nova	T3045
2	69	Horn Shroud Emblem - "SS" - w/ Hardware		Nova	W-148
3	69-72	Hood Edge Molding - w/ Bowtie Logo		Nova	T3085
4	62	Quarter Panel Emblems - "Nova Chevy II 400" - Pair		Chevy II Nova	T3015
5	63	Quarter Panel Emblem - "Nova SS"		Chevy II Nova	K-4883156
6	65	Quarter Panel Emblems - "Nova SS" - Pair		Chevy II Nova	T3031
6	65	Quarter Panel Emblems - "Nova Chevy II" - Pair		Chevy II Nova	T3030
7	66-67	Quarter Panel Emblem - "Super Sport" - LH or RH - Super Sport		Chevy II Nova	K-4227012
8	66-67	Quarter Panel Emblems - "Nova Chevy II" - Pair		Chevy II Nova	T3040
	65	Quarter Panel Emblem Template Sec - For "Nova SS" Emblem - Super Sport		Chevy II Nova	W-1231
	66-67	Quarter Panel Emblem Template Sec - For "Nova" Emblem		Chevy II Nova	W-1235
	66-67	Quarter Panel Emblem Template Sec - For "Nova SS" Emblem - Super Sport		Chevy II Nova	W-1236
9	65	Rear Body Emblem - w/ Blue Bowtie Logo		Chevy II Nova	T3029
10	68-69	Rear Body Emblem - "SS" - Super Sport		Chevy II Nova	T3075
	70-72	Rear Body Emblem - "SS" - Super Sport		Nova	T3090
11	70-72	Rear Body Panel Molding - "SS" - Super Sport		Nova	T3091
12	70-72	Rear Body Panel Molding - Plain - Non-SS		Nova	T3092
13	63-64	Trunk Emblem - "Nova SS"		Chevy II Nova	T3020
14	65	Trunk Emblem - "Nova SS"		Chevy II Nova	T3032
15	68	Trunk Emblem - "CHEVY II BY CHEVROLET"		Chevy II Nova	T3070
16	68-72	Trunk Emblem - "Nova BY CHEVROLET"		Chevy II Nova	K-8728940
	70	Trunk Emblem Template - For "Nova" Emblem		Nova	W-1241



VISIT US ONLINE FOR THE MOST UP-TO-DATE PRICING AND SELECTION





X-BODY

HATS

This Auto Metal Direct hat is the original Flexfit cap with poly-weave spandex to assure you get the perfect fit.



#	DESCRIPTION	PART #
1	AMD Black Flexfit Cap	AMDHAT2
2	AMD Black Snapback Cap	AMDHAT3

Classic AMD embroidered trucker cap built with the Richardson 112 quality and fit you've come to expect from premium headwear.

SHOP BANNER



Don't forget about our premium AMD vinyl logo sign banner. Made from 16oz vinyl, UV printing, and laminated, it's made to withstand the test of time. It comes complete with metal grommets at each corner for easy installation.
"Measures 4' X 3"

#	DESCRIPTION	PART #
1	AMD Logo Banner 4' x 3' with grommets	AMDBANNER4X3

APPAREL



VISIT US ONLINE FOR THE MOST UP-TO-DATE PRICING AND SELECTION



Show your GM Car pride with our high quality Chevelle and Camaro t-shirts. These are high quality Next Level shirts that runs small in size. They are super soft, comfortable, and an perfect every day use t-shirt!

Size = Small - 5XL
60% Cotton, 40% Polyester



Our popular GM Car shirt design is also available in a Hoodie! Featuring a beautiful Chevelle and a pro touring Camaro. Show off your Chevy truck pride and support for your favorite automotive restoration parts supplier - Auto Metal Direct!

* Pre-Shrunk fleece knit with a softer feel keeping you warm and cozy.

#	DESCRIPTION	PART #
	GM Car T-Shirt - Small - Navy	AMDGMCAR-S
	GM Car T-Shirt - Medium - Navy	AMDGMCAR-M
	GM Car T-Shirt - Large - Navy	AMDGMCAR-L
	GM Car T-Shirt - X-Large - Navy	AMDGMCAR-XL
	GM Car T-Shirt - 2X-Large - Navy	AMDGMCAR-2XL
	GM Car T-Shirt - 3X-Large - Navy	AMDGMCAR-3XL
	GM Car T-Shirt - 4X-Large - Navy	AMDGMCAR-4XL
	GM Car T-Shirt - 5X-Large - Navy	AMDGMCAR-5XL
	GM Car Hoodie - Small - Black	AMDGMCAR-HOOD-S
	GM Car Hoodie - Medium - Black	AMDGMCAR-HOOD-M
	GM Car Hoodie - Large - Black	AMDGMCAR-HOOD-L
	GM Car Hoodie - X-Large - Black	AMDGMCAR-HOOD-XL
	GM Car Hoodie - 2X-Large - Black	AMDGMCAR-HOOD-2XL
	GM Car Hoodie - 3X-Large - Black	AMDGMCAR-HOOD-3XL
	GM Car Hoodie - 4X-Large - Black	AMDGMCAR-HOOD-4XL
	GM Car Hoodie - 5X-Large - Black	AMDGMCAR-HOOD-5XL





ORDERING INFORMATION

Internet Orders

Shop our complete product offering anytime online at autometaldirect.com. Here you will find our most up-to-date product offerings, pricing, inventory and information. Join our community of customer rides or browse through our selection of installation videos.

Phone Orders

Feel free to call us toll-free at 833.404.4443 from anywhere in the U.S. or Canada. Our sales staff has a wealth of knowledge and first-hand experience and can assist you with any questions you may have. Our call center hours are 8:00 a.m. - 6:00 p.m. Monday - Friday, Eastern Standard. Our call center is closed on Saturday and Sunday and some U.S. Federal Holidays.

Customer Pick Up Orders

AMD offers a customer pick-up option at no additional fee. We encourage this option whenever possible to save you money on shipping your order. You can pick up your order from our retail store located at 3348 Gateway Centre Parkway, Gainesville, GA 30507. We HIGHLY recommend placing your order prior to arriving at our location to save you time. Feel free to call us toll-free at 833.404.4443 from anywhere in the U.S. or Canada. Our retail showroom hours are 8:00 a.m. - 5:00 p.m. Monday - Friday, Eastern Standard Time. Our retail showroom is closed on Saturday and Sunday and some U.S. Federal Holidays.

International Orders

For orders outside the United States or Canada, please utilize our website for international orders or call us by dialing the international access code then 1.770.967.0909.

PAYMENT METHODS

Credit / Debit Cards

We gladly accept Visa, Mastercard, Discover or American Express credit cards and Visa and Mastercard Debit Cards. We must be able to verify the shipping address on your card before shipment.

PayPal

We will accept Paypal for online orders that are shipped via FedEx Ground inside the continental U.S.

Check / Money Order / Other

We accept payments via money order, personal check, business check or cashier's check. We reserve the right to hold orders until payment clears. We cannot ship any order via C.O.D.

SHIPPING

Ground Shipments

AMD utilizes FedEx Ground for small parcel shipments. We do offer Express Ground (1, 2, or 3 day) for an additional fee. Please inform your salesperson or notate on your order if you would like to utilize a Express method. Delivery dates are expectations and are not guaranteed.

Oversize Box Shipments

Oversize package fees are assessed on a per piece basis depending on the shipping size of the product. Oversize fees are in addition to the flat rate ground shipping fee.

Truck Freight

Any item(s) too large to ship FedEx Ground will be shipped via truck freight. Please check autometaldirect.com for the most up-to-date shipping zones and freight charges under the Shipping & Returns tab at the top of the website.

Damages

ALL TRUCK FREIGHT SHIPMENTS MUST BE INSPECTED AT THE TIME OF DELIVERY! If you find any damages you must contact AMD as soon as possible. If your shipment contains damage, please note "DAMAGED" with the freight carrier at time of delivery and call us immediately at 866.591.8309. AMD will work with you and the freight carrier to find the best solution.

Additional Boxing Fees

Due to the fragile nature of glass, we have gone the extra mile in packaging orders that contain individual glass pieces and glass kits. The following charges will be added to full glass kits, windshields and some back glass orders. These fees are to cover the cost of the protective packaging and will be added to the actual shipping fee:

Windshield / Back Glass	add \$35.00
Complete Glass Sets	add \$60.00

Some other items require more attention when packaging to ensure that you receive them in the best condition possible. These items will incur an additional boxing or crate fee. These fees are to cover the cost of the protective packaging and will be added to the actual shipping fee:

Bed Floor Crate	add \$200.00
Hood Safety Box	add \$45.00



GUARANTEE

Parts Guarantee

All Auto Metal Direct brand products are guaranteed to be free from defects in material and workmanship. We require that you test fit ALL parts before sanding, priming, painting or modifying them in any way. If we deem your part defective, our responsibility is to replace the part, issue credit, or refund the original purchase price. We are not responsible for any paint or labor expenses. The credit or refund amount will not exceed the defective part's original purchase price and may be subjected to being issued as in-store credit.

BACK ORDERS

Back Orders

Any items not available at the time the order is placed will be put on backorder. All backordered items that ship after the original shipment will be subject to additional shipping charges. Backorders will not be shipped without your prior authorization. Please let us know if you do not wish to receive backorders.

RETURNS

Returns

You may return any unused, undamaged, unmodified, and resellable part in its original packaging for exchange, credit or refund for up to 6 months after original purchase date. All orders, cancellations and returns are subject to a 15% restocking fee. ALL RETURNS MUST HAVE PRIOR AUTHORIZATION BEFORE THEY WILL BE ACCEPTED. All shipping costs associated with a return are your responsibility. If the return shipment is damaged in transit back to us, it may not be accepted.

MORE PARTS ONLINE

Additional Parts Available

Although this catalog is geared towards the GM Car owner, we do carry a LOT of parts for other makes and models. If you're anything like us, you have several projects that consist of a large variety of vehicles saved from the scrap heap. Be sure to check out our full selection at autometaldirect.com

COPYRIGHT / TRADEMARK

Copyright and Trademark Information

For this catalog, All rights are reserved. No part of this catalog is to be reproduced, copied, or retransmitted in any form or means without direct written consent from Auto Metal Direct. AMD Auto Metal Direct, 'Our Name Says it All' 'More than Metal, and 'Never Too Far Gone' are registered trademarks of Auto Metal Direct.

© Copyright 2025 Auto Metal Direct, LLC.

COPYRIGHT / TRADEMARK

Continued

Any part indicated GM Restoration Part are officially manufactured and licensed under the GM Restoration License Program. Logos, illustrations, images and trademarks of General Motors are used under license by AMD and our suppliers. Any descriptions bearing trade-marked names are for application reference only.

gm restoration

Any part indicated GM Restoration Part are officially manufactured and licensed under the GM Restoration License Program. Logos, illustrations, images and trademarks of General Motors are used under license by AMD and our suppliers. Any descriptions bearing trade-marked names are for application reference only.



AMD Garage is our show series dedicated to bringing you the best of the best. We offer the latest content from industry leaders, top builders, diy car enthusiast, car and truck shows, social media influencers, and so much more. Follow us at @autometaldirect on all major social media outlets.

COVER CREDITS

Front Cover

Photography by: John Jackson
@notstockphoto





POWER BRAKES



BLACKOUT

DISC BRAKES



ALUMINUM FUEL TANKS

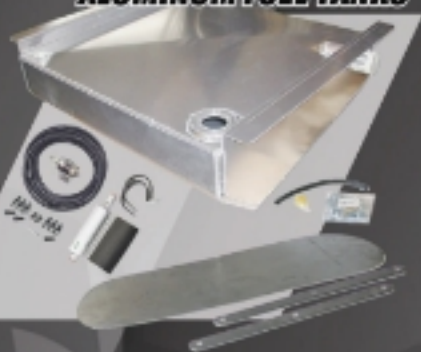

TUBULAR CONTROL ARM KITS



4-LINK SUSPENSION KIT



COILOVERS



1967-69 Chevy Camaro and Pontiac Firebird 4-Link Suspension Kit

HOLLOW SWAY BARS



STEERING



OUR WEEK TO WICKED 69 CAMARO



800.638.1703

1550 MELISSA CT. CORONA, CA 92879

performanceonline.com

Follow us:

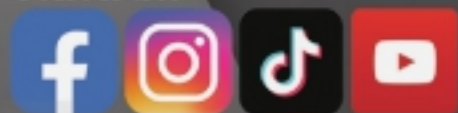



3348 Gateway Centre Parkway
Gainesville, GA 30507

PRSR STD
US POSTAGE
Paid
Permit #47
GAINESVILLE, GA

