



DODGE • PLYMOUTH E-BODY RESTORATION PARTS



SilentDrivePRO SOUND DAMPENING



AMD's new SilentDrive Pro Mat Sound Deadener offers premium noise reduction with three different versions to suit various needs. Two of the variants feature a 2mm thickness, with one showcasing blue lettering and the other white lettering for aesthetic preferences. For those seeking enhanced sound insulation, a thicker 7mm option is available. Each box includes 10 sheets, covering a total of 43 square feet, making it an excellent solution for reducing vibrations and road noise in vehicles or other applications requiring soundproofing.



403-1000-825B



403-1000-857

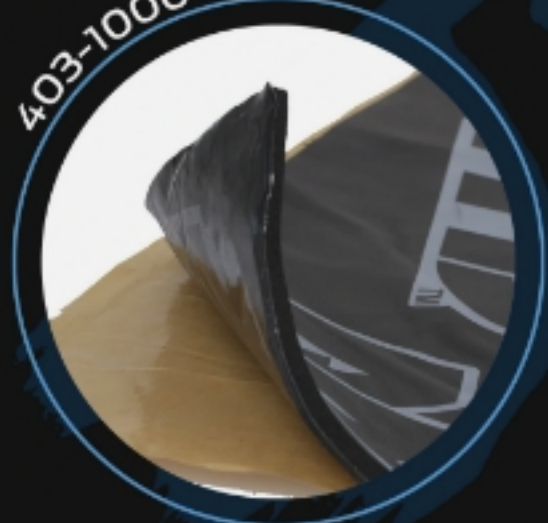



INDEX

Description	Page	Description	Page	Description	Page
Accelerator Pedal	24	Emblems	29	Power Windows	23
Antenna	11	Emergency Cable	18	Quarter Glass	26
A-Pillar	13	Engine Mount	32	Quarter Panel	19
Apparel	33	Exterior Trim	28	Radiator	8
Ashtray	23	Fastener	26	Rocker Panel	18
Back Glass	25	Fender, Front	9	Roof	13
Battery Tray	11	Firewall	12	Sail Panel	19
Body Bolts	27	Floor Pan	18	Seat Pan	18
Body Bumper	14	Floor Wiring	18	Shaker Bubble	6
Body Plugs	14	Frame Rail	17	Shift Ball	23
Bow Brace	19	Gas Tank	30	Shift Boot	23
B-Pillar	19	Gas Tank Sending Unit	30	Shifter Linkage	18
Brake Pedal	24	Glove Box	23	Shock Tower	10
Bumper, Front	4	Grille	7	Side Markers	24
Bumper, Rear	5	Header Panel	8	Spare Tire	20
Console	18	Headlamps	7	Splash Shields	10
Core Support	8	Heat Shields	32	Steering Gear	27
Cover Plates	10	Heater Box	12	Steering Wheel	23
Cowls	10	Hood	6	Stiffening	31
Crossmember	17	Ignition	15	Tail Lamp	21
Deck Filler Panel	20	Inner Fender	10	Torque Box	31
Deck Lid	20	Interior Trim	23	Transmission Tunnel	31
Dome Lights	23	Jack Bracket	22	Trunk	20
Door Bumpers	16	K-Frame	27	Turn Signal	24
Door Glass	26	Leaf Spring	31	U-Jamb Seals	19
Door Handles	15	License Plate	5	Valance, Front	8
Door Hinge	16	Master Chassis Hardware	27	Valance, Rear	21
Door Jamb Lock	19	Master Cylinder	12	Valve Covers	32
Door Lock	16	Mini-Tub	31	Washer Hose	25
Door Panel	16	Mirrors	15	Weld-In Frame	31
Door Repair	16	Moldings	28	Wheelhouse	19
Door Sills	23	Oil Filler	32	Window Crank	26
Door Skin	15	Package Tray	20	Window Felts	26
Door Track	26	Park Brake Pedal	24	Window Regulator	26
Drip Rail Seal	13	Park Lamps	24	Windshield	25
Driveshaft Loop	31	Parking Brake	18	Wiper Pivot	25

FRONT BUMPER



#	YEAR	DESCRIPTION	MODEL	PART #
1	70-71	Front Bumper - w/o Jack Slots	Barracuda	100-1570
2	70-71	Front Bumper - w/o Jack Slots	Challenger	100-2570
3	72	Front Bumper	Barracuda	100-1572
4	72	Front Bumper	Challenger	100-2572
5	73-74	Front Bumper	Barracuda	100-1573
6	73-74	Front Bumper	Challenger	100-2573
7	70-72	Front Bumper Bracket Set	Barracuda	105-1570-S
8	70-72	Front Bumper Bracket Set	Challenger	105-2570-S
9	70-74	Front Bumper Fillers - Pair	Challenger	F-064-S
10	70-74	Bumper Mounting Bolt Set - 16pcs	All E-Body	101-1000-16S
	70-74	Bumper Mounting Bolt Set - 24pcs	All E-Body	101-1000-24S
	70-74	Bumper Mounting Bolt Set - 32pcs	All E-Body	101-1000-32S

 VISIT US ONLINE
 FOR THE MOST
 UP-TO-DATE PRICING
 AND SELECTION





REAR BUMPER



6

7

8

9

10



11

12

#	YEAR	DESCRIPTION	MODEL	PART #
1	70-71	Rear Bumper - w/o Jack Slots	Barracuda	990-1570
	71-72	Rear Bumper - w/ Jack Slots	Barracuda	990-1572
	73	Rear Bumper	Barracuda	990-1573
	74	Rear Bumper	Barracuda	990-1574
2	70-71	Rear Bumper - w/o Jack Slots	Challenger	990-2570
	72	Rear Bumper	Challenger	990-2572
	73	Rear Bumper	Challenger	990-2573
	74	Rear Bumper	Challenger	990-2574
3	70-72	Rear Bumper Bracket Set	Barracuda	970-1570-S
4	70-72	Rear Bumper Bracket Set	Challenger	970-2570-S
5	70-72	Rear Bumper Filler	Challenger	975-2570
6	70-72	Rear Bumper Guards	Barracuda	980-1570-P
7	70-72	Rear Bumper Guards	Challenger	980-2570-P
8	70-72	Rear Bumper Guard Cushions - Pair	Challenger	F-360R
9	70-72	Rear Bumper Guard Bracket Set	Barracuda	981-1570-S
10	70-72	Rear Bumper Guard Bracket Set	Challenger	981-2570-S
11	70-74	License Plate Bumper	All E-Body	X102-1462
12	70-74	License Plate Screw & Nut	All E-Body	X102-1464



VISIT US ONLINE FOR THE MOST UP-TO-DATE PRICING AND SELECTION



Part Numbers Highlighted **BLUE** are Officially Licensed Mopar Authentic Restoration Products

HOOD



#	YEAR	DESCRIPTION	MODEL	PART #
1	70-74	Hood - Shaker w/ Hood Pin Holes	Barracuda	300-1570-2H
	70-74	Hood - Shaker Style	Challenger	300-2570-2
2	70-74	Hood - R/T Rallye w/o Pin Holes	Challenger	300-2570-1
3	70-74	Hood Hinges - Pair	All E-Body	310-1570-PK
4	70-74	Shaker Hood Trim Ring	Barracuda	321-1570
	70-74	Shaker Hood Trim Ring	Challenger	321-2570
5	70	Hood Latch and Support Assembly	Barracuda	X303-1570-S
	70	Hood Latch and Support Assembly	Challenger	X303-2570-S
	70-74	Hood Latch Support	All E-Body	X326-1570
6	70-74	Hood Inserts - R/T Rallye Style	Challenger	320-2570-S
7	70-74	Hood Stop / Bumper - 1.00" Diameter	All E-Body	A-151005
	70-74	Hood Stop / Bumper - 1.25" Diameter	All E-Body	A-150000
8	70-71	Shaker Bubble to Base Bolt Kit	All E-Body	A-270667
	70-74	Hood Wedge - Spring Loaded	All E-Body	F-228
	70-74	Hood Wedge Screw Set	All E-Body	F-228S
9	70-74	Hood Pop-up Spring	All E-Body	F-375
	70-74	Hood Side Bumper	Barracuda	F-617
	70-74	Hood Side Bumper	Challenger	F-658
	70-74	Hood Bumper - Rear Outer	Challenger	F-714
	70-74	Hood Pin Brackets	Barracuda	F-CHP
	70-74	Hood Bumper Kit	Challenger	F-HBK08
10	70-74	Hood Pin Set - w/ 18" Cables	Challenger	F-HP518
	70-74	Hood Pin Set - w/ 23" Cables	Barracuda	F-HP523
11	70-74	Hood Pin Cables - 18" - Pair	Challenger	F-HPC18
	70-74	Hood Pin Cables - 23" - Pair	Barracuda	F-HPC23
12	70	Under Hood Strap Kit	All E-Body	F-USK03
13	70-71	Under Hood Bolt Kit	All E-Body	A-270701
	72-74	Under Hood Bolt Kit	All E-Body	A-270702
	70-72	Hood Adjustment Bumper Set - 2pcs	Challenger	J-CH1010
	70-74	Hood Insulation - With Clips - (except Plymouth 2-door)	All E-Body	J-CH2062
	72-74	Hood Insulation Plastic Clip Kit	All E-Body	J-CH2069
14	70	Hood Hinge & Hood Hinge to Inner Fender Bolt Kit	All E-Body	X312-1570-1S
	71-74	Hood Hinge & Hood Hinge to Inner Fender Bolt Kit	All E-Body	X312-1570-2S
15	70-74	Hood to Cowl Seal - w/ Clips	All E-Body	J-CH3008



VISIT US ONLINE FOR THE MOST UP-TO-DATE PRICING AND SELECTION



WARNING: Cancer and Reproductive Harm - www.P65Warnings.ca.gov



AUTHENTIC RESTORATION PRODUCT

WWW.AUTOMETALDIRECT.COM

866.719.9505

GRILLE/HEADLIGHT



5

6



7



9

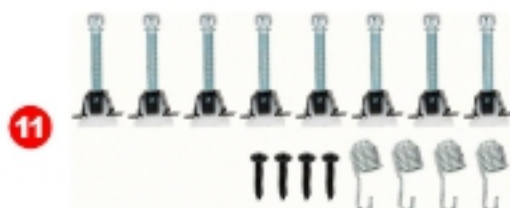

#	YEAR	DESCRIPTION	MODEL	PART #
1	70	Grille Set - Grille w/ Headlamp Bezels & Trim	Barracuda	K-ME1554
2	71	Grille Assembly	Barracuda	X150-1571-S
3	72-74	Grille	Barracuda	X150-1572
4	72-74	Grille Molding	Challenger	X155-2572
	70	Grille Hardware Kit	Challenger	X153-2570-S
	70	Grille Hardware Kit	Barracuda	A-271129
	71	Grille Hardware Kit	Challenger R/T	A-271121
	71	Grille Hardware Kit - (except R/T)	Challenger	A-271122
	71	Grille Hardware Kit	Barracuda	A-271130
	72-74	Grille Hardware Kit	Challenger	A-271123
	72-74	Grille Hardware Kit	Barracuda	A-271131
5	70	Headlamp Bezel - RH	Challenger R/T	X145-2570-R
6	70	Headlamp Bezel - LH	Challenger R/T	X145-2570-L
7	71	Headlamp Bezels - Pair	Challenger R/T	X145-2571-P
8	71	Headlamp Bracket Set	Barracuda	202-1571-S
9	70-74	Grille to Headlamp Bezel Retainer	Barracuda	A-C143
	71	Grille to Headlamp Bezel Retainer	Challenger	A-C143
10	70	Headlamp Adjuster Kit - 2 Headlights	Barracuda	A-280526
	72-74	Headlamp Adjuster Kit - 2 Headlights	Barracuda	X142-1072-2S
11	71	Headlamp Adjuster Kit - 4 Headlights	Barracuda	X142-1468-4S
11	70-71	Headlamp Adjuster Kit - 4 Headlights	Challenger	X142-1468-4S
	72-74	Headlamp Adjuster Kit - 4 Headlights	Challenger	X142-1472-4S



VISIT US ONLINE FOR THE MOST UP-TO-DATE PRICING AND SELECTION



Part Numbers Highlighted **BLUE** are Officially Licensed Mopar Authentic Restoration Products

HEADER PANEL



1



3



4



2

#	YEAR	DESCRIPTION	MODEL	PART #
1	70	Header Panel	Barracuda	130-1570
2	71	Header Panel	Barracuda	130-1571
3	72-74	Header Panel	Barracuda	130-1572
4	70-71	Header Panel Bolt Kit	Barracuda	X131-1570-S
	72-74	Header Panel Bolt Kit	Barracuda	A-270842

CORE SUPPORT/VALANCE

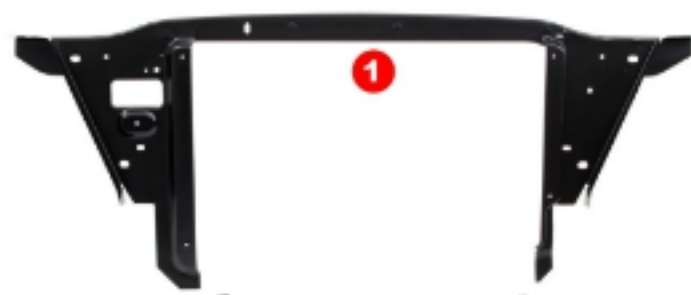

1

2

3



4



5



6



7



8



9



10

#	YEAR	DESCRIPTION	MODEL	PART #
1	70-74	Radiator Support - Upper	All E-Body	350-1570
2	70-74	Radiator Support - Lower	All E-Body	351-1570
3	70-74	Core Support Stiffener	All E-Body	X349-1570-1
4	70 & 72-74	Front Valance	Barracuda	125-1570
5	71	Front Valance	Barracuda	125-1571
6	70-71	Front Valance	Challenger	125-2570
7	70-72	Hood to Radiator Seal Clip Set - 11pcs	All E-Body	F-489-11
8	70	Radiator Cap - OE Style - Zinc - Loose Font 16#	All E-Body	X357-1067-Z
	70-74	Radiator Cap - OE Style - Zinc - Tight Font 16#	All E-Body	X357-1070-Z
9	70-71	Front Valance Bolt Kit - 16pcs	All E-Body	X128-1570-S
10	72-74	Front Valance Bolt Kit	All E-Body	A-270805



VISIT US ONLINE
FOR THE MOST
UP-TO-DATE PRICING
AND SELECTION



WARNING: Cancer and Reproductive Harm - www.P65Warnings.ca.gov



AUTHENTIC
RESTORATION
PRODUCT

WWW.AUTOMETALDIRECT.COM

866.719.9505



E-BODY

Part Numbers Highlighted BLUE are Officially Licensed Mopar Authentic Restoration Products

FENDER



1



2



3



9



10



11



12



4



5



6



7

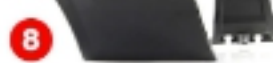

8

#	YEAR	DESCRIPTION	MODEL	PART #
1	70	Front Fender - LH	Barracuda	200-1570-L
	70	Front Fender - RH	Barracuda	200-1570-R
2	71	Front Fender - w/ Gill Slots - LH	Barracuda	200-1571-2L
	71	Front Fender - w/ Gill Slots - RH	Barracuda	200-1571-2R
3	71	Front Fender Louver Set	Barracuda	201-1571-S
4	72-74	Front Fender - LH	Barracuda	200-1572-L
	72-74	Front Fender - RH	Barracuda	200-1572-R
5	70-71	Front Fender - LH	Challenger	200-2570-L
	70-71	Front Fender - RH	Challenger	200-2570-R
6	72-74	Front Fender - LH	Challenger	200-2572-L
	72-74	Front Fender - RH	Challenger	200-2572-R
7	70-74	Front Fender Lower Rear Repair Panel w/ Brace - LH	Barracuda	205-1570-L
	70-74	Front Fender Lower Rear Repair Panel w/ Brace - RH	Barracuda	205-1570-R
8	70-74	Front Fender Lower Rear Repair Panel w/ Brace - LH	Challenger	205-2570-L
	70-74	Front Fender Lower Rear Repair Panel w/ Brace - RH	Challenger	205-2570-R
9	70-74	Wheel Opening Molding Set - 4pcs	Barracuda	F-BWM
	70-74	Wheel Opening Molding Set - 4pcs	Challenger	F-CWM
10	70-74	Wheel Opening Molding Screw Set - 36pcs	All E-Body	H-C-8021
11	70	Fender Bolt Kit - w/ Souds	All E-Body	X203-1570-S
12	70-74	Fender Bolts - 50pcs 5/16-18 x 7/8 3/4	All E-Body	15783

WWW
VISIT US ONLINE
FOR THE MOST
UP-TO-DATE PRICING
AND SELECTION



FENDER



#	YEAR	DESCRIPTION	MODEL	PART #
1	70-74	Fender Splash Shields	All E-Body	X251-1570-P
2	70-74	Fender to Cowl Brackets - Pair	All E-Body	261-1570-PK
3	70-74	Inner Fender Brace to Cowl Bracket - Pair	All E-Body	260-1570-1P
4	70-74	Cowl to Inner Fender Brace - LH	All E-Body	260-1570-3L
	70-74	Cowl to Inner Fender Brace - RH	All E-Body	260-1570-3R
5	70-74	Shock Tower to Inner Fender Brace - LH	All E-Body	249-1570-2L
	70-74	Shock Tower to Inner Fender Brace - RH	All E-Body	249-1570-2R
6	70-74	Front Shock Tower - LH	All E-Body	249-1466-L
	70-74	Front Shock Tower - RH	All E-Body	249-1466-R
7	70-74	Inner Fender to Cowl Bracket - Upper - LH	All E-Body	260-1570-2L
	70-74	Inner Fender to Cowl Bracket - Upper - RH	All E-Body	260-1570-2R
8	70-74	Inner Fender to Cowl Bracket - Lower - LH	All E-Body	260-1570-L
	70-74	Inner Fender to Cowl Bracket - Lower - RH	All E-Body	260-1570-R
9	70-71	Inner Fender - LH	All E-Body	250-1570-L
	70-71	Inner Fender - RH	All E-Body	250-1570-R
10	70-74	Inner Fender Cover Plates - Pair	All E-Body	255-1570-PK



VISIT US ONLINE
FOR THE MOST
UP-TO-DATE PRICING
AND SELECTION



WARNING: Cancer and Reproductive
Harm - www.P95Warnings.ca.gov



**AUTHENTIC
RESTORATION
PRODUCT**

WWW.AUTOMETALDIRECT.COM

866.719.9505

BATTERY



#	YEAR	DESCRIPTION	MODEL	PART #
1	70-74	Battery Tray	All E-Body	340-1570
2	70-71	Battery Hold Down Kit	All E-Body	X341-1370-1
3	72-74	Battery Hold Down Kit	All E-Body	X341-1472-5
4	70-74	7" Battery Hold Down J-bolt	All E-Body	F-814
5	70-74	8.5" Battery Hold Down J-bolt	All E-Body	F-89
6	70-74	Battery Tray Brace	All E-Body	X341-1570-2
7	70-74	Universal Battery Mat - 8" x 12"	All E-Body	J-BATTERYMAT1
8	70-74	Universal Battery Hold Down w/ J-Bolts	All E-Body	X341-4000-5

ANTENNA



#	YEAR	DESCRIPTION	MODEL	PART #
7	70-74	Antenna Assembly - (except AAR)	Barracuda	X280-1570
8	70-74	Antenna Mast - 3 Stage - 60"	All E-Body	F-658A
9	70	Antenna Adapter	AAR Cuda	F-925B
10	70	Antenna Bezel / Adapter	Challenger T/A	F-924
11	70-74	Antenna Adapter - (except AAR)	Barracuda	F-162
12	70-74	Antenna Adapter - (except T/A)	Challenger	F-164
10	70-74	Antenna Gasket	All E-Body	J-CH1025
11	70-74	Antenna Nut - Large	All E-Body	F-875

VISIT US ONLINE

 FOR THE MOST

 UP-TO-DATE PRICING

 AND SELECTION



COWL/FIREWALL

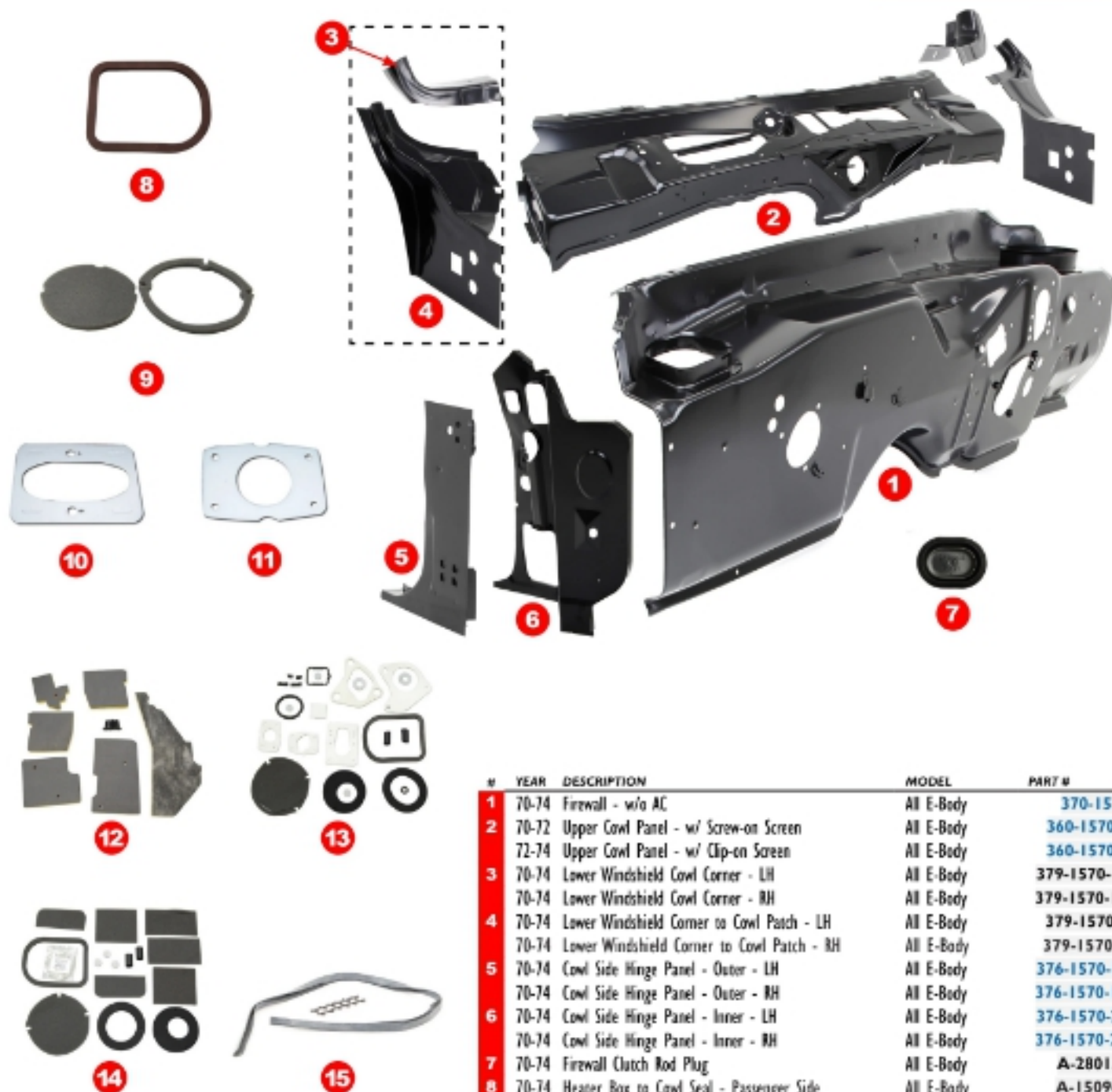

#	YEAR	DESCRIPTION	MODEL	PART #
1	70-74	Firewall - w/o AC	All E-Body	370-1570
2	70-72	Upper Cowl Panel - w/ Screw-on Screen	All E-Body	360-1570-1
	72-74	Upper Cowl Panel - w/ Clip-on Screen	All E-Body	360-1570-2
3	70-74	Lower Windshield Cowl Corner - LH	All E-Body	379-1570-1L
	70-74	Lower Windshield Cowl Corner - RH	All E-Body	379-1570-1R
4	70-74	Lower Windshield Corner to Cowl Patch - LH	All E-Body	379-1570-L
	70-74	Lower Windshield Corner to Cowl Patch - RH	All E-Body	379-1570-R
5	70-74	Cowl Side Hinge Panel - Outer - LH	All E-Body	376-1570-1L
	70-74	Cowl Side Hinge Panel - Outer - RH	All E-Body	376-1570-1R
6	70-74	Cowl Side Hinge Panel - Inner - LH	All E-Body	376-1570-2L
	70-74	Cowl Side Hinge Panel - Inner - RH	All E-Body	376-1570-2R
7	70-74	Firewall Clutch Rod Plug	All E-Body	A-280157
8	70-74	Heater Box to Cowl Seal - Passenger Side	All E-Body	A-150963
9	70-74	Fresh Air Vent to Cowl Seal - w/o AC	All E-Body	A-150964
10	70-74	Power Brake Booster to Firewall Gasket	All E-Body	J-CH1053
11	70-74	Master Cylinder Gasket - Standard & Power Brake	All E-Body	J-CH1054
12	70-74	Firewall Pad - w/o AC	All E-Body	A-151066
	70-74	Firewall Pad - w/ AC	All E-Body	A-151067
13	70-74	Firewall Gasket Set - w/ Wiper Pivots - w/o AC	All E-Body	A-151330
	70-74	Firewall Gasket Set - w/ Wiper Pivots - w/ AC	All E-Body	A-151331
14	70-74	Heater Box Seal Kit - w/o AC	All E-Body	A-151092
15	70-74	Hood to Cowl Seal - w/ Clips	All E-Body	J-CH3008



VISIT US ONLINE
FOR THE MOST
UP-TO-DATE PRICING
AND SELECTION



WARNING: Cancer and Reproductive
Harm - www.P65Warnings.ca.gov



**AUTHENTIC
RESTORATION
PRODUCT**

WWW.AUTOMETALDIRECT.COM |

866.719.9505

ROOF



#	YEAR	DESCRIPTION	MODEL	PART #
1	70-74	Roof Skin	Barracuda	600-1570
	70-74	Roof Skin	Challenger	600-2570
2	70-74	Windshield Outer A-Pillar Post - LH	All E-Body	375-1570-L
	70-74	Windshield Outer A-Pillar Post - RH	All E-Body	375-1570-R
3	70-74	Outer Roof Rail - LH	All E-Body	610-1570-6L
	70-74	Outer Roof Rail - RH	All E-Body	610-1570-6R
4	70-74	Upper Outer Sail Panel Connector to Roof Brace - LH	Barracuda	610-1570-3L
	70-74	Upper Outer Sail Panel Connector to Roof Brace - RH	Barracuda	610-1570-3R
5	70-74	Lower Outer Sail Panel Connector to Roof Brace - LH	Barracuda	610-1570-5L
	70-74	Lower Outer Sail Panel Connector to Roof Brace - RH	Barracuda	610-1570-5R
6	70-74	Upper Sail Panel to Rear Window Support - LH	Barracuda	610-1570-7L
	70-74	Upper Sail Panel to Rear Window Support - RH	Barracuda	610-1570-7R
7	70-74	Roof Drip Rails - Pair	Barracuda	620-1570-S
	70-74	Roof Drip Rails - Pair	Challenger	620-2570-S
8	70-74	Drip Rail Molding Set - 6pcs	Barracuda	630-1570-S
	70-74	Drip Rail Molding Set - 4pcs	Challenger	630-2570-S
9	70-71	Drip Rail Seal Set	All E-Body	A-150961
	71-74	Drip Rail Seal Set	All E-Body	A-150962
10	70	Roof Rail Weatherstrips - Pair - 2DR Hardtop	All E-Body	J-CH3016
	71-74	Roof Rail Weatherstrips - Pair - 2DR Hardtop	All E-Body	J-CH3017

VISIT US ONLINE

 FOR THE MOST

 UP-TO-DATE PRICING

 AND SELECTION



Part Numbers Highlighted **BLUE** are Officially Licensed Mopar Authentic Restoration Products

BODY BUMPERS/PLUGS



#	YEAR	DESCRIPTION	MODEL	PART #
1	70	Body Bumper Kit	Barracuda	F-BBK07
2	70	Body Bumper Kit	Challenger	F-BBK10
3	71	Body Bumper Kit	Barracuda	F-BBK08
4	71	Body Bumper Kit	Challenger	F-BBK11
5	72&74	Body Bumper Kit	Barracuda	F-BBK09
6	73-74	Body Bumper Kit	Challenger	F-BBK11A
7	73	Body Bumper Kit	Barracuda	F-BBK08A
8	70	Body Plug Kit	Barracuda	F-BPK1
9	70	Body Plug Kit - w/ 2 Shock Mount Plugs	Barracuda	F-BPK1A
10	70	Body Plug Kit	Challenger	F-BPK2
11	70	Body Plug Kit - w/ 2 Shock Mount Plugs	Challenger	F-BPK2A
12	71-74	Body Plug Kit	All E-Body	F-BPK3

 VISIT US ONLINE
 FOR THE MOST
 UP-TO-DATE PRICING
 AND SELECTION



 WARNING: Cancer and Reproductive
 Harm - www.P65Warnings.ca.gov



**AUTHENTIC
 RESTORATION
 PRODUCTS**

WWW.AUTOMETALDIRECT.COM

866.719.9505

DOOR



#	YEAR	DESCRIPTION	MODEL	PART #
1	70-74	Door Skin - LH	Barracuda	510-1570-L
	70-74	Door Skin - RH	Barracuda	510-1570-R
2	70-74	Door Skin - LH	Challenger	510-2570-L
	70-74	Door Skin - RH	Challenger	510-2570-R
3	70-74	Door Handles - Pair	Barracuda	CHEHDL704
4	70-74	Door Handles - Pair	Challenger	CHEHDL705
5	70-74	Door Handle & Lock Gasket Set - 4pcs	All E-Body	A-151000
6	70-71	Ignition & Door Lock Kit - w/o Illumination	All E-Body	A-280548
	72-74	Ignition & Door Lock Kit - w/o Tilt - w/o Telescoping	All E-Body	A-280550
7	70-74	Door Lock Set	All E-Body	A-280563
8	70-74	Door Lock Cylinder Retainer Clip	All E-Body	A-280540
	70	Door Mirror - Sport Style - Chrome - Manual - LH	All E-Body	X570-1570-2L
9	70	Door Mirror - Sport Style - Chrome - Manual - RH	All E-Body	X570-1570-2R
	71-74	Door Mirror - Sport Style - Chrome - Manual - RH	All E-Body	X570-1571-1R
10	71-74	Door Mirror - Sport Style - Chrome - Remote - LH	All E-Body	X570-1571-1L
11	70	Mirror Gasket	All E-Body	F-052
	71-74	Mirror Gasket - LH	All E-Body	A-151039
	71-74	Mirror Gasket - RH	All E-Body	A-151040
12	70-74	Mirror Mounting Kit	All E-Body	A-270275

VISIT US ONLINE
 FOR THE MOST
 UP-TO-DATE PDS (ING
 AND SELECTION



DOOR



2



3



4



5



6



7



8



11



12



13



14



15

#	YEAR	DESCRIPTION	MODEL	PART #
1	70-74	Inner Door Bottom Repair Panel - LH	All E-Body	515-1570-L
	70-74	Inner Door Bottom Repair Panel - RH	All E-Body	515-1570-R
2	70-74	Door Lock Pillar Seals - Pair	All E-Body	F-664-S
3	70-74	Door Lock Striker	All E-Body	K-ME8152
4	70	Door Bumpers - Rounded - Pair	All E-Body	J-CH1007
	72-73	Door Bumpers - Rectangular - Pair	All E-Body	J-CH1013
5	70-74	Door Rod Lock Clip	All E-Body	A-270004
6	70-72	Door Lock Rod Clip - LH	All E-Body	A-270023
	70-72	Door Lock Rod Clip - RH	All E-Body	A-270024
7	70-74	Door Panel Installation Clip	All E-Body	A-270515
8	70-74	Door Frame Plug Kit	All E-Body	A-280154
9	70-74	Door Hinge - Upper - LH	All E-Body	520-1570-L
	70-74	Door Hinge - Upper - RH	All E-Body	520-1570-R
10	70-74	Door Hinge - Lower - LH	All E-Body	525-1570-L
	70-74	Door Hinge - Lower - RH	All E-Body	525-1570-R
11	70-74	Door Hinge Bolt Kit	All E-Body	X521-1570-S
12	70-74	Lower Door Hinge Detent Spring	All E-Body	520-1000
13	70-74	Door Hinge Pin Kit	All E-Body	X521-1000-S
14	70-74	Door Handles - Inside - Pair	Barracuda	K-MD8423
15	70-74	Door Handles - Inside - Pair	Challenger	K-MD1701



VISIT US ONLINE
FOR THE MOST
UP-TO-DATE PRICING
AND SELECTION





E-BODY

Part Numbers Highlighted **BLUE** are Officially Licensed Mopar Authentic Restoration Products

FRAME

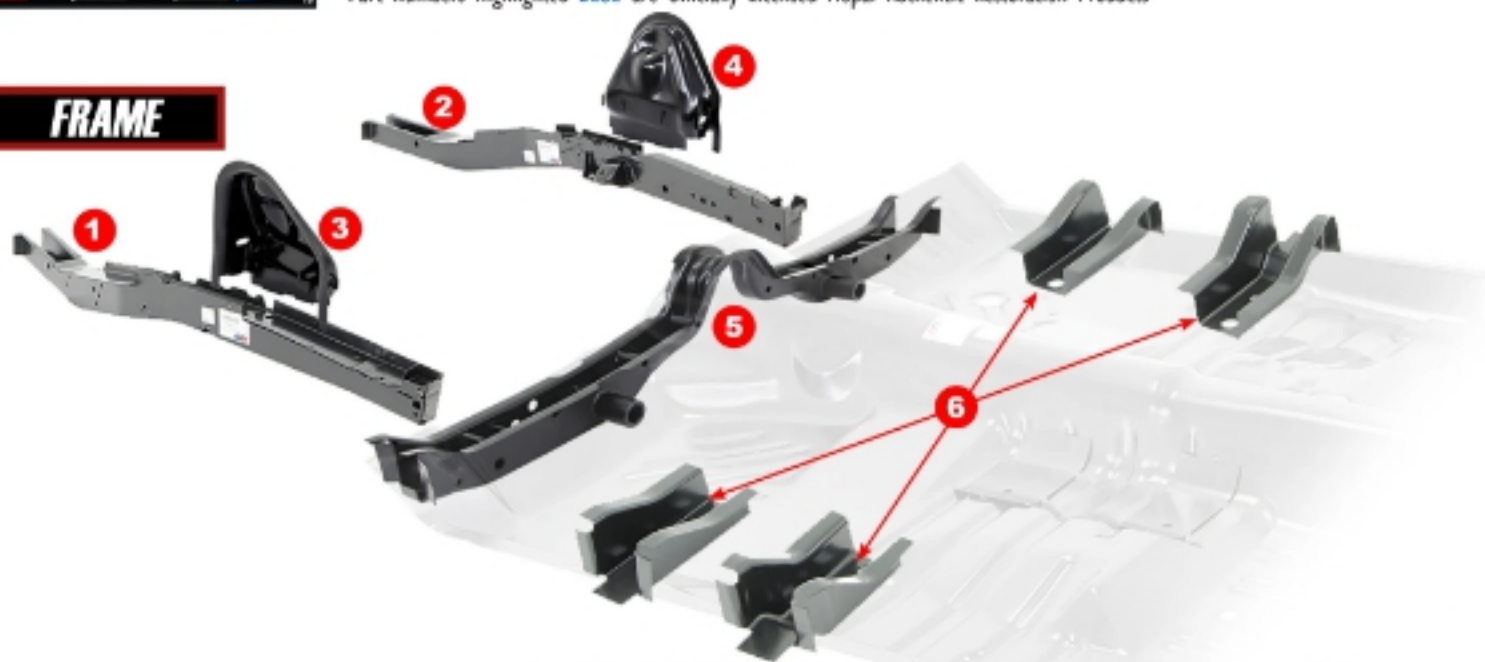

#	YEAR	DESCRIPTION	MODEL	PART #
1	70-74	Front Frame Rail - LH	All E-Body	391-1570-L
2	70-74	Front Frame Rail - RH	All E-Body	391-1570-R
3	70-74	Front Shock Tower - LH	All E-Body	249-1466-L
4	70-74	Front Shock Tower - RH	All E-Body	249-1466-R
5	70-74	Torsion Bar Crossmember - (71-74 Requires Modification)	All E-Body	395-1570
6	70-74	Main Floor Pan Support Set - 4pcs	All E-Body	425-1570-S



#	YEAR	DESCRIPTION	MODEL	PART #
7	70-74	Rear Frame Rail - LH	All E-Body	895-1570-L
8	70-74	Rear Frame Rail - RH	All E-Body	895-1570-R
9	70-74	Leaf Spring Mount - Front - LH	All E-Body	865-1570-1L
10	70-74	Leaf Spring Mount - Front - RH	All E-Body	865-1570-1R
11	70-74	Upper Rear Crossmember / Shock Mount	All E-Body	860-1570
12	70-74	Rear Crossmember	All E-Body	870-1570
13	70-74	Tail Lamp Panel Reinforcement Brackets - Pair	Barracuda	920-1570-S

WWW
VISIT US ONLINE
FOR THE MOST
UP-TO-DATE PRICING
AND SELECTION



Part Numbers Highlighted **BLUE** are Officially Licensed Mopar Authentic Restoration Products

FLOOR



11

12

13

14

#	YEAR	DESCRIPTION	MODEL	PART #
1	70	Front Floor Pan - OE Style	All E-Body	400-1570
	71-74	Floor Pan - OE Style	All E-Body	400-1571
2	70	Rear Footwell Area Floor Pan - LH	Challenger	410-2570-L
3	70	Rear Footwell Area Floor Pan - RH	Challenger	410-2570-R
4	70-74	Rear Floor / Under Rear Seat Pan	All E-Body	420-1570
5	70-74	Trunk Floor Braces - 2pcs	All E-Body	820-1570-P
6	70-74	Floor Wiring Cover Set	Barracuda	442-1570-S
	70-74	Floor Wiring Cover Set	Challenger	442-2570-S
7	70	Rocker Panel - Inner - LH	Barracuda	440-1570-L
	70	Rocker Panel - Inner - RH	Barracuda	440-1570-R
	70	Rocker Panel - Inner - LH	Challenger	440-2570-L
	70	Rocker Panel - Inner - RH	Challenger	440-2570-R
	71-74	Rocker Panel - Inner - LH	Barracuda	440-1571-L
	71-74	Rocker Panel - Inner - RH	Barracuda	440-1571-R
	71-74	Rocker Panel - Inner - LH	Challenger	440-2571-L
	71-74	Rocker Panel - Inner - RH	Challenger	440-2571-R
8	70-74	Rocker Panel - Outer - LH	Challenger	450-2570-L
	70-74	Rocker Panel - Outer - RH	Challenger	450-2570-R
	70-74	Rocker Panel - Outer - LH	Barracuda	450-1570-L
	70-74	Rocker Panel - Outer - RH	Barracuda	450-1570-R
9	70-74	Rocker Panel front End Cap - LH	All E-Body	451-1570-L
	70-74	Rocker Panel front End Cap - RH	All E-Body	451-1570-R
10	70-74	Console Bracket Set - Automatic Transmission	All E-Body	490-1570-AS
	70-74	Console Bracket Set - Manual Transmission	All E-Body	490-1570-MS
11	71-74	Console Screw Set	All E-Body	A-271113
12	70-74	Shifter Linkage Boot to Floor Seal	All E-Body	A-150942
13	70	Emergency Cable Bracket	All E-Body	441-1570
14	71-74	Parking Brake Release Rod Bushings	All E-Body	X377-1471-3



VISIT US ONLINE
FOR THE MOST
UP-TO-DATE PRICING
AND SELECTION



WARNING: Cancer and Reproductive
Harm - www.P95Warnings.ca.gov



AUTHENTIC
RESTORATION
PRODUCT

WWW.AUTOMETALDIRECT.COM

866.719.9505

REAR QUARTER



1



2



3



4

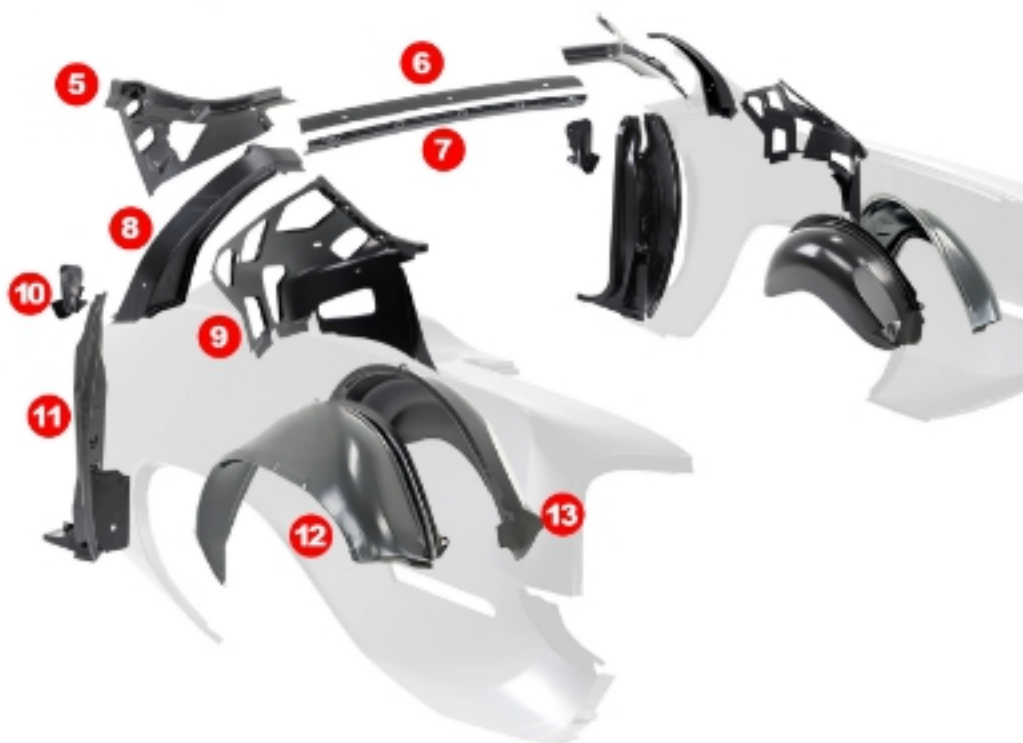

#	YEAR	DESCRIPTION	MODEL	PART #
1	70-71	Quarter Panel - OE Style - LH - Coupe	Barracuda	700-1570-L
	70-71	Quarter Panel - OE Style - RH - Coupe	Barracuda	700-1570-R
2	72-74	Quarter Panel - OE Style - LH	Barracuda	700-1572-L
	72-74	Quarter Panel - OE Style - RH	Barracuda	700-1572-R
3	70-71	Quarter Panel - OE Style - LH - Coupe	Challenger	700-2570-L
	70-71	Quarter Panel - OE Style - RH - Coupe	Challenger	700-2570-R
4	72-74	Quarter Panel - OE Style - LH	Challenger	700-2572-L
	72-74	Quarter Panel - OE Style - RH	Challenger	700-2572-R
	72-74	Quarter Panel - OE Style - RH	Challenger	700-2572-R
5	70-74	Upper Sail Panel To Rear Window Support - LH	Barracuda	610-1570-7L
	70-74	Upper Sail Panel To Rear Window Support - RH	Barracuda	610-1570-7R
6	70-74	Upper Rear Center Bow Brace	Barracuda	610-1570-1
7	70-74	Lower Rear Center Bow Brace	Barracuda	610-1570-1B
8	70-74	B-Pillar Vertical Post - Wheelhouse to Rear Window Frame - LH	Barracuda	610-1570-4L
	70-74	B-Pillar Vertical Post - Wheelhouse to Rear Window Frame - RH	Barracuda	610-1570-4R
9	70-74	Sail Panel To Rear Window Support Panel - LH	Barracuda	610-1570-2L
	70-74	Sail Panel To Rear Window Support Panel - RH	Barracuda	610-1570-2R
10	70-74	Quarter U-Jamb Seals - Pair	All E-Body	F-180-1
11	70-74	Door Jamb Lock Pillar - LH	Barracuda	750-1570-L
	70-74	Door Jamb Lock Pillar - RH	Barracuda	750-1570-R
	70-74	Door Jamb Lock Pillar - LH	Challenger	750-2570-L
	70-74	Door Jamb Lock Pillar - RH	Challenger	750-2570-R
12	70-74	Outer Wheelhouse - LH	Barracuda	770-1570-L
	70-74	Outer Wheelhouse - RH	Barracuda	770-1570-R
	70-74	Outer Wheelhouse - LH	Challenger	770-2570-L
	70-74	Outer Wheelhouse - RH	Challenger	770-2570-R
	70-74	Outer Wheelhouse - RH	Challenger	770-2570-R
13	70-74	Inner Wheelhouse - LH	All E-Body	760-1570-L
	70-74	Inner Wheelhouse - RH	All E-Body	760-1570-R
	70-74	3" Wider Inner Wheelhouse - LH	All E-Body	760-1570-1L
70-74	3" Wider Inner Wheelhouse - RH	All E-Body	760-1570-1R	

VISIT US ONLINE

 FOR THE MOST

 UP-TO-DATE PRICING

 AND SELECTION



Part Numbers Highlighted **BLUE** are Officially Licensed Mopar Authentic Restoration Products

TRUNK - UPPER



SEE PAGE 100 FOR
OE STYLE TRUNK FLOOR



#	YEAR	DESCRIPTION	MODEL	PART #
1	70	Deck Lid - w/ Spoiler Holes	Barracuda	850-1570-2
	70-71	Deck Lid - w/ Spoiler Holes	Challenger	850-2570-2
	70-74	Deck Lid - w/o Spoiler Holes	Barracuda	850-1570-1
	70-74	Deck Lid - w/o Spoiler Holes	Challenger	850-2570-1
	71	Deck Lid - w/ Spoiler Holes	Barracuda	850-1571
2	70-74	Deck Filler Panel	Challenger	650-2570
	70-74	Deck Filler Panel	Barracuda	650-1570
3	70-74	Package Tray	Barracuda	640-1570
	70-74	Package Tray	Challenger	640-2570
4	70-74	Trunk Lid Hinges - Pair	Challenger	K-MM1839
7	70-74	Trunk Hinge Retainer Clip - 2pcs	All E-Body	A-270230



#	YEAR	DESCRIPTION	MODEL	PART #
5	70	Trunk Floor Half - LH	Barracuda	805-1570-L
6	70	Trunk Floor Half - RH	Barracuda	805-1570-R
	70	Trunk Floor Half - LH	Challenger	805-2570-L
	70	Trunk Floor Half - RH	Challenger	805-2570-R
	71-74	Trunk Floor Half - LH	Barracuda	805-1571-L
	71-74	Trunk Floor Half - RH	Barracuda	805-1571-R
	71-74	Trunk Floor Half - LH	Challenger	805-2571-L
	71-74	Trunk Floor Half - RH	Challenger	805-2571-R
7	70-74	Trunk Gutter - LH	Barracuda	825-1570-L
8	70-74	Trunk Gutter - RH	Barracuda	825-1570-R
	70-74	Trunk Gutter - LH	Challenger	825-2570-L
	70-74	Trunk Gutter - RH	Challenger	825-2570-R
9	70-71	Trunk Bolt Kit	Challenger	A-270720
10	70-74	Spare Tire Hardware Set - Full Size	All E-Body	816-1570-6S
	70-74	Spare Tire Hardware Set - Space Saver	All E-Body	816-1570-8S
11	70-74	Spare Tire Wing Nut	All E-Body	816-1468-1



VISIT US ONLINE
FOR THE MOST
UP-TO-DATE PRICING
AND SELECTION



WARNING: Cancer and Reproductive
Harm - www.P95Warnings.ca.gov



AUTHENTIC
RESTORATION
PRODUCT

WWW.AUTOMETALDIRECT.COM

866.719.9505



E-BODY

Part Numbers Highlighted **BLUE** are Officially Licensed Mopar Authentic Restoration Products

TRUNK - LOWER



#	YEAR	DESCRIPTION	MODEL	PART #
1	70-71	Tail Lamp Panel	Barracuda	900-1570
2	72	Tail Lamp Panel	Barracuda	900-1572
3	73-74	Tail Lamp Panel	Barracuda	900-1573
4	70	Tail Lamp Panel	Challenger	900-2570
5	70	Rear Valance - w/ Exhaust Tip Cutouts	Barracuda	960-1570-T
	71-72	Rear Valance - w/ Exhaust Tip Cutouts	Barracuda	960-1571-T
	73-74	Rear Valance - w/ Exhaust Tip Cutouts	Barracuda	960-1573-T
	73-74	Rear Valance - w/o Exhaust Tip Cutouts	Barracuda	960-1573
6	70-71	Rear Valance - w/ Exhaust Tip Cutouts	Challenger	960-2570-T
	72-74	Rear Valance - w/ Exhaust Tip Cutouts	Challenger	960-2572-T
	72-74	Rear Valance - w/o Exhaust Tip Cutouts	Challenger	960-2572
7	70-71	Rear Valance Bolt Kit	All E-Body	X961-1570-1S
	72-74	Rear Valance Bolt Kit	All E-Body	A-270823
8	70-74	Rear Valance Bump Removal Panel	Barracuda	X960-1570-1P

WWW
VISIT US ONLINE
FOR THE MOST
UP-TO-DATE PRICING
AND SELECTION



TRUNK - LOWER



#	YEAR	DESCRIPTION	MODEL	PART #
9	70-74	Trunk Lock Support	Barracuda	810-1570
	70-74	Trunk Lock Support	Challenger	810-2570
10	70	Rear Valance Brackets - Pair	Barracuda	961-1570
	71-74	Rear Valance Brackets - Pair	Barracuda	961-1571
	70-71	Rear Valance Brackets	Challenger	961-2570
	70	Trunk Floor - OE Style	Barracuda	800-1570
11	71-74	Trunk Floor - OE Style	Barracuda	800-2571
	70	Trunk Floor - OE Style	Challenger	800-2570
	71-74	Trunk Floor - OE Style	Challenger	800-2571
	70-74	Trunk Floor Extension - LH	Barracuda	840-1570-L
12	70-74	Trunk Floor Extension - RH	Barracuda	840-1570-R
	70-74	Trunk Floor Extension - LH	Challenger	840-2570-L
	70-74	Trunk Floor Extension - RH	Challenger	840-2570-R
	13	Fuel Filler Tube to Trunk Floor Seal	All E-Body	F-151R
14	Jack Bracket - Rear	All E-Body	818-1570-2L	
15	Jack Bracket Spring Hook	All E-Body	818-1570-1L	
16	Jack Bracket - Front	All E-Body	818-1570-3L	
17	70-74	Spare Tire Hold Down Bracket - Hardtop	All E-Body	817-1570-1
	70-74	Spare Tire Hold Down Bracket - Convertible	All E-Body	817-1570-1



VISIT US ONLINE
FOR THE MOST
UP-TO-DATE PRICING
AND SELECTION



WARNING: Cancer and Reproductive
Harm - www.P95Warnings.ca.gov



**AUTHENTIC
RESTORATION
PRODUCT**

WWW.AUTOMETALDIRECT.COM |

866.719.9505

22

INTERIOR



#	YEAR	DESCRIPTION	MODEL	PART #
1	70	Rear View Mirror	All E-Body	K-MD7125
2	71 Early	Rear View Mirror - up to 12/12/1971	All E-Body	X645-1470
3	71-74	Rear View Mirror - after 12/15/1971	All E-Body	X645-1471
4	70-74	Door Sill Plates - Pair	All E-Body	T-MPS600
5	70-74	Door Sill Plate Screw Set	All E-Body	A-271107
6	70-74	Shift Boot Trim Ring Screw Kit	All E-Body	A-270298
7	70-71	Ignition & Door Lock Kit - w/o Illumination	All E-Body	A-280548
	72-74	Ignition & Door Lock Kit - w/o Tilt - w/o Telescoping	All E-Body	A-280550
8	70-74	Glove Box Door Bumpers - Pair	All E-Body	J-CH1069
9	70-74	Glove Box Door Bumper	All E-Body	X461-3062-5
10	70-74	Power Window Switch - 4 Buttons with Concave Buttons	All E-Body	K-2926117
11	70-74	Power Window Switch - 1 Button with Concave Button	All E-Body	K-2926118
12	70-74	Dome Light Assembly	All E-Body	S-EF3916
13	70-74	Dome Light Lens	All E-Body	X612-1466-1
14	70-74	Ashtray - Rear	All E-Body	X453-1466
15	70-74	Rim Blow and Tuff Steering Wheel Mounting Nut - Lug Nut Style	All E-Body	K-6029392
16	70-74	Interior Trim Screw Set - Hardtop	All E-Body	A-271002

VISIT US ONLINE

 FOR THE MOST

 UP-TO-DATE PRICING

 AND SELECTION



Part Numbers Highlighted **BLUE** are Officially Licensed Mopar Authentic Restoration Products

PEDAL

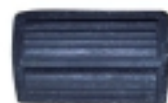

1

2

3

4

5

6



7

8

#	YEAR	DESCRIPTION	MODEL	PART #
1	70	Accelerator Pedal - w/ Hardware - w/o trim bezel	All E-Body	X409-1570-S
2	70	Accelerator Pedal - w/ Hardware - w/ trim bezel	All E-Body	X409-1570-TS
	71-72	Accelerator Pedal - w/ Hardware - w/o trim bezel	All E-Body	X409-1071-S
	71-72	Accelerator Pedal - w/ Hardware - w/ trim bezel	All E-Body	X409-1071-TS
	73-74	Accelerator Pedal - w/ Hardware - w/o trim bezel	All E-Body	X409-1073-S
	73-74	Accelerator Pedal - w/ Hardware - w/ trim bezel	All E-Body	X409-1073-TS
3	70-72	Brake Pedal Pad - Automatic	All E-Body	X476-1570-A
	73-74	Brake Pedal Pad - Automatic	All E-Body	X476-1071-A
4	70-72	Brake Pedal Pad Trim - Automatic	All E-Body	X476-1570-AT
	73-74	Brake Pedal Pad Trim - Automatic	All E-Body	X476-1071-AT
5	70-72	Brake-Clutch Pedal Pad - Manual	All E-Body	X476-1570-M
	73-74	Brake-Clutch Pedal Pad - Manual	All E-Body	X476-1071-M
	73-74	Brake-Clutch Pedal Pad - Manual	All E-Body	J-CH1052
6	70-72	Brake-Clutch Pedal Pad Trim - Manual	All E-Body	X476-1570-MT
7	70-72	Park Brake Pedal Pad	All E-Body	X476-1570-I
	73-74	Park Brake Pedal Pad	All E-Body	X476-1573
8	70-72	Park Brake Pedal Pad Trim	All E-Body	X476-1466-IT
	73-74	Park Brake Pedal Pad Trim	All E-Body	X476-1573-T

LIGHTING



1



2



3



4

5



6



7



8

#	YEAR	DESCRIPTION	MODEL	PART #
1	70-74	Park Lamp Assembly - LH	Challenger	K-ME8144
	70-74	Park Lamp Assembly - RH	Challenger	K-ME8145
2	70-74	Park Lamp Lenses - Pair	Challenger	F-552-3
3	72-74	Park Lamp Lens - LH	Barracuda	X135-1572-L
	72-74	Park Lamp Lens - RH	Barracuda	X135-1572-R
4	72-74	Park Lamp Bezel - LH	Barracuda	X136-1572-L
	72-74	Park Lamp Bezel - RH	Barracuda	X136-1572-R
5	72-74	Front Side Marker Lamp Lens - Amber	All E-Body	K-3587436
6	72-74	Rear Side Marker Lamp Lens - Red	All E-Body	K-3587440
7	70-71	Side Marker Reflector Set - 4pcs	Barracuda	F-CSM1R
8	70-72	Fender Mounted Turn Signal Gaskets - Pair	All E-Body	A-151003



VISIT US ONLINE
FOR THE MOST
UP-TO-DATE PRICING
AND SELECTION





E-BODY

Part Numbers Highlighted **BLUE** are Officially Licensed Mopar Authentic Restoration Products

GLASS



4



5



6



7



8



9



10

#	YEAR	DESCRIPTION	MODEL	PART #
1	70-74	Windshield - Clear	All E-Body	380-1570-C
2	70-74	Windshield - Green Tint	All E-Body	380-1570-T
3	70-74	Windshield Molding Set	All E-Body	385-1570-S
4	70	Windshield Molding Clips & Screw Set	All E-Body	X385-1570-1S
5	71-74	Windshield Molding Clips Set - 12pcs	All E-Body	X385-1571-11S
6	70-74	Windshield Washer Hose Kit - w/ Electric Pump & Steel Hood	All E-Body	F-WWK5
7	70-74	Windshield Washer Hose Kit - w/ Manual Pump & Steel Hood	All E-Body	F-WWK6
8	70-74	Wiper Arms - Silver - Pair	All E-Body	X382-1570-2P
9	70-74	Wiper Pivot Seal Kit	All E-Body	A-151304
10	70-74	Washer Hose T Connector - Black	All E-Body	F-077B



1

2



3

4



5



6



7

#	YEAR	DESCRIPTION	MODEL	PART #
1	70-74	Back Glass - Clear	Barracuda	660-1570-C
2	70-74	Back Glass - Green Tint	Barracuda	660-1570-T
3	70-74	Back Glass - Clear	Challenger	660-2570-C
4	70-74	Back Glass - Green Tint	Challenger	660-2570-T
5	70-74	Back Glass Molding Set	Barracuda	670-1570-S
6	70-74	Back Glass Molding Set	Challenger	670-2570-S
7	70	Back Glass Molding Clips & Screw Set - 20pcs	All E-Body	X671-1570-S
	71-74	Back Glass Molding Clips & Screw Set	All E-Body	H-C-8005

VISIT US ONLINE FOR THE MOST UP-TO-DATE PRICING AND SELECTION



Part Numbers Highlighted **BLUE** are Officially Licensed Mopar Authentic Restoration Products

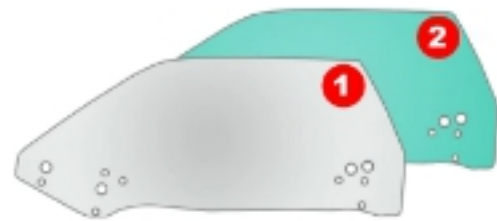

GLASS



5



6



7



8



9



10



11



12



13



14



15

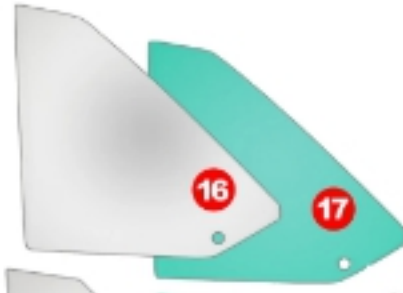

16

17



18

19



#	YEAR	DESCRIPTION	MODEL	PART #
1	70-71	Door Glass - Clear - LH - Convertible	All E-Body	550-1570-CVL
	70-71	Door Glass - Clear - RH - Convertible	All E-Body	550-1570-CVR
2	70-74	Door Glass - Clear - LH - 70-74 E-Body Hardtop	All E-Body	550-1570-CL
	70-74	Door Glass - Clear - RH - 70-74 E-Body Hardtop	All E-Body	550-1570-CR
3	70-74	Door Glass - Green Tint - LH - 70-74 E-Body Hardtop	All E-Body	550-1570-TL
	70-74	Door Glass - Green Tint - RH - 70-74 E-Body Hardtop	All E-Body	550-1570-TR
3	70-72	Door Window Hardware Kit	All E-Body	A-280086
4	73-74	Door Window Hardware Kit	All E-Body	A-280087
5	70-74	Door Glass Guide	All E-Body	A-270005
6	70-74	Window Regulator Arm Clip	All E-Body	A-270006
7	73-74	Door Window Roller	All E-Body	A-280088
8	73-74	Fastener Roller	All E-Body	A-280089
9	73-74	Door Glass Bushing	All E-Body	A-280090
10	70-74	Door Glass Up Stop	All E-Body	A-RIVET2
11	70-74	Door Track Rivet	All E-Body	A-RIVET3
12	71	Window Felts - O.E. Style Inner & Outer - 8pcs - Convertible	All E-Body	FPWX194
	71-74	Window Felts - O.E. Style Inner & Outer - 8pcs - Hardtop & Coupe	All E-Body	FPWX198
13	70-74	Window Crank Handle Spacers - Pair	All E-Body	K-MD35231
14	70-74	Door Glass Guide Set - LH	All E-Body	K-ME8148
14	70-74	Window Crank Handle - w/ Black Knob	All E-Body	X546-1068
15	70-74	Window Crank Handle Screw	All E-Body	X546-1068-3

#	YEAR	DESCRIPTION	MODEL	PART #
16	70-74	Quarter Glass - Clear - LH - Hardtop	Barracuda	795-1570-CL
	70-74	Quarter Glass - Clear - RH - Hardtop	Barracuda	795-1570-CR
17	70-74	Quarter Glass - Clear - LH - Hardtop	Challenger	795-2570-CL
	70-74	Quarter Glass - Clear - RH - Hardtop	Challenger	795-2570-CR
18	70-74	Quarter Glass - Green Tint - LH - Hardtop	Barracuda	795-1570-TL
	70-74	Quarter Glass - Green Tint - RH - Hardtop	Barracuda	795-1570-TR
19	70-74	Quarter Glass - Green Tint - LH - Hardtop	Challenger	795-2570-TL
	70-74	Quarter Glass - Green Tint - RH - Hardtop	Challenger	795-2570-TR
20	70-71	Quarter Glass - Clear - LH - Convertible	All E-Body	795-1570-CVL
	70-71	Quarter Glass - Clear - RH - Convertible	All E-Body	795-1570-CVR
20	70-71	Quarter Glass - Green Tint - LH - Convertible	All E-Body	795-1570-TVL
	70-71	Quarter Glass - Green Tint - RH - Convertible	All E-Body	795-1570-TVR
20	70-74	Quarter Window Roller Kit	All E-Body	A-280085



VISIT US ONLINE FOR THE MOST UP-TO-DATE PRICING AND SELECTION



WARNING: Cancer and Reproductive Harm - www.P65Warnings.ca.gov



AUTHENTIC RESTORATION PRODUCT

WWW.AUTOMETALDIRECT.COM

866.719.9505

HARDWARE



MASTER CHASSIS KIT INCLUDES:

DESCRIPTION	PIECES	DESCRIPTION	PIECES
Differential Carrier Cover - 9 3/4 - 3/8" HK Flng Bolts "E"	10	Brake Drum Retainers - 1/2" Stud, Green Push on Retain	6
Engine Insulator > Eng Brkt - exc HEMI - HK Nuts, Coni Wk's	4	Steering Linkage - Tri-dot Nuts, Coner Pins	12
Engine Mount Brackets - 383/440 - HK Bolts, 5/8 AF Nuts, Flat WK's	19	Wheel Cylinders (2) w 5/16-18 - 5/16-18 HK Ext Sens	4
Engine Insulator > Body - Y8 exc HEMI - HK Bolts "38", Coni Wk's	4	Brake Cable Tension Adjuster - Flange Lock Nut Only	1
Trans Insulator > Crossmember - Lock Nut	1	Proportioning Valve > Apron - Rod Flange Lock Nut	1
Wheel Cylinders (2) w 1/4-20 - Hs Flng Screws	4	Stabilizer Bar Center Supports - HK Coni Sens, HK Nuts	8
Strut Rod > K-Frame (B & E Body) - 5/8-11 Lock Nuts	4	Control Arms (JPR) - Coni Bolts, Washers, Nuts	16
Driveshaft > Flange - Straps, HK Bolts, Split WK's	10	Leaf Spring Mounting @ Front - "H" Marked Bolts, Marston Nut	4
Shocks (Fr) - Lwr Mounting - HK Bolts "IR" or "D", Lock Nuts	4	Idler Arm - "IR" Hex Bolt, Tri-Slot Nut, Pin	3
Leaf Spring Mounting @ Front - Hub Bolts, Coni Keys	16	K-Frame > Body - Special Hex Coni Sens	4
Shackles - Nuts Only - HK Nuts	4	Trans Crossmember - HK Bolts, Flat WK's, Coni Keys	12
Axle Bearings > Springs - 1/2-20 x 7.12 U-Bolts, Lock Nuts	12	Trans Insulator > Trans - HK Coni Screws	2
Suspension Bumper Brkt > 8 3/4 Axle - Hs Coni Sens "Anchor"	2	Axle Retaining Nuts - HK Lock Nuts, Flng Nut	10
Suspension Bumpers (R) - Hs Coni Sens "Anchor"	4	Ball Joints w/ Disc Brakes - HK Bolts, Slotted Nuts, Pins	12
Shocks (Fr) - Upr Mounting - Hs Bolts, Lock Nuts	4	Brake Calipers > Spindle - HK Bolts	4
Shocks (Fr) - Lwr Mounting - Hs Nuts Only	2	Pitman Arm - Nut, Split WA	2
Brake Rotor Shields - Hs Coni Sens	6	Brake Hoses > Bracket: Clips - U-Clips	3
Steering Gear (B body) - 16-Hs HD Bolts, Split WK's	6	Parking Brake Control > Body - EXT Keys	3
Brake Caliper Tube Brackets - HK Coni Sens	4	Master Cylinder - Ext Keys	4
Gas Tank - J-Bolts, Lock Nuts	4	Master Cylinder Support Plate - Coni Keys, EXT Keys, Sealer	4
Differential Carrier - 8 3/4 - Nuts w/ Nylon Pellet	10	Brake Booster - EXT Keys	4
Suspension Bumper Brkt > 9 3/4 Axle - Hs Coni Sens "Anchor"	3	Accelerator Pedal (B & E body) - Coni Keys, Coni Sens	6
Suspension Bumpers (Fr) - Hug-Lok Nuts	4		



Kit includes:

- Upper fender to lower fender slip-on nuts and dog point bolts with built in washer
- Front core support to fender slip on nuts and dog point bolts with built in washer
- Lower fender to rocker deep slip-on nuts, stud and washer with captured nut
- Hood to hood hinge bolts
- Hood Hinge to inner fender bolts
- Door Hinge to Door bolts (upper and lower)
- Door Hinge to A Pillar body bolts (upper and lower)
- Deck lid to Deck lid Hinge bolts

#	YEAR	DESCRIPTION	MODEL	PART #
1	70	Master Chassis Hardware Set - 383/440 with Disc Brakes	All E-Body	H-70E-BBDC
	70	Master Chassis Hardware Set - 270pcs - 383/440 with Drum Brakes	All E-Body	H-70E-BBDR
	70	Master Chassis Hardware Set - 264pcs - HEMI w/ Disc Brakes	All E-Body	H-70E-HEDC
	70	Master Chassis Hardware Set - 266pcs - HEMI w/ Drum Brakes	All E-Body	H-70E-HEDR
	70	Master Chassis Hardware Set - 264pcs - 318/340 w/ Disc Brakes	All E-Body	H-70E-SBDC
	70	Master Chassis Hardware Set - 266pcs - 318/340 w/ Drum Brakes	All E-Body	H-70E-SBDR
	71	Master Chassis Hardware Set - 266pcs - HEMI w/ Disc Brakes	All E-Body	H-71E-HEDC
	71	Master Chassis Hardware Set - 268pcs - HEMI w/ Drum Brakes	All E-Body	H-71E-HEDR
	71-72	Master Chassis Hardware Set - 256pcs - 383/440 w/ Disc Brakes	All E-Body	H-71B-BBDC
	71-72	Master Chassis Hardware Set - 272pcs - 383/440 w/ Drum Brakes	All E-Body	H-71B-BBDR
	71-72	Master Chassis Hardware Set - 256pcs - 318/340 w/ Disc Brakes	All E-Body	H-71B-SBDC
	71-72	Master Chassis Hardware Set - 258pcs - 318/340 w/ Drum Brakes	All E-Body	H-71B-SBDR
	73-74	Master Chassis Hardware Set - 266pcs - 400/440 w/Disc Brakes	All E-Body	H-73B-BBDC
	73-74	Master Chassis Hardware Set - 252pcs - 318/340/360 w/ Disc Brakes	All E-Body	H-73B-SBDC
2	70	Body Bolt Fastener Kit	All E-Body	X225-1570-1S
	71-74	Body Bolt Fastener Kit	All E-Body	X225-1570-2S
3	70-74	Steering Gear Bolts	All E-Body	X354-1466-1S
	70-74	K-Frame Bolts	All E-Body	X394-1466-1S



VISIT US ONLINE FOR THE MOST UP-TO-DATE PRICING AND SELECTION



Part Numbers Highlighted **BLUE** are Officially Licensed Mopar Authentic Restoration Products

MOLDING/TRIM

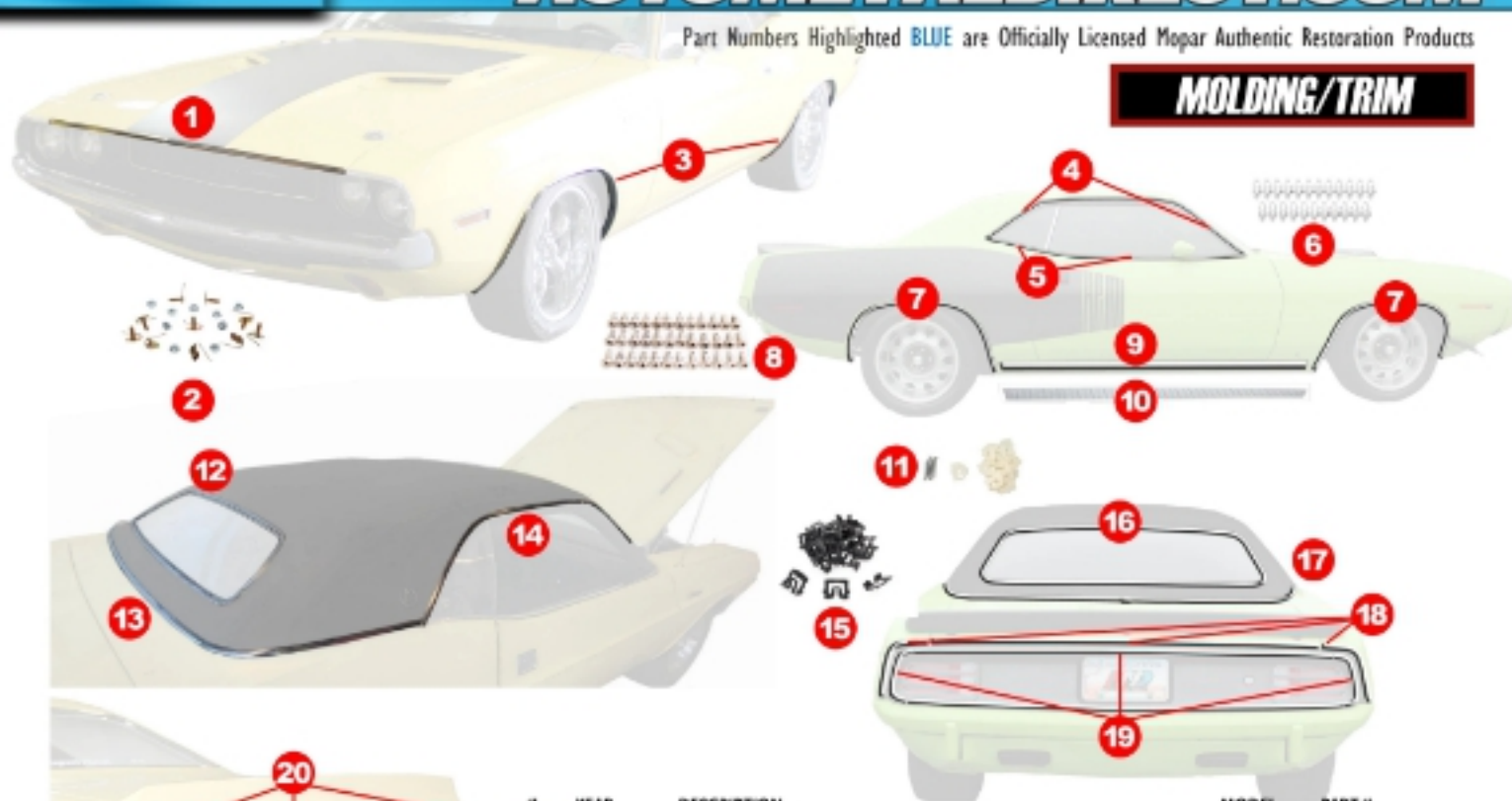

#	YEAR	DESCRIPTION	MODEL	PART #
1	70-71	Hood Molding w/ Clips - (except 71 R/T)	Challenger	F-CBM3
2	70	Hood Lip Molding Clip Set	Challenger	F-CBM3C
3	70-74	Wheel Opening Molding Set - 4pcs	Challenger	F-CWM
4	70-74	Drip Rail Molding Set - 6pcs	Barracuda	630-1570-S
5	70-74	Door & Quarter Top Edge Molding Set - 4pcs Anodized Aluminum	Barracuda	K-MN1472
6	70-71	Door Top Edge Moldings - Pair - Convertible	Barracuda	K-MN2114
7	71-74	Molding Hardware Set - Door Top Edge - 22pcs	Barracuda	K-MN1474
8	70-74	Wheel Opening Molding Set - 4pcs	Barracuda	F-BWM
9	70-74	Wheel Opening Molding Screw Set - 36pcs	All E-Body	H-C-8021
10	71-72	Rocker Panel Moldings - Pair	Barracuda	K-MN1452
11	70	Rocker Panel Moldings - Fish Gill Style - Pair	Barracuda	K-MN1930
12	71-74	Rocker Molding Clip Set (except 70 Challenger)	All E-Body	A-270270
13	70-74	Back Glass Molding Set (except SE)	Challenger	670-2570-S
14	70-74	Vinyl Top Molding Set	Challenger	635-2570-S
15	70-74	Drip Rail Molding Set - 4pcs	Challenger	630-2570-S
16	70-71	Door Top Molding Clip Set	Challenger	A-270289
17	70-74	Back Glass Molding Set (Except Gran Coupe)	Barracuda	670-1570-S
18	70-74	Vinyl Top Molding Set	Barracuda	635-1570-S
19	70-74	Trunk & Quarter Panel Molding Kit	Barracuda	X855-1570-S
20	70-71	Rear Body Panel Moldings - 4pcs	Barracuda	K-ME5062
21	70	Trunk & Quarter Panel Molding Set - 3pcs	Challenger	F-CBM1
22	71-74	Trunk & Quarter Panel Molding Set	Challenger	F-CBM2
23	70	Quarter Panel Molding - RH	Challenger	K-3419712
24	70	Quarter Panel Molding - LH	Challenger	K-3419713
25	71-74	Trunk & Quarter Panel Molding Hardware Set	Challenger	F-CBM4
26	70-74	Trunk & Quarter Panel Molding Clip Kit	All E-Body	A-270283
27	70-74	Exterior Trim Screw Set	Challenger	A-271200
	70-74	Exterior Trim Screw Set	Barracuda	A-271223
	70-74	Window Reveal Molding Clips - 25pcs	All E-Body	10242
	70-74	Body Molding Screw Set - 10Pcs	All E-Body	H-137
	70-74	Window Clip and Reveal Molding Soud Replacement Set - 25Pcs	All E-Body	X385-3000-25



VISIT US ONLINE FOR THE MOST UP-TO-DATE PRICING AND SELECTION



WARNING: Cancer and Reproductive Harm - www.P65Warnings.ca.gov



AUTHENTIC RESTORATION PRODUCT

WWW.AUTOMETALDIRECT.COM

866.719.9505

EMBLEMS

PLYMOUTH

1

Challenger

2

Challenger

3

R/T

4

Barracuda

5

Challenger

6

V-8

7

8 **383**
FOUR BARREL

8

9 **383**
FOUR BARREL

9

10 **cuda 340**

10

13 **383 MAGNUM**

13

11 **cuda 383**

11

14 **440 MAGNUM**

14

12 **cuda 440-6**

12

15 **440**

15

16 PLYMOUTH

16

17 *Challenger*

17

18 **Barracuda**

18

19 *Barracuda*

19

20 *Challenger*

20

#	YEAR	DESCRIPTION	MODEL	PART #
1	70	Grille Emblem - "Plymouth"	Barracuda	K-2998282
2	70	Grille Emblem - "Challenger"	Challenger	999-2570-11
3	72-74	Grille Emblem - "Challenger"	Challenger	K-3573505
4	70	Grille Emblem - "R/T"	Challenger	T-MP6045
5	70	Fender Emblem with Black Trim - "Barracuda"	Barracuda	K-2786559
6	70	Fender Emblem - "Challenger"	Challenger	999-2570-21
7	70	Fender Emblem - "V-8" - LH or RH	All E-Body	K-2579748
8	70	Fender Emblem - "383" - LH or RH	All E-Body	K-2579804
9	70-71	Fender Emblem with Red Accent - "383" - LH or RH	All E-Body	K-2785749
10	70-73	Hood Emblem - "Cuda 340"	Barracuda	K-3443159
11	70-71	Hood Emblem - "Cuda 383" - LH or RH	Barracuda	K-2998796
12	70-71	Hood Emblem - "Cuda 440-6" for Rallye Hood - LH or RH	Barracuda	K-2998798
13	70-71	Hood Emblem - "383 Magnum"	Challenger	K-2998801
14	70-71	Hood Emblem - "440 Magnum"	Challenger	K-2998802
15	70	Hood Emblem - "440"	All E-Body	K-3613278
16	70-72	Hood or Rear Deck Emblem - "PLYMOUTH"	Barracuda	K-2785791
17	70-74	Trunk Lid, Fender & Quarter Panel Emblem - Adhesive Backed Design	Challenger	K-3444938
18	71-74	Door & Tail Panel Emblem - "Barracuda"	Barracuda	K-3505456
19	71-74	Dash Pad Emblem - "Barracuda" Script	Barracuda	K-3590126
20	71-74	Dash Pad Emblem - "Challenger" Script	Challenger	K-3590127



VISIT US ONLINE
FOR THE MOST
UP-TO-DATE PRICING
AND SELECTION



GAS TANK



#	YEAR	DESCRIPTION	MODEL	PART #
1	70	Gas Tank - 19 Gallon - w/ 1 Side Vent Line	Barracuda	890-1570-1
2	71-71	Gas Tank - 18 Gallon - w/ 4 Side Vent Lines	Barracuda	890-1571
3	72-74	Gas Tank - 18 Gallon - w/ 4 Front Vent Lines	Barracuda	890-1572-4
4	70	Gas Tank - 18 Gallon - w/o Vent Line	Challenger	890-2570
5	71-72	Gas Tank - 18 Gallon - w/ 4 Side Vent Lines	Challenger	890-2571-4
6	72-74	Gas Tank - 18 Gallon - w/ 4 Front Vent Lines	Challenger	890-2572-4
7	70-74	Gas Tank Pad	All E-Body	F-TIPS
8	70-74	Gas Tank Straps - Pair	All E-Body	X880-1570-P
9	70-74	Gas Tank Strap Hardware Kit - 4 pcs	All E-Body	X880-1000-1S
10	70-74	Gas Tank Sending Unit - 3/8 Outlet - w/ Return Line	All E-Body	881-1570-3R
11	70-74	Gas Tank Sending Unit - 5/16 Outlet - w/o Return Line	All E-Body	881-1570-5
12	70-74	Sending Unit Float Brass	All E-Body	A-240075
13	70-74	Sending Unit Sock Filter 5/16	All E-Body	A-240076
	70-74	Sending Unit Sock Filter 3/8	All E-Body	A-240077
14	70-74	Sending Unit Ground Strap - Steel	All E-Body	K-MF290
15	70-74	Flip-up Cap	Challenger	X888-2570-1
16	70-74	Flip-up Cap Trim Ring	Challenger	F-666R
17	70-71	Gas Cap - Paintable	Challenger	K-ME1756
	72-74	Gas Cap - Paintable	Challenger	K-ME1757
18	70-74	Filler Neck	Barracuda	K-ME8150
19	70-74	Filler Neck Grommet - 2" Diameter - w/ Double Lip	All E-Body	891-1570-1
20	70-74	Gas Tank Anti-Squeak 5-Piece Kit	All E-Body	W-862A

 VISIT US ONLINE
 FOR THE MOST
 UP-TO-DATE PRICING
 AND SELECTION



CHASSIS STIFFENING

Level 1 Kit Includes:

- Weld-in Frame Connectors
- Front & Rear Torque Boxes

Level 2 Kit Includes:

- Weld-in Frame Connectors
- Front & Rear Torque Boxes
- Inner Fender Braces
- Lower Radiator Core Support Brace

Level 3 Kit Includes:

- Weld-in Frame Connectors
- Front & Rear Torque Boxes
- Inner Fender Braces
- Lower Radiator Core Support Brace
- Rear Spring Relocation Kit
- Mini Tub Kit

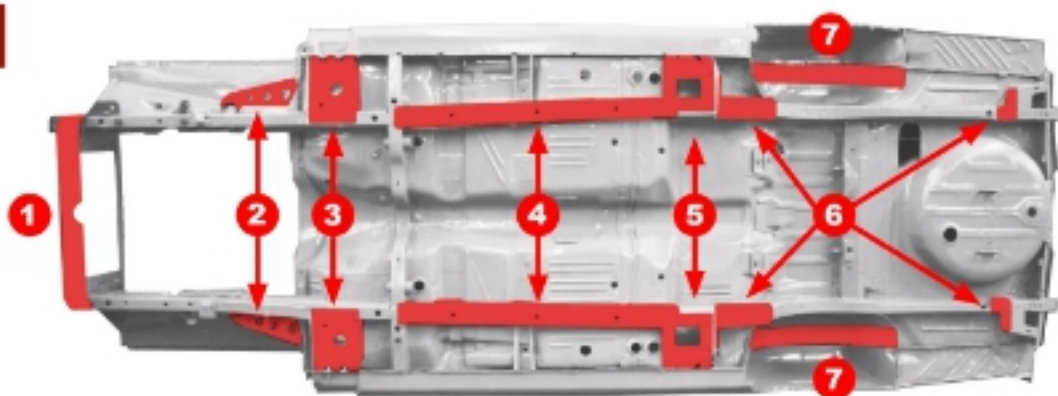

8



9



10



11



12



13

#	YEAR	DESCRIPTION	MODEL	PART #
	70-74	Level 1 Chassis Stiffening Set	Barracuda	X897-1570-1S
	70-74	Level 2 Chassis Stiffening Set	Barracuda	X897-1570-2S
	70-74	Level 3 Chassis Stiffening Set	Barracuda	X897-1570-3S
	70-74	Level 1 Chassis Stiffening Set	Challenger	X897-2570-1S
	70-74	Level 2 Chassis Stiffening Set	Challenger	X897-2570-2S
	70-74	Level 3 Chassis Stiffening Set	Challenger	X897-2570-3S
1	70-74	Core Support Stiffener	All E-Body	X349-1570-1
2	70-74	Inner Fender Brace Set	All E-Body	X253-1570-5
3	70-74	Front Torque Boxes - Pair	All E-Body	X439-1570-1S
4	70-74	Weld-in Frame Connectors	Barracuda	X896-1570-P
	70-74	Weld-in Frame Connectors	Challenger	X896-2570-P
5	70-74	Rear Torque Boxes - Pair	All E-Body	X439-1570-2S
	70-74	Front & Rear Torque Box Set - 4pcs	All E-Body	X439-1570-4S
6	70-74	Leaf Spring Relocation Set	All E-Body	X865-1570-1S
7	70-74	Mini-Tub Set	All E-Body	X760-1570-1S
	70-74	Mini-Tub and Spring Relocation Set	All E-Body	X760-1570-2S
8	70-74	K-frame Adapters - Pair	All E-Body	X394-1466-2P
9	70-74	Crossmember Set - 518 Transmission	All E-Body	X395-1570-2
10	70-74	Crossmember Set - MAG1 5 spd - HP70 8 spd	All E-Body	X395-1570-3
11	70-74	Tremec T56 Magnum Transmission Crossmember - Gen3 Hemi Swap	All E-Body	X395-1570-4
12	70-74	Bolt-in Driveshaft Loop	All E-Body	X419-1464-1
13	70-74	Transmission Tunnel Perimeter Frame	All E-Body	X428-1570-1



VISIT US ONLINE
FOR THE MOST
UP-TO-DATE PRICING
AND SELECTION



ENGINE



#	YEAR	DESCRIPTION	MODEL	PART #
1	70-71	Valve Covers - Pair	Small Block	335-1070-1PK
2	70	Valve Covers - Pair	Challenger T/A; AAR Barracuda	335-1070-2PK
3	70	Valve Covers - Pair	Big Block 383/440HP/440+6	335-1070-BPK
4	71-72	Valve Covers - Pair	Big Block 383/440HP/440+6	335-1071-BPK
5	72	Valve Covers - Pair	Small Block	335-1072-1PK
6	70-71	Valve Cover Gaskets - Pair	Small Block	336-1070-1S
	70-72	Valve Cover Gaskets - Pair	Big Block	336-1064-S
7	70-72	Valve Cover PCV Valve Grommet	All E-Body	336-1067-1
	70-72	Valve Cover Crankcase Breather Grommet	All E-Body	336-1070-1
8	70-74	Valve Cover Fasteners - 12pcs - 273/318/340/360	All E-Body	H-C-8032
9	70-74	Valve Cover Fasteners - 16pcs - 383/440	All E-Body	H-C-8033
10	71	Valve Cover Fasteners - 40pcs - 426 Hemi	All E-Body	H-C-8035
	70	Valve Cover Fasteners - 40pcs - HEMI	All E-Body	H-C-8015
	70	Valve Cover Bolt Kit - HEMI Only	All E-Body	A-270742
	71	Valve Cover Bolt Kit - HEMI Only	All E-Body	A-270743
11	70-72	Oil Filler Cap	All E-Body	337-1070
12	70-74	Oil Filler Breather Cap w/ 1 Hose Outlet	All E-Body	337-1070-1
13	70-74	Oil Filler Breather Cap w/ 2 Hose Outlet	All E-Body	337-1070-2
14	70-74	Oil Filler Breather Cap w/ 3 Hose Outlet	All E-Body	337-1070-3
15	70-74	Exhaust Heat Shields - Pair	All E-Body	885-1570-S
16	70-74	Engine Mount Bracket Bolt Set - 383/440/426	All E-Body	H-C-8086
	70-74	Engine Mount Bracket Bolt Set - 318/340/360	All E-Body	H-C-8087

 VISIT US ONLINE
 FOR THE MOST
 UP-TO-DATE PRICING
 AND SELECTION





E-BODY

Part Numbers Highlighted **BLUE** are Officially Licensed Mopar Authentic Restoration Products



Show your Mopar pride with our high quality t-shirts. These are high quality Next Level shirts that runs small in size. They are super soft, comfortable, and an perfect every day use t-shirt!

Size = Small thru 5XL
60% Cotton, 40% Polyester

Our popular Mopar shirt design is also available in a Hoodie!
Featuring a awesome Cuda and a pro touring Charger. Show off your Mopar and support for your favorite Mopar restoration parts supplier - Auto Metal Direct!

* Pre-Shrunk fleece knit with a softer feel keeping you warm and cozy.

APPAREL



DESCRIPTION

- Mopar T-Shirt - Small - Black
- Mopar T-Shirt - Medium - Navy
- Mopar T-Shirt - Large - Navy
- Mopar T-Shirt - X-Large - Navy
- Mopar T-Shirt - 2X-Large - Navy
- Mopar T-Shirt - 3X-Large - Navy
- Mopar T-Shirt - 4X-Large - Navy
- Mopar T-Shirt - 5X-Large - Navy
- Mopar Hoodie - Small - Black
- Mopar Hoodie - Medium - Black
- Mopar Hoodie - Large - Black
- Mopar Hoodie - X-Large - Black
- Mopar Hoodie - 2X-Large - Black
- Mopar Hoodie - 3X-Large - Black
- Mopar Hoodie - 4X-Large - Black
- Mopar Hoodie - 5X-Large - Black

PART

- AMDMOPAR-S**
- AMDMOPAR-M**
- AMDMOPAR-L**
- AMDMOPAR-XL**
- AMDMOPAR-2XL**
- AMDMOPAR-3XL**
- AMDMOPAR-4XL**
- AMDMOPAR-5XL**
- AMDMOPAR-HOOD-S**
- AMDMOPAR-HOOD-M**
- AMDMOPAR-HOOD-L**
- AMDMOPAR-HOOD-XL**
- AMDMOPAR-HOOD-2XL**
- AMDMOPAR-HOOD-3XL**
- AMDMOPAR-HOOD-4XL**
- AMDMOPAR-HOOD-5XL**



HATS



This Auto Metal Direct hat is the original Flexfit cap with poly-weave spandex to assure you get the perfect fit.



Classic AMD embroidered trucker cap built with the Richardson 112 quality and fit you've come to expect from premium headwear.

#	DESCRIPTION	PART #
1	AMD Black Flexfit Cap	AMDHAT-2
2	AMD Black Snapback Cap	AMDHAT-3

SHOP BANNER



Don't forget about our premium AMD vinyl logo sign banner. Made from 16oz vinyl, UV printing, and laminated, it's made to withstand the test of time. It comes complete with metal grommets at each corner for easy installation.

**Measures 4" X 3"*

#	DESCRIPTION	PART #
1	AMD Logo Banner 4' x 3' with grommets	AMDBANNER4X3

 VISIT US ONLINE
 FOR THE MOST
 UP-TO-DATE PRICING
 AND SELECTION



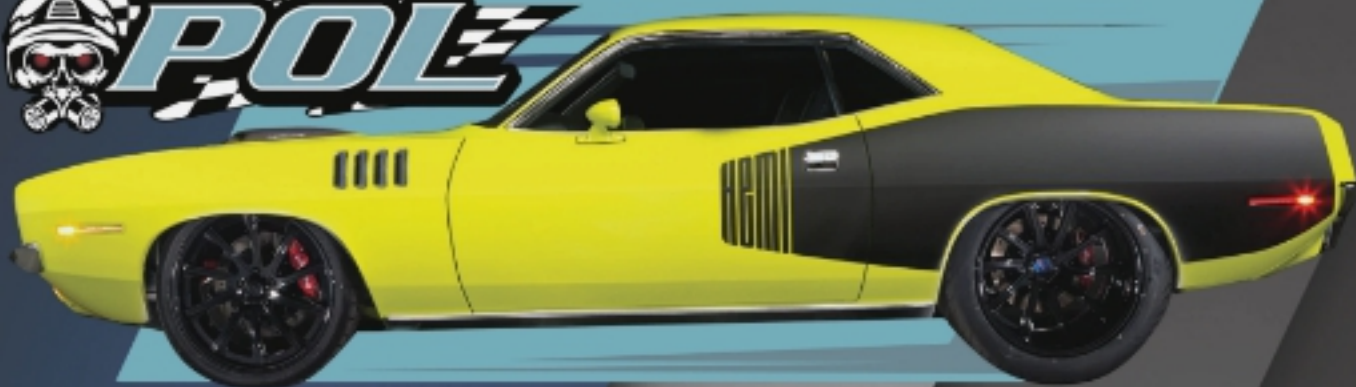

MASTER CYLINDERS



DISC BRAKES



FRONT END REBUILD KIT



TUBULAR CONTROL ARM KITS



DROP SPINDLES



ADJUSTING TIE ROD ENDS



MONO LEAF SPRINGS



STEERING

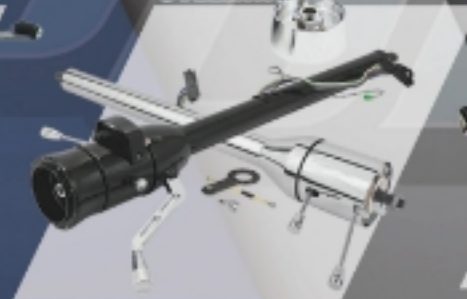

CALTRAC TRACTION BARS



800.638.1703

1550 MELISSA CT. CORONA, CA 92879

performanceonline.com

Follow us:

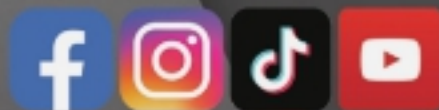

LEED
BRAKES

A, B&E, C BODY MOPAR



1965 & UP

**Chrysler, Dodge
& Plymouth**



**DISC BRAKE
CONVERSIONS**

1965 & UP

**Chrysler, Dodge
& Plymouth**

**BRAKE
BOOSTERS
&
MASTER
CYLINDERS**



3248 UNION RD. CHEEKTOWAGA, NY 14227 | 716-852-2139 | LEEDBRAKES.COM |   @LEEDBRAKES

FiTech
Fuel Injection

3
YEAR
WARRANTY
FiTech

**UNIVERSAL EFI
SYSTEMS FOR
YOUR CLASSIC**



TRIPower SYSTEMS

THROTTLE BODY SYSTEMS

CLASSIC EFI SYSTEMS



- Easy, bolt-on systems
- Fully equipped kits
- Self-learning EFI
- Enhanced fuel efficiency
- Quick starts, every time

FOR MORE INFO VISIT:

FITECHEFI.COM

OR CALL:

(951) 340-2624



ORDERING INFORMATION

Internet Orders

Shop our complete product offering anytime online at autometaldirect.com. Here you will find our most up-to-date product offerings, pricing, inventory and information. Join our community of customer rides or browse through our selection of installation videos.

Phone Orders

Feel free to call us toll-free at 833.404.4443 from anywhere in the U.S. or Canada. Our sales staff has a wealth of knowledge and first-hand experience and can assist you with any questions you may have. Our call center hours are 8:00 a.m. - 6:00 p.m. Monday - Friday, Eastern Standard. Our call center is closed on Saturday and Sunday and some U.S. Federal Holidays.

Customer Pick Up Orders

AMD offers a customer pick-up option at no additional fee. We encourage this option whenever possible to save you money on shipping your order. You can pick up your order from our retail store located at 3348 Gateway Centre Parkway, Gainesville, GA 30507. We HIGHLY recommend placing your order prior to arriving at our location to save you time. Feel free to call us toll-free at 833.404.4443 from anywhere in the U.S. or Canada. Our retail showroom hours are 8:00 a.m. - 5:00 p.m. Monday - Friday, Eastern Standard Time. Our retail showroom is closed on Saturday and Sunday and some U.S. Federal Holidays.

International Orders

For orders outside the United States or Canada, please utilize our website for international orders or call us by dialing the international access code then 1.770.967.0909.

PAYMENT METHODS

Credit / Debit Cards

We gladly accept Visa, Mastercard, Discover or American Express credit cards and Visa and Mastercard Debit Cards. We must be able to verify the shipping address on your card before shipment.

PayPal

We will accept Paypal for online orders that are shipped via FedEx Ground inside the continental U.S.

Check / Money Order / Other

We accept payments via money order, personal check, business check or cashier's check. We reserve the right to hold orders until payment clears. We cannot ship any order via C.O.D.

SHIPPING

Ground Shipments

AMD utilizes FedEx Ground for small parcel shipments. We do offer Express Ground (1,2, or 3 day) for an additional fee. Please inform your salesperson or notate on your order if you would like to utilize a Express method. Delivery dates are expectations and are not guaranteed.

Oversize Box Shipments

Oversize package fees are assessed on a per piece basis depending on the shipping size of the product. Oversize fees are in addition to the flat rate ground shipping fee.

Truck Freight

Any item(s) too large to ship FedEx Ground will be shipped via truck freight. Please check autometaldirect.com for the most up-to-date shipping zones and freight charges under the Shipping & Returns tab at the top of the website.

Damages

ALL TRUCK FREIGHT SHIPMENTS MUST BE INSPECTED AT THE TIME OF DELIVERY! If you find any damages you must contact AMD as soon as possible. If your shipment contains damage, please note 'DAMAGED' with the freight carrier at time of delivery and call us immediately at 866.591.8309. AMD will work with you and the freight carrier to find the best solution.

Additional Boxing Fees

Due to the fragile nature of glass, we have gone the extra mile in packaging orders that contain individual glass pieces and glass kits. The following charges will be added to full glass kits, windshields and some back glass orders. These fees are to cover the cost of the protective packaging and will be added to the actual shipping fee:

Windshield / Back Glass	add \$35.00
Complete Glass Sets	add \$60.00

Some other items require more attention when packaging to ensure that you receive them in the best condition possible. These items will incur an additional boxing or crate fee. These fees are to cover the cost of the protective packaging and will be added to the actual shipping fee:

Bed Floor Crate	add \$200.00
Hood Safety Box	add \$45.00



GUARANTEE

Parts Guarantee

All Auto Metal Direct brand products are guaranteed to be free from defects in material and workmanship. We require that you test fit ALL parts before sanding, priming, painting or modifying them in any way. If we deem your part defective, our responsibility is to replace the part, issue credit, or refund the original purchase price. We are not responsible for any paint or labor expenses. The credit or refund amount will not exceed the defective part's original purchase price and may be subjected to being issued as in-store credit.

BACK ORDERS

Back Orders

Any items not available at the time the order is placed will be put on backorder. All backordered items that ship after the original shipment will be subject to additional shipping charges. Backorders will not be shipped without your prior authorization. Please let us know if you do not wish to receive backorders.

RETURNS

Returns

You may return any unused, undamaged, unmodified, and resellable part in its original packaging for exchange, credit or refund for up to 6 months after original purchase date. All orders, cancellations and returns are subject to a 15% restocking fee. **ALL RETURNS MUST HAVE PRIOR AUTHORIZATION BEFORE THEY WILL BE ACCEPTED.** All shipping costs associated with a return are your responsibility. If the return shipment is damaged in transit back to us, it may not be accepted.

MORE PARTS ONLINE

Additional Parts Available

Although this catalog is geared towards the Mopar owner, we do carry a LOT of parts for other makes and models. If you're anything like us, you have several projects that consist of a large variety of vehicles saved from the scrap heap. Be sure to check out our full selection at autometaldirect.com

COPYRIGHT / TRADEMARK

Copyright and Trademark Information

For this catalog, All rights are reserved. No part of this catalog is to be reproduced, copied, or retransmitted in any form or means without direct written consent from Auto Metal Direct. AMD Auto Metal Direct, 'Our Name Says it All' and 'Never Too Far Gone' are registered trademarks of Auto Metal Direct.

© Copyright 2024 Auto Metal Direct, LLC.

Any part indicated MOPAR Authentic Restoration Part are officially manufactured and licensed under the MOPAR Authentic Restoration License Program. Logos, illustrations, images and trademarks of Stellantis are used under license by AMD and our suppliers. Any descriptions bearing trade-marked names are for application reference only.



Any part indicated MOPAR Authentic Restoration Part are officially manufactured and licensed under the MOPAR Authentic Restoration License Program. Logos, illustrations, images and trademarks of Stellantis are used under license by AMD and our suppliers. Any descriptions bearing trade-marked names are for application reference only.



AMD Garage is our show series dedicated to bringing you the best of the best. We offer the latest content from industry leaders, top builders, DIY car enthusiast, car and truck shows, social media influencers, and so much more. Follow us at @autometaldirect on all major social media outlets.



WARNING: Cancer and Reproductive Harm - www.P65Warnings.ca.gov



AUTHENTIC RESTORATION
PRODUCT

WWW.AUTOMETALDIRECT.COM

866.719.9505