

AMP



DODGE • PLYMOUTH B-BODY RESTORATION PARTS



SilentDrivePRO SOUND DAMPENING



AMD's new SilentDrive Pro Mat Sound Deadener offers premium noise reduction with three different versions to suit various needs. Two of the variants feature a 2mm thickness, with one showcasing blue lettering and the other white lettering for aesthetic preferences. For those seeking enhanced sound insulation, a thicker 7mm option is available. Each box includes 10 sheets, covering a total of 43 square feet, making it an excellent solution for reducing vibrations and road noise in vehicles or other applications requiring soundproofing.



403-1000-825B



403-1000-857





B-BODY

Part Numbers Highlighted **BLUE** are Officially Licensed Mopar Authentic Restoration Products



INDEX

Description	Page	Description	Page	Description	Page
Accelerator Pedal	39	Deck Filler	26	Fender, Front	15
Antenna	16	Deck Lid	26	Fender, Inner	15
Armrest	38	Deck Support	30	Filler Neck	50
Ashtray	38	Dome Light	38	Filler Tube	50
Back Glass	44	Door Bumpers	20	Finish Panel	42
Back Glass Molding	40	Door Glass	45	Firewall	17
Back-Up Lamp	48	Door Handles	22	Firewall Gasket	18
Battery Tray	12	Door Hinge	21	Firewall Pad	17
Body Bolt Fastener	51	Door Hinge Bolts	21	Floor Pan	24
Body Bumper	34	Door Hinge Springs	21	Floor Pan Support	23
Body Plugs	34	Door Jamb Pillar	30	Floor Wiring	24
Brake Pedal	39	Door Latch Clip	22	Frame Rail	23
Bumper Bracket, Front	5	Door Lock	38	Fresh Air Vent Seals	18
Bumper Bracket, Rear	7	Door Lock Cylinder	22	Gas Cap	50
Bumper Filler	7	Door Panels	21	Gas Tank	49
Bumper Guards	6	Door Plugs	20	Glove box	38
Bumper Mounting	5	Door Seals	20	Grille	9
Bumper Seals	7	Door Shell	20	Grille Bezel	10
Bumper Shields,	5	Door Sills	37	Grille Hardware	9
Bumper, Front	5	Door Skin	20	Grille Molding	9
Bumper, Rear	7	Door Striker	21	Grille Panel	9
Console	37	Drip Rail Molding	40	Grille Trim	40
Console Bracket	24	Emblems	41	Grille/Headlamp Support	10
Convertible Top	37	Emergency Cable	38	Headlamp	36
Core Support	12	Engine Mount	52	Headlamp Adjuster	11
Corner Filler	26	Exterior Trim	40	Headlamp Bezel	11
Cowl	17	Fender Bolt	16	Headlamp Door	11
Cowl Hinge	17	Fender Brace	15	Headlamp Dust Shields	11
Cowl Hinge Repair	17	Fender Bracket	15	Headlamp Splash Shields	11
C-Pillar	25	Fender Cover	15	Headrest Post	38
C-Pillar Vertical Post	30	Fender Repair	16	Heater Box	18
Crossmember	23	Fender Seals	15	Hood	13
Cylinder Gasket	18	Fender Shock Tower	15	Hood Bolt	14
Dash Panel	38	Fender Splash Shield	15	Hood Bracket	14



INDEX

Description	Page	Description	Page	Description	Page
Hood Bumper	14	Quarter Window	46	Trunk Bumper	31
Hood Cable	14	Radiator	12	Trunk Deck Lid	30
Hood Hinges	14	Radiator Brace	12	Trunk Floor	31
Hood Insulation	14	Radiator Cap	12	Trunk Gutter	31
Hood Latch	14	Radiator Seals	12	Trunk Lock	32
Hood Mounting	14	Radio	38	Trunk Support	30
Hood Pin	14	Rear Window	44	Trunk Trim	42
Hood Scoop	13	Rocker Panel	24	Trunk Weatherstrip	31
Hood Seal	14	Rocker Panel Molding	40	Turn Signal	36
Hood Spring	14	Roof Bow	25	U-Jamb Seals	27
Hood Strap	14	Roof Drip Rails	25	Valance Bolts	19
Ignition Switch	36	Roof Side Rail	25	Valance, Front	19
Ignition & Door Lock	22	Roof Skin	25	Valance, Rear	33
Interior Trim	37	Sail Panel	30	Valve Covers	52
Interior Window	44	Seat Belt	38	Vent Glass	45
Jack Bracket	34	Seat Floor Brackets	24	Vent Line	50
K-Frame	35	Seat Pan	24	Vent Window	45
Leaf Spring Mount	23	Seat V-Brace	24	Vent Window Support	27
Leaf Spring Relocation	35	Shift Boot	38	Vinyl Top Molding	40
License Plate	5	Shifter Tunnel	24	Weatherstrips	25
Master Hardware	51	Shock Tower	23	Weld-In Frame Connectors	35
Mini-Tub	29	Side Marker	47	Wheel Opening Molding	40
Mirrors	36	Spare Tire	34	Wheelhouse	29
Mood Molding	14	Splash Shield	23	Window Crank Handle	21
Oil Filter	52	Steering Column	18	Window Frame	26
Package Tray	26	Steering Mount	17	Window Handle Spacer	21
Paint Gasket	48	Steering Wheel	38	Window Regulator	21
Park Brake	39	Stiffening Kit	35	Window Switch	36
Park Lamp	47	Tail Lamp	33	Windshield	43
Pillar to Cowl Brace	17	Tail Lamp	40	Windshield A-Pillar	25
Power Brake Booster	18	Taillight Molding	40	Windshield Bow	25
Quarter Glass	46	Torque Box	35	Windshield Molding	40
Quarter Panel	27	Trim Retainer	26	Wiper Pivot	43
Quarter Panel Patch	28	Trunk Bolt	32	Wiper Switch	36

FRONT BUMPER



#	YEAR	DESCRIPTION	MODEL	PART #
1	63	Front Bumper	Plymouth B-Body	100-1463
2	64	Front Bumper	Plymouth B-Body	100-1464
3	65	Front Bumper	Plymouth B-Body	100-1465
4	67	Front Bumper	Plymouth B-Body	100-1467
5	68-69	Front Bumper	Plymouth B-Body	100-1468
6	68-69	Front Bumper	Coronet/Super Bee	100-2468
7	70	Front Bumper	Plymouth B-Body	100-1470
8	71	Front Bumper	Plymouth B-Body	100-1471
9	71-72	Front Bumper w/ Jack Slots	Plymouth B-Body	100-1472
10	68-69	Front Bumper Lower Shield	Plymouth B-Body	120-1468
	68-69	Front Bumper Lower Shield	Coronet	120-2468
	70	Front Bumper Lower Shield	Plymouth B-Body	120-1470
11	68-69	Front Bumper Bracket Set	Plymouth B-Body	105-1468-S
12	68-69	Front Bumper Bracket Set	Coronet/Super Bee	105-2468-S
13	70	Front Bumper Bracket Set	Plymouth B-Body	105-1470-S
14	70	Front Bumper Rubber Cushions - Pair (except Superbird)	Plymouth B-Body	F-468-9
	68-74	Bumper Mounting Bolt Set - 16Pcs	All B-Body	101-1000-16S
	68-74	Bumper Mounting Bolt Set - 24Pcs	All B-Body	101-1000-24S
15	68-74	Bumper Mounting Bolt Set - 32Pcs	All B-Body	101-1000-32S
16	64-74	License Plate Screw & Nut	All B-Body	X102-1464

VISIT US ONLINE

 FOR THE MOST

 UP-TO-DATE PRICING

 AND SELECTION



CHARGER FRONT BUMPER



#	YEAR	DESCRIPTION	MODEL	PART #
1	68-69	Front Bumper - w/ Bumperettes - Chrome	Charger	100-2668-1
2	70	Front Bumper	Charger	100-2670
3	71-72	Front Bumper	Charger	100-2671
4	72	Front Bumper - w/ Jack Slots	Charger	100-2672
5	73-74	Front Bumper	Charger	100-2673
6	68-74	Bumper Mounting Bolt Set - 16pcs	All B-Body	101-1000-16S
	68-74	Bumper Mounting Bolt Set - 24Pcs	All B-Body	101-1000-24S
	68-74	Bumper Mounting Bolt Set - 32Pcs	All B-Body	101-1000-32S
7	68-69	Front Bumper Bracket Set	Charger	105-2668-5
8	68-69	Front Bumper Center Bar Bracket	Charger	105-2668-2
9	68-69	Front Bumper Stabilizer Brackets	Charger	106-2668-S
10	68-69	Front Bumper Guards - Pair	Charger	110-2668-P





REAR BUMPER

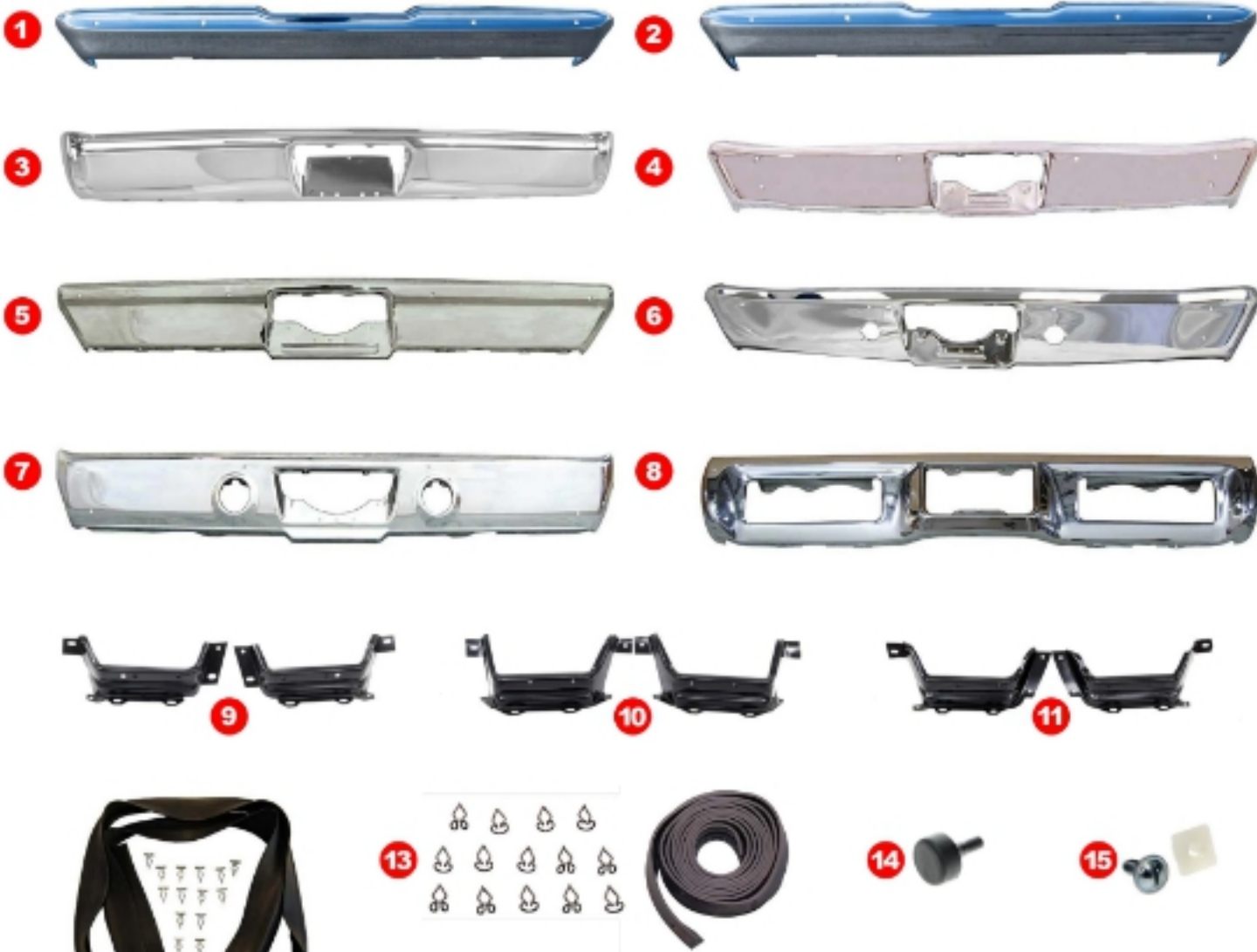

#	YEAR	DESCRIPTION	MODEL	PART #
1	63-65	Rear Bumper	Plymouth B-Body	990-1463
2	64	Rear Bumper	Plymouth B-Body	990-1464
3	66-67	Rear Bumper - (except Wagon)	Plymouth B-Body	990-1466
4	68	Rear Bumper	Plymouth B-Body	990-1468
5	68-69	Rear Bumper	Coronet/Super Bee	990-2468
6	69	Rear Bumper	Plymouth B-Body	990-1469
7	70	Rear Bumper	Plymouth B-Body	990-1470
8	71	Rear Bumper	Plymouth B-Body	990-1471
9	68-69	Rear Bumper Bracket Set	Plymouth B-Body	970-1468-S
10	68-69	Rear Bumper Bracket Set	Coronet/Super Bee	970-2468-S
11	70	Rear Bumper Bracket Set	Plymouth B-Body	970-1470-S
12	66-67	Rear Bumper Filler - (Must be Notched/Punched)	All B-Body	F-967R
13	66-67	Rear Bumper to Body Seal	All B-Body	A-150936
14	64-74	License Plate Bumper	All B-Body	X102-1462
15	64-74	License Plate Screw & Nut	All B-Body	X102-1464

VISIT US ONLINE

 FOR THE MOST

 UP-TO-DATE PRICING

 AND SELECTION



CHARGER REAR BUMPER



#	YEAR	DESCRIPTION	MODEL	PART #
1	68-70	Rear Bumper - w/ Bumperettes - Chrome	Charger	990-2668-1
2	71	Rear Bumper	Charger	990-2671
3	72	Rear Bumper	Charger	990-2672
4	73-74	Rear Bumper	Charger	990-2673
5	68-70	Rear Bumper Bracket Set	Charger	970-2668-S
6	68-70	Rear Bumper Guards	Charger	980-2668-P
7	68-70	Rear Bumper Guard Brackets	Charger	981-2668-P



VISIT US ONLINE
FOR THE MOST
UP-TO-DATE PRICING
AND SELECTION



WARNING: Cancer and Reproductive
Harm - www.P65Warnings.ca.gov



**AUTHENTIC
RESTORATION**
MARKET

WWW.AUTOMETALDIRECT.COM

866.719.9505



B-BODY

Part Numbers Highlighted **BLUE** are Officially Licensed Mopar Authentic Restoration Products



PLYMOUTH GRILLE

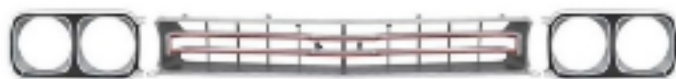

1



2



3



4



5



6



7



8



9



10

11



12



#	YEAR	DESCRIPTION	MODEL	PART #
1	69	Grille Assembly - w/ Headlamp Bezels	Sport Satellite/GTX	X150-1469-15
2	69	Grille Assembly - w/ Headlamp Bezels	Belvedere/Satellite/Road Runner	K-MB2169
3	70	Grille Assembly - w/ Headlamp Bezels	Belvedere/Satellite/Road Runner	K-RM4130
4	70	Grille Assembly - w/ Headlamp Bezels	Sport Satellite/GTX	K-RM4131
5	69	Grille - Center	Belvedere/Satellite/Road Runner	K-2947007
6	70	Grille - Center w/ Moldings - (except Superbird)	Belvedere/Satellite/Road Runner	X150-1470
7	70	Grille - Center w/ Moldings	Sport Satellite/GTX	X150-1470-1
8	68-69	Lower Grille Panel	Plymouth B-Body	130-1468
9	70	Lower Grille Panel - (except Superbird)	Plymouth B-Body	X150-1470-2
10	70	Lower Grille Molding - (except Superbird)	Plymouth B-Body	X155-1470
11	66	Grille Hardware Set	Satellite	A-271151
	67	Grille Hardware Set	Coronet R/T	A-271150
	67	Grille Hardware Set	Plymouth B-Body	A-271152
	68	Grille Hardware Set - (except Sport Satellite/GTX)	Plymouth B-Body	A-271153
	68	Grille Hardware Set	Coronet/Super Bee	A-271154
	68	Grille Hardware Set	Sport Satellite/GTX	A-271155
	69	Grille Hardware Set	Coronet/Super Bee	A-271157
	69	Grille Hardware Set - (except Sport Satellite/GTX)	Plymouth B-Body	A-271158
	69	Grille Hardware Set	Sport Satellite/GTX	A-271159
	70	Grille Hardware Set - (except Superbird)	Plymouth B-Body	A-271160
	70	Grille Hardware Set	Coronet/Super Bee	A-271162
12	66-70	Lower Grille / Filler Panel Bolt Set - (except Charger)	All B-Body	X151-1466-S



VISIT US ONLINE FOR THE MOST UP-TO-DATE PRICING AND SELECTION



DODGE GRILLE



1



2



3



4



5



6



7



8



9



10

#	YEAR	DESCRIPTION	MODEL	PART #
1	70	Grille Assembly	Charger	K-2998440
2	70	Grille Assembly w/ Headlamp Doors	Charger	K-MB9912
3	71	Grille - LH - Black/Silver	Charger Super Bee or R/T	K-3442379
	71	Grille - RH - Blado/Silver	Charger Super Bee or R/T	K-3442378
	71	Grille - LH - Silver	Charger Base or 500	K-3442895
	71	Grille - RH - Silver	Charger Base or 500	K-3442894
4	69	Grille Set - Economy Style - Silver - (except Daytona or 500)	Charger	X150-2669-1S
	69	Grille Set - Economy Style - Black - (except Daytona or 500)	Charger	X150-2669-2S
5	68-69	Grille - Center - Black	Coronet R/T, Charger 500	X150-2668
6	69	Grille - Center - Silver - (except Daytona or 500)	Charger	X150-2669
7	68-69	Grille / Headlamp Support - OE Style	Charger	151-2668
8	68-69	Grille Extension Bezel w/ Brackets - LH - (except 69 Daytona or 500)	Charger	X150-2668-L
	68-69	Grille Extension Bezel w/ Brackets - RH - (except 69 Daytona or 500)	Charger	X150-2668-R
9	69	Center Grille "I" Trim - Chrome - (except 500 or Daytona)	Charger	X155-2669-1
10	68-69	Grille Hardware Set - (except Daytona or 500)	Charger	A-271156
	70	Grille Hardware Set	Charger	A-271161



VISIT US ONLINE FOR THE MOST UP-TO-DATE PRICING AND SELECTION



WARNING: Cancer and Reproductive Harm - www.P65Warnings.ca.gov



AUTHENTIC RESTORATION

WWW.AUTOMETALDIRECT.COM

866.719.9505

10



HEADLIGHT



#	YEAR	DESCRIPTION	MODEL	PART #
1	69	Headlamp Bezel - LH	Road Runner	K-2949247
	69	Headlamp Bezel - RH	Road Runner	K-2949246
	69	Headlamp Bezels - Pair	Sport Satellite/GTX	X145-1469-2P
2	70	Headlamp Bezel - LH	Road Runner	K-2998013
	70	Headlamp Bezel - RH	Road Runner	K-2998012
	70	Headlamp Bezel - LH	Sport Satellite/GTX	X145-1470-1L
3	70	Headlamp Bezel - RH	Sport Satellite/GTX	X145-1470-1R
	71	Headlamp Bezels - Pair	Satellite/GTX/RR	X145-1471-3P
	4	70	Headlamp Door Assembly w/ Texture - LH	Charger
70		Headlamp Door Assembly w/ Texture - RH	Charger	K-2998550
5	69	Headlamp Door - LH - (except Daytona or 500)	Charger	X145-2669-L
	69	Headlamp Door - RH - (except Daytona or 500)	Charger	X145-2669-R
6	68-69	Headlamp Door Actuator Rods - Pair - (except Daytona)	Charger	151-2668-2P
	7	68-69	Headlamp Door Actuator Bracket - LH or RH - (except Daytona)	Charger
8	70-72	Headlamp Door Bumper Set - 4pcs	Charger	K-2785824
	9	70	Headlamp Door Crank Rod	Charger
10	71	Headlamp Dust Shields	Plymouth B-Body	A-150945
	11	73-74	Headlamp Splash Shields	Plymouth B-Body
73-74		Headlamp Splash Shields	Charger	A-150913
12	66-67	Headlamp Adjuster Set - 2 Headlights	All B-Body	A-280524
	66-67	Headlamp Adjuster Set - 4 Headlights	All B-Body	A-280525
	72-76	Headlamp Adjuster Set - 2 Headlights	All B-Body	X142-1072-2S
	68-71	Headlamp Adjuster Set - 4 Headlights	All B-Body	X142-1468-4S
13	72-78	Headlamp Adjuster Set - 4 Headlights	All B-Body	X142-1472-4S
	70	Headlamp Door Hardware Set - 12pcs	Charger	K-MB1919
14	71	Headlamp Shield Nut Set - 36pcs	Charger	X145-2471-1S

VISIT US ONLINE

 FOR THE MOST

 UP-TO-DATE PRICING

 AND SELECTION



Part Numbers Highlighted **BLUE** are Officially Licensed Mopar Authentic Restoration Products



CORE SUPPORT



#	YEAR	DESCRIPTION	MODEL	PART #
1	66-68	Radiator Support - Upper	All B-Body	350-1466
	69	Radiator Support - Upper	All B-Body	350-1469
2	71-72	Radiator Support - Upper	All B-Body	350-1570
3	66-70	Radiator Support - Lower	All B-Body	351-1466
4	71-72	Radiator Support - Lower	All B-Body	351-1570
5	66-70	Core Support Stiffener	All B-Body	X349-1466-1
6	73-74	Radiator Seals	Charger	A-150946
7	71-74	Hood to Radiator Seal Clip Set - 11pcs	All B-Body	F-489-11
8	66-67	Front Lower Shield Below Radiator	All B-Body	F-784S
9	60-66	Radiator Cap - OE Style - Chrome - 14#	All B-Body	X357-1060-C
	60-66	Radiator Cap - OE Style - Zinc - 14#	All B-Body	X357-1060-Z
	64-69	Radiator Cap - Zinc - Small Rivet 16#	All B-Body	F-107
	67-70	Radiator Cap - OE Style - Zinc - Loose Font - 16#	All B-Body	X357-1067-Z
	70-74	Radiator Cap - OE Style - Zinc - Tight Font - 16#	All B-Body	X357-1070-Z
10	66-70	K-Member to Radiator Support Brace	All B-Body	352-1466



BATTERY TRAY



#	YEAR	DESCRIPTION	MODEL	PART #
1	62-65	Battery Tray - w/ Brace	All B-Body	340-1462
2	66-69	Battery Tray - w/ "S" Braces	All B-Body	340-1466
3	70-72	Battery Tray	All B-Body	340-1570
4	73-74	Battery Tray	All B-Body	340-1473
5	62-65	Battery Hold Down Clamp	All B-Body	341-1462-1
6	66-69	Battery Hold Down Kit	All B-Body	X341-1466-1
	70-71	Battery Hold Down Kit	All B-Body	X341-1370-1
	72-74	Battery Hold Down Kit	All B-Body	X341-1472-5
7	67-70	Battery Tray Brace Set - 3pcs	All B-Body	A-100130
	66-70	Battery Tray S Brace	All B-Body	A-100126
	66-70	Battery Tray Brace - Upper Long	All B-Body	A-100127
8	71	Battery Tray Brace	All B-Body	X341-1570-2
9	66-72	Battery Hold Down J-bolt - 7"	All B-Body	F-814
	66-72	Battery Hold Down J-bolt - 8.5"	All B-Body	F-89



VISIT US ONLINE
FOR THE MOST
UP-TO-DATE PRICING
AND SELECTION



WARNING: Cancer and Reproductive
Harm - www.P65Warnings.ca.gov



**AUTHENTIC
RESTORATION**
PRODUCT

WWW.AUTOMETALDIRECT.COM

866.719.9505



B-BODY

Part Numbers Highlighted **BLUE** are Officially Licensed Mopar Authentic Restoration Products



HOOD

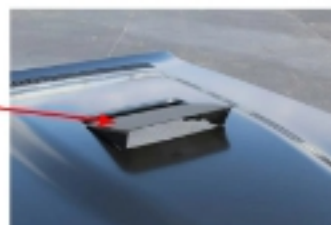
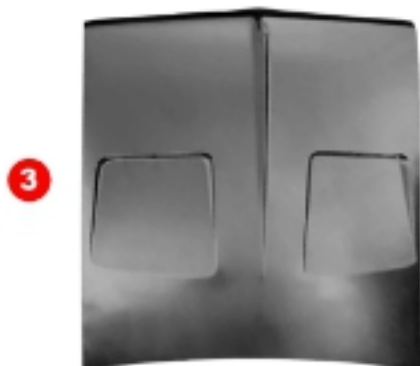

8

9

#	YEAR	DESCRIPTION	MODEL	PART #
1	68	Hood - OE Style - 2 Latch Locations	Road Runner/GTX	300-1468-A
2	68-69	Hood - OE Style	Road Runner/GTX	300-1468
3	68-69	Hood - OE Style - (except 69 Daytona)	Charger	300-2668
4	70	Hood - Standard w/o Hood Pin Holes	Belvedere/GTX/Road Runner/Satellite	300-1470-1
5	70	Hood - Fresh Air w/o Hood Pin Holes	Belvedere/GTX/Road Runner/Satellite	300-1470-2
6	71-74	Hood - Rallye / Power Bulge	Charger	300-2671-1
7	71-74	Hood - Ramcharger	Charger	300-2671-2
8	67	Hood Scoop	GTX	X320-1467-P
9	70-74	Hood Scoop - Air Grabber / Ramcharger	Belvedere/GTX/Road Runner/Satellite	301-1470



VISIT US ONLINE FOR THE MOST UP-TO-DATE PRICING AND SELECTION



Part Numbers Highlighted **BLUE** are Officially Licensed Mopar Authentic Restoration Products

HOOD



1



2



3



4



5



6



7



8



9



10



11



12



13



14



15



16



17

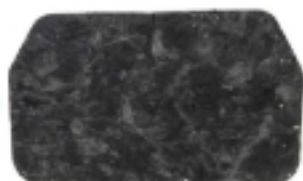

18



20



19



#	YEAR	DESCRIPTION	MODEL	PART #
1	69-70	Air Grabber Mounting Bolt Set	Road Runner/GTX/SuperBee/Coronet R/T	A-270765
	70-72	Air Grabber Mounting Bolt Set	Road Runner/GTX/Charger/SuperBee	A-270766
2	67	Hood Latch - 67 Coronet	Coronet	K-2802432
3	66-70	Hood Hinges - Pair - (66-67 Require Mods)	All B-Body	310-1468-P
	71-74	Hood Hinges - Pair	All B-Body	310-1570-PK
4	66-76	Hood Stop / Bumper - 1.25" Diameter	All B-Body	A-150000
	66-76	Hood Stop / Bumper - 1.00" Diameter	All B-Body	A-151005
5	67	Hood Lip Molding Screw Kit	Plymouth B-Body	A-270285
6	66-67	Hood Pop-up Spring - (except Charger)	All B-Body	F-974
	66-67	Hood Pop-up Spring	Charger	F-974A
	68-70	Hood Pop-up Spring - (70 Plymouth only)	All B-Body	F-730
	70-74	Hood Pop-up Spring - (70 Charger only)	Plymouth B-Body/Charger	F-375
7	66-67	Hood Side Bumper	All B-Body	F-588
	68-70	Hood Side Bumper	All B-Body	F-236
	68-70	Hood Side Bumper - Front	Charger	F-597
8	62-70	Hood Rear Bumper	All B-Body	F-749
9	68-70	Hood Bumper Set	All B-Body	F-HBK03
	71-74	Hood Bumper Set - (except Charger)	All B-Body	F-HBK07
	71-74	Hood Bumper Set	Charger	F-HBK08
10	64-70	Hood Adjustment Bumper Set - 2pcs	Dodge B-Body	J-CH1010
11	69	Lift Off Hood Brackets	All B-Body	X313-1469-1S
12	69&71-74	Hood Pin Cables - 25" - Pair	All B-Body	F-HPC25
	70	Hood Pin Cables - 23" - Pair	All B-Body	F-HPC23
13	69&71-74	Hood Pin Set - w/ 25" Cables	All B-Body	F-HPS25
	70	Hood Pin Set - w/ 23" Cables	All B-Body	F-HPS23
14	66-70	Under Hood Strap Set	All B-Body	F-USK02
	71-72	Under Hood Strap Set	All B-Body	F-USK04
	73-74	Under Hood Strap Set	All B-Body	F-USK06
15	66-67	Under Hood Seal Clip	All B-Body	F-904
16	68-69	Under Hood Bolt Set	All B-Body	X354-1468-1S
	70	Under Hood Bolt Set	All B-Body	A-270706
17	66-70	Hood Bolt Set	All B-Body	X312-1466-1S
18	70	Hood Insulation - w/ Clips	All B-Body	J-CH2060
19	72-74	Hood Insulation Plastic Clip Kit	All B-Body	J-CH2069
20	66-70	Hood to Cowl Seal - w/ Clips	All B-Body	J-CH2077
	66-70	Hood to Cowl Seal - w/ Clips Installed	All B-Body	J-CH2011



VISIT US ONLINE FOR THE MOST UP-TO-DATE PRICING AND SELECTION



WARNING: Cancer and Reproductive Harm - www.P65Warnings.ca.gov



AUTHENTIC RESTORATION

WWW.AUTOMETALDIRECT.COM

866.719.9505



B-BODY

Part Numbers Highlighted **BLUE** are Officially Licensed Mopar Authentic Restoration Products



FENDER

B-BODY FENDER

CHARGER FENDER



#	YEAR	DESCRIPTION	MODEL	PART #
1	68	Front Fender - LH	Plymouth B-Body	200-1468-L
	68	Front Fender - RH	Plymouth B-Body	200-1468-R
2	68	Front Fender - LH	Charger	200-2668-L
	68	Front Fender - RH	Charger	200-2668-R
3	69	Front Fender - LH	Plymouth B-Body	200-1469-L
	69	Front Fender - RH	Plymouth B-Body	200-1469-R
4	69	Front Fender - LH	Charger	200-2669-L
	69	Front Fender - RH	Charger	200-2669-R
5	66-70	Inner Fender - LH	All B-Body	250-1466-L
	66-70	Inner Fender - RH	All B-Body	250-1466-R
6	71	Inner Fender - LH	All B-Body	250-1570-L
	71	Inner Fender - RH	All B-Body	250-1570-R
7	72	Inner Fender - LH	All B-Body	250-1572-L
	72	Inner Fender - RH	All B-Body	250-1572-R
8	68-69	Front Fender Brace - LH or RH - (except Charger)	Plymouth B-Body	220-1468
9	66-72	Front Shock Tower - LH	All B-Body	249-1466-L
	66-72	Front Shock Tower - RH	All B-Body	249-1466-R
10	66-70	Shock Tower to Inner Fender Brace Set - 2pcs	All B-Body	253-1466-1P
11	66-70	Inner Fender Cover Plates - Pair	All B-Body	255-1466-PK
12	66-70	Inner Fender to Cowl Bracket - Lower - LH	All B-Body	260-1466-1L
	66-70	Inner Fender to Cowl Bracket - Lower - RH	All B-Body	260-1466-1R
13	66-70	Inner Fender to Cowl Bracket - Upper - LH	All B-Body	260-1466-L
	66-70	Inner Fender to Cowl Bracket - Upper - RH	All B-Body	260-1466-R
14	68-69	Front Inner Fender Splash Shields - Pair	Charger	353-2668-S
15	68-70	Rear Splash Plate Rubber Shield Set w/ Clips - 4pcs	All B-Body	F-FSR02G
16	68-70	Fender Splash Shields - Pair	Plymouth B-Body	251-1468-PK
	68-70	Fender Splash Shields - Pair	Charger/Coronet/Superbird	251-2468-PK
17	68-70	Fender To Body Seals	All B-Body	A-150925



VISIT US ONLINE FOR THE MOST UP-TO-DATE PRICING AND SELECTION



Part Numbers Highlighted **BLUE** are Officially Licensed Mopar Authentic Restoration Products

FENDER



1

- 1. Inner Fender Hardware (28pcs)
- 2. Fender to Core Support Hardware (18pcs)
- 3. Fender to Cowl Hardware (8pcs)
- 4. Fender to Lower Rocker Hardware (12pcs)
- 5. Fender to Bumper Brackets (Round Rod) Brace Hardware (6pcs)
- 6. Hood Hinge & Hood Bolts (4 shorter) (10pcs)



2



3



4



5



6



7

8

9

#	YEAR	DESCRIPTION	MODEL	PART #
1	66-67	Fender Bolt Kit	All B-Body	X203-1466-S
	68-70	Fender Bolt Kit	All B-Body	X203-1468-S
2	66-70	Inner Fender Brace Kit	All B-Body	X253-1466-S
3	62-65	Inner Fender Cover - LH	All B-Body	255-1462-L
	62-65	Inner Fender Cover - RH	All B-Body	255-1462-R
4	66-67	Fender Splash Shield Seals w/ Clips - Front	Dodge B-Body	F-FSF2
	68-69	Fender Splash Shield Seals w/ Clips - Front	Plymouth B-Body	F-FSF3
	68-69	Fender Splash Shield Seals w/ Clips - Front	Charger	F-FSF5
	70	Fender Splash Shield Seals w/ Clips - Front	Plymouth B-Body	F-FSF6
	70	Fender Splash Shield Seals w/ Clips - Front	Charger	F-FSF8
	71-72	Fender Splash Shield Seals w/ Clips - Front	Plymouth B-Body	F-FSF15
5	66-67	Fender Splash Shield Seals - Rear - 4pcs	All B-Body	F-SR1
	68-70	Fender Splash Shield Seals - Rear - 4pcs	All B-Body	F-SR2
6	73-74	Front Fender to Inner Fender Splash Shields	All B-Body	A-150934
7	68-70	Front Fender Lower Rear Repair Panel w/ Brace - LH	Plymouth B-Body	205-1468-L
	68-70	Front Fender Lower Rear Repair Panel w/ Brace - RH	Plymouth B-Body	205-1468-R
8	68-70	Front Fender Lower Rear Repair Panel w/ Brace - LH	Charger	205-2668-L
	68-70	Front Fender Lower Rear Repair Panel w/ Brace - RH	Charger	205-2668-R
9	71-72	Front Fender Lower Rear Repair Panel w/ Brace - LH	Plymouth B-Body	205-1471-L
	71-72	Front Fender Lower Rear Repair Panel w/ Brace - RH	Plymouth B-Body	205-1471-R

ANTENNA

1

2



3



4



5



6

#	YEAR	DESCRIPTION	MODEL	PART #
1	68-70	Antenna Assembly - (except Charger)	All B-Body	S-PB7
	66-67	Antenna Assembly	All B-Body	X280-1466-S
	68-70	Antenna Assembly	All B-Body	X280-2668
2	65-74	Antenna Mast - 3 Stage - 60"	All B-Body	F-658A
3	65-67	Antenna Nut - Small	All B-Body	F-918
	68-74	Antenna Nut - Large	All B-Body	F-875
4	65-67	Antenna Adapter	All B-Body	F-977
	68-70	Antenna Adapter	Charger	F-925B
5	66-70	Antenna Bezel / Adapter - (except Charger)	All B-Body	F-924
6	68-76	Antenna Gasket	All B-Body	J-CH1025



VISIT US ONLINE FOR THE MOST UP-TO-DATE PRICING AND SELECTION





B-BODY

Part Numbers Highlighted **BLUE** are Officially Licensed Mopar Authentic Restoration Products



COWL/FIREWALLS



#	YEAR	DESCRIPTION	MODEL	PART #
1	66-70	Firewall - w/o AC	All B-Body	370-1466
2	66-70	Cowl Plenum - Lower	All B-Body	360-1466-1
3	66-70	Cowl Panel - Upper	All B-Body	360-1466
4	66-70	Cowl Side Hinge Panel - Inner - LH	All B-Body	376-1466-2L
	66-70	Cowl Side Hinge Panel - Inner - RH	All B-Body	376-1466-2R
5	66-70	Cowl Side Door Hinge Repair Panel - Outer - LH	All B-Body	376-1466-1L
	66-70	Cowl Side Door Hinge Repair Panel - Outer - RH	All B-Body	376-1466-1R
6	68-74	Firewall Clutch Rod Plug	All B-Body	A-280157
7	68-70	Pillar to Cowl Brace - Inner - LH	All B-Body	360-1466-3L
	68-70	Pillar to Cowl Brace - Inner - RH	All B-Body	360-1466-3R
8	68-70	Steering Column Mount	All B-Body	458-1468-4
9	66-70	Firewall Pad - w/o AC	All B-Body	A-151063
	66-70	Firewall Pad - w/ AC	All B-Body	A-151064
10	71-74	Firewall Pad - w/o AC	All B-Body	A-151069



VISIT US ONLINE
FOR THE MOST
UP-TO-DATE PRICING
AND SELECTION



COWL/FIREWALLS



1



2



3



4



5



6



7



8

#	YEAR	DESCRIPTION	MODEL	PART #
1	66-70	Firewall Gasket Set - w/o AC - w/ Wiper Pivots	All B-Body	F-FG0
	66-70	Firewall Gasket Set - w/ AC - w/ Wiper Pivots	All B-Body	F-FG1B
2	67-70	Heater Box Seal Set - w/o AC	All B-Body	A-151091
	71-74	Heater Box Seal Set	All B-Body	A-151093
3	71-74	Heater Box to Cowl Seal - RH	All B-Body	A-150963
4	66-70	Heater Box Screw Set	All B-Body	A-270281
5	66-70	Fresh Air Vent to Cowl Seal - w/o AC	All B-Body	A-151030
	71-74	Fresh Air Vent to Cowl Seal - w/o AC	All B-Body	A-150964
6	66-70	Power Brake Booster to Firewall Gasket	All B-Body	J-CH1053
7	66-70	Master Cylinder Gasket - Standard & Power Brake	All B-Body	J-CH1054
8	66-70	Steering Column to Firewall Seal	All B-Body	X361-1466-8



VISIT US ONLINE FOR THE MOST UP-TO-DATE PRICING AND SELECTION



WARNING: Cancer and Reproductive Harm - www.P65Warnings.ca.gov



AUTHENTIC RESTORATION

WWW.AUTOMETALDIRECT.COM

866.719.9505



FRONT VALANCE



1



2



3



4



5



6



#	YEAR	DESCRIPTION	MODEL	PART #
1	68-69	Front Valance	Charger	125-2668
2	70	Front Valance	Charger	125-2670
3	71-72	Front Valance	Plymouth B-Body	125-1471
4	71-72	Front Valance	Charger	125-2671
5	73-74	Front Valance	Charger	125-2673
6	68-69	Front Valance Bolt Set - (except 69 Daytona)	Charger	X128-2668-S
	70	Front Valance Bolt Set	Dodge B-Body	A-270801
	71	Front Valance Bolt Set	Plymouth B-Body	A-270804
	71	Front Valance Bolt Set	Charger	A-270803

DOOR



1



2



3



4



5



6



7



8



9

#	YEAR	DESCRIPTION	MODEL	PART #
1	68	Door Shell - LH - (except Charger)	All B-Body	500-1468-L
	68	Door Shell - RH - (except Charger)	All B-Body	500-1468-R
2	68	Door Shell - LH	Charger	500-2668-L
	68	Door Shell - RH	Charger	500-2668-R
3	69-70	Door Shell - LH - (except Charger)	All B-Body	500-1469-L
	69-70	Door Shell - RH - (except Charger)	All B-Body	500-1469-R
4	69-70	Door Shell - LH	Charger	500-2669-L
	69-70	Door Shell - RH	Charger	500-2669-R
5	68-70	Door Skin - LH - (except Charger)	All B-Body	510-1468-L
	68-70	Door Skin - RH - (except Charger)	All B-Body	510-1468-R
6	68-70	Door Skin - LH	Charger	510-2668-L
	68-70	Door Skin - RH	Charger	510-2668-R
7	66-67	Door End Seals - Pair	All B-Body	A-150205
	68-70	Door Lock Pillar Seals - Pair	All B-Body	F-474-5
8	68-74	Door Frame Plug Kit	All B-Body	A-280154
9	67-70	Door Bumpers - Rounded - Pair	All B-Body	J-CH1007



VISIT US ONLINE
FOR THE MOST
UP-TO-DATE PRICING
AND SELECTION





DOOR

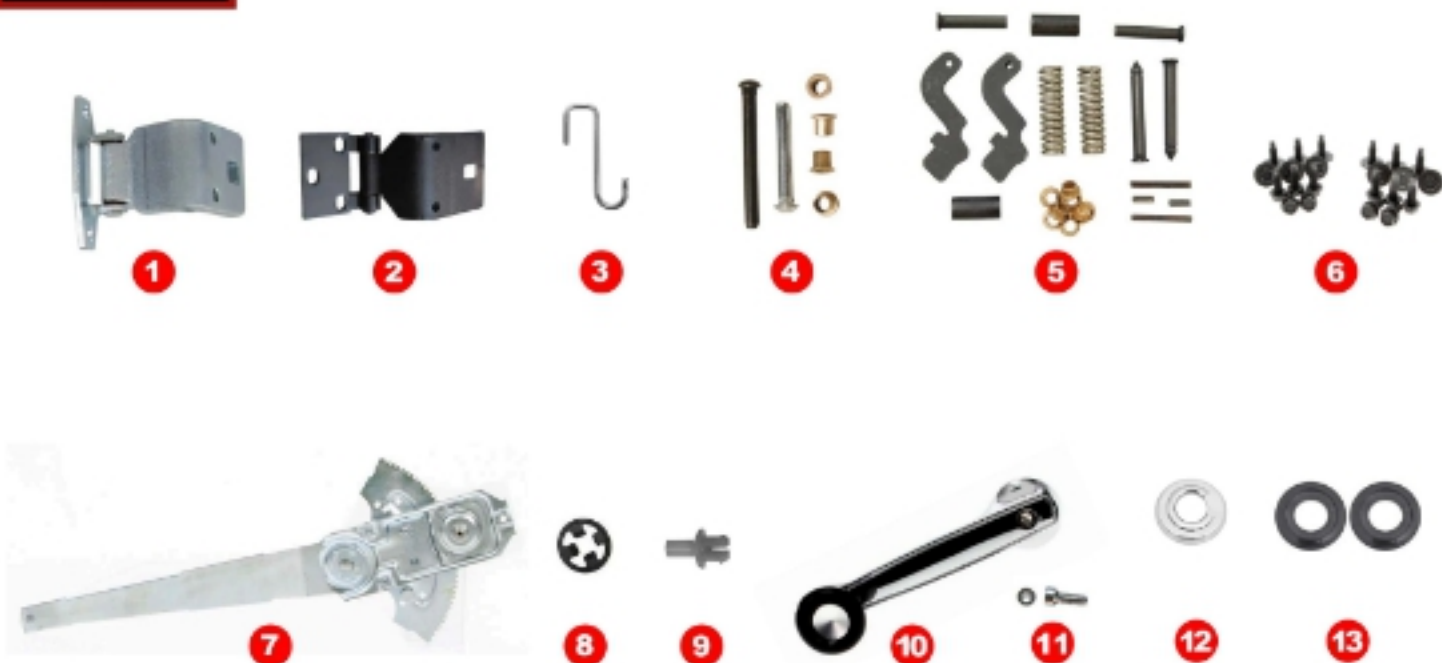

#	YEAR	DESCRIPTION	MODEL	PART #	
1	66-70	Door Hinge - Upper - LH	All B-Body	520-1466-L	
	66-70	Door Hinge - Upper - RH	All B-Body	520-1466-R	
	71-74	Door Hinge - Upper - LH	All B-Body	520-1471-L	
	71-74	Door Hinge - Upper - RH	All B-Body	520-1471-R	
	2	62-65	Door Hinge - Lower - LH	All B-Body	525-1462-L
		62-65	Door Hinge - Lower - RH	All B-Body	525-1462-R
66-70		Door Hinge - Lower - LH	All B-Body	525-1466-L	
66-70		Door Hinge - Lower - RH	All B-Body	525-1466-R	
71-74		Door Hinge - Lower - LH	All B-Body	525-1471-L	
71-74		Door Hinge - Lower - RH	All B-Body	525-1471-R	
3	66-74	Door Hinge Detent Spring - Lower	All B-Body	520-1000	
4	66-74	Door Hinge Pin Set - LH or RH	All B-Body	X521-1000-S	
5	71-74	Door Hinge Pin Set - Pair	All B-Body	A-280035	
6	66-74	Door Hinge Bolt Set - Upper & Lower	All B-Body	X521-1066-S	
7	66-70	Door Window Regulator - LH - (except 66 Charger)	All B-Body	545-1466-L	
	66-70	Door Window Regulator - RH - (except 66 Charger)	All B-Body	545-1466-R	
8	68-74	Door Window Regulator Arm Clip	All B-Body	A-270006	
9	66-72	Door Window Regulator Rivet	All B-Body	A-RIVET	
10	68-76	Door Window Crank Handle w/ Black Knob	All B-Body	X546-1068	
11	68-76	Door Window Crank Handle Screw	All B-Body	X546-1068-3	
12	66-67	Door Window Handle Spacer - Chrome	Charger	K-MB1473	
13	68-74	Door Window Handle Spacers - Pair	All B-Body	K-MD35231	
14	70-76	Door Striker	All B-Body	K-ME8152	
15	68-70	Door Striker Plates w/ Screws - Pair	All B-Body	X752-1468-P	
16	68-70	Door Striker Plate Shim - .60mm	All B-Body	X752-1468-1	
	68-70	Door Striker Plate Shim - 1.5mm	All B-Body	X752-1468-2	
17	62-76	Door Panel Installation Clip	All B-Body	A-270515	



VISIT US ONLINE FOR THE MOST UP-TO-DATE PRICING AND SELECTION



DOOR



VISIT US ONLINE
FOR THE MOST
UP-TO-DATE PRICING
AND SELECTION



#	YEAR	DESCRIPTION	MODEL	PART #
1	66-67	Door Handle Assemblies - Outside - Black Buttons - Pair	All B-Body	T-MP5211
2	66-67	Door Handle Assemblies - Outside - Chrome Buttons - Pair	All B-Body	MP5210
3	68-70	Door Handle Assemblies - Outside - Ball Facing; LH Forward RH Rearward	All B-Body	T-MP5231
	68-70	Door Handle Assemblies - Outside - Ball Facing; Both Frontward - Pair	All B-Body	T-MP5234
	68-70	Door Handle Assemblies - Outside - Ball Facing; Both Rearward - Pair	All B-Body	T-MP5233
4	71-72	Door Handle Assemblies - Outside - Pair	All B-Body	CHBHDL712
	73-74	Door Handle Assemblies - Outside - Pair	All B-Body	T-MP5245
5	68-70	Door Handle - Outside - Ball Facing Forward	All B-Body	X530-1067-L
	68-70	Door Handle - Outside - Ball Facing Forward	All B-Body	X530-1067-R
	71-72	Door Handle - Outside - LH or RH	All B-Body	X530-1471
	73-74	Door Handle - Outside - LH or RH	All B-Body	X530-1473
6	66-67	Door Handle Push Button Kit - Chrome - Outside	All B-Body	T-MP5212
	66-67	Door Handle Push Button Kit - Black - Outside	All B-Body	T-MP5213
7	66-67	Door Handle & Lock Gasket Set	All B-Body	A-151002
	68-70	Door Handle & Lock Gasket Set	All B-Body	A-151001
8	66-70	Door Handles - Inside - Pair	All B-Body	K-MD2145
	71-74	Door Handles - Inside - Pair	All B-Body	K-MD9167
9	66-67	Door Latch / Lock Clip Set	All B-Body	A-270500
	68-70	Door Latch / Lock Clip Set	All B-Body	A-270501
10	68-74	Door Rod Lock Clip	All B-Body	A-270004
11	64-66	Door Handle Rod Clip - Outside	All B-Body	A-270026
12	66-68	Ignition & Door Lock Kit - w/o Illumination	All B-Body	A-280547
	70-71	Ignition & Door Lock Kit - w/o Illumination	All B-Body	A-280548
	72-74	Ignition & Door Lock Kit - w/o Tilt - w/o Telescoping	All B-Body	A-280550
13	68-72	Door Lock Rod Clip - LH	All B-Body	A-270023
	68-72	Door Lock Rod Clip - RH	All B-Body	A-270024
14	68-74	Door Lock Cylinder Retainer Clip	All B-Body	A-280540
15	64-74	Door Lock Knobs - Chrome - Pair	All B-Body	X536-1464-1C
16	64-74	Door Lock Knobs - Black - Pair	All B-Body	A-180119
17	68-70	Door Lock Knob Escutcheons - Pair - (except Charger)	All B-Body	F-1602005
18	68-70	Door Lock Ferrules - Pair	Charger	F-1602006

CHASSIS

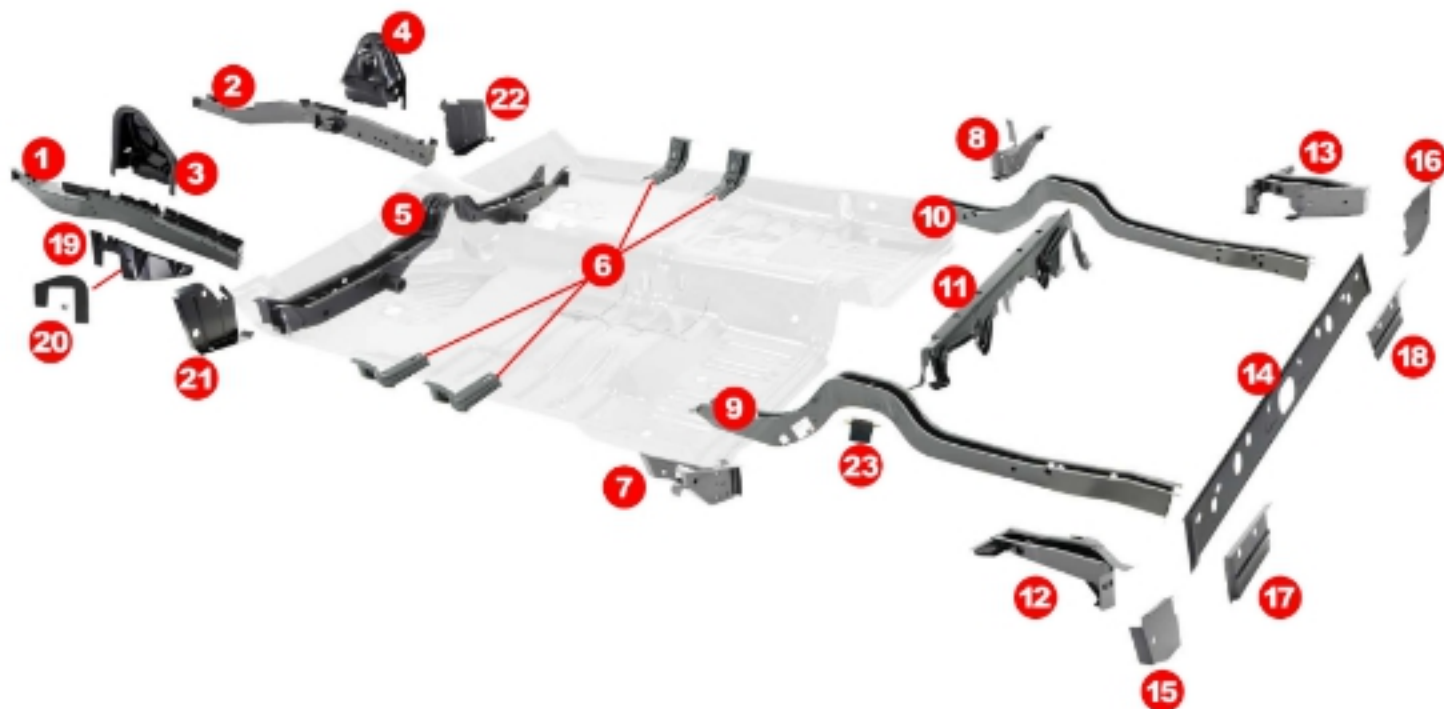

#	YEAR	DESCRIPTION	MODEL	PART #
1	66-70	Front Frame Rail - LH	All B-Body	391-1466-L
2	66-70	Front Frame Rail - RH	All B-Body	391-1466-R
3	66-72	Front Shock Tower - LH	All B-Body	249-1466-L
4	66-72	Front Shock Tower - RH	All B-Body	249-1466-R
5	66-70	Torsion Bar Crossmember	All B-Body	395-1466
	71-72	Torsion Bar Crossmember - (71-74 Requires Modification)	All B-Body	395-1570
6	66-70	Main Floor Pan Support Set - 4pcs	All B-Body	425-1466-S
	71-74	Main Floor Pan Support Set - 4pcs	All B-Body	425-1570-S
7	66-70	Leaf Spring Mount - Front - LH	All B-Body	865-1466-1L
8	66-70	Leaf Spring Mount - Front - RH	All B-Body	865-1466-1R
9	68-70	Rear Frame Rail - LH	All B-Body	895-2468-L
10	68-70	Rear Frame Rail - RH	All B-Body	895-2468-R
11	66-70	Upper Rear Crossmember / Shock Mount	All B-Body	860-1466
12	66-70	Leaf Spring Mount - Rear - LH	Plymouth B-Body	865-1466-2L
	66-70	Leaf Spring Mount - Rear - LH	Dodge B-Body	865-2466-2L
13	66-70	Leaf Spring Mount - Rear - RH	Plymouth B-Body	865-1466-2R
	66-70	Leaf Spring Mount - Rear - RH	Dodge B-Body	865-2466-2R
14	68-70	Rear Crossmember	All B-Body	870-1468
15	68-70	Rear Crossmember Extension - LH - (except Charger)	All B-Body	871-1468-1L
16	68-70	Rear Crossmember Extension - RH - (except Charger)	All B-Body	871-1468-1R
17	68-70	Rear Crossmember Reinforcement - LH - (except Charger)	All B-Body	871-1468-2L
18	68-70	Rear Crossmember Reinforcement - RH - (except Charger)	All B-Body	871-1468-2R
19	66-70	Starter Splash Shield		387-1466
20	68-70	Frame Splash Shield	All B-Body	A-150926
21	66-70	Rocker To Frame Lower Splash Shield - LH	All B-Body	437-1468-L
22	66-70	Rocker To Frame Lower Splash Shield - RH	All B-Body	437-1468-R
23	71-72	Frame Rail Bumpers - 2 1/2" Triangular - Pair	All B-Body	F-841
	71-72	Frame Rail Bumpers - 2" Triangular - Pair	All B-Body	F-843



VISIT US ONLINE
FOR THE MOST
UP-TO-DATE PRICING
AND SELECTION



Part Numbers Highlighted **BLUE** are Officially Licensed Mopar Authentic Restoration Products

FLOOR

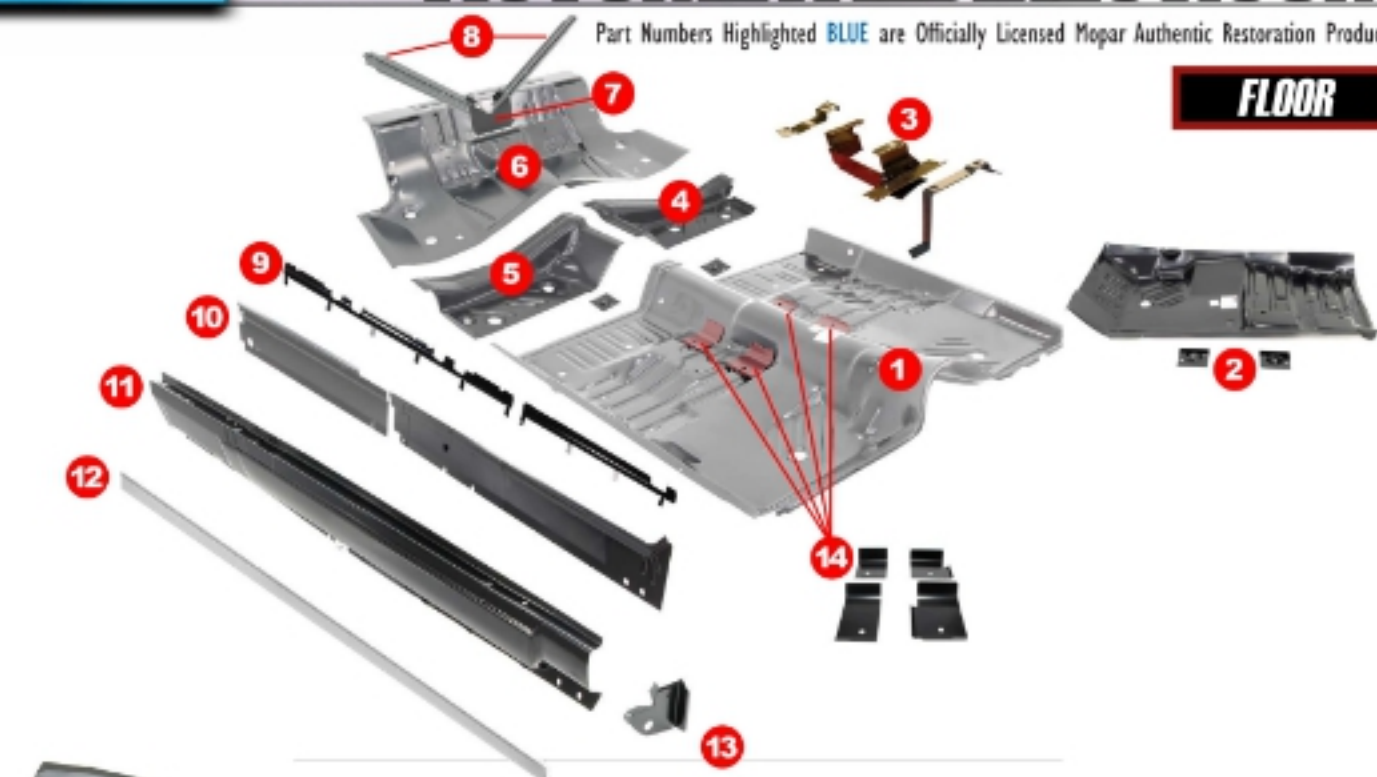

15



16



17

#	YEAR	DESCRIPTION	MODEL	PART #
1	62-65	Front Floor Pan - Full OE Style	All B-Body	400-1462
	66-70	Front Floor Pan - OE Style	All B-Body	400-1466
	71-74	Floor Pan - OE Style	All B-Body	400-1571
2	66-70	Front Floor Pan Half - LH	All B-Body	405-1466-L
	66-70	Front Floor Pan Half - RH	All B-Body	405-1466-R
	71-74	Front Floor Pan Half - LH	All B-Body	405-1571-L
	71-74	Front Floor Pan Half - RH	All B-Body	405-1571-R
3	66-70	Console Bracket Set - Automatic Transmission	All B-Body	490-1466-AS
	66-70	Console Bracket Set - Manual Transmission	All B-Body	490-1466-MS
4	66-70	Rear Footwell Area Floor Pan - LH	All B-Body	410-1466-L
5	66-70	Rear Footwell Area Floor Pan - RH	All B-Body	410-1466-R
	71-72	Rear Footwell Area Floor Pan - LH - (Modify to fit 72)	All B-Body	410-1471-L
	71-72	Rear Footwell Area Floor Pan - RH - (Modify to fit 72)	All B-Body	410-1471-R
6	63-70	Rear Floor / Under Rear Seat Pan - (Modify to fit 63-67)	All B-Body	420-1468
7	68-70	Rear Seat Y-Brace Anchor	All B-Body	639-1468-1
8	68-70	Rear Seat Y-Brace Set	All B-Body	639-1468-2P
9	66-70	Floor Wiring Cover Set	All B-Body	442-1466-S
10	66-70	Inner Rocker Panel - LH	Plymouth B-Body	440-1466-L
	66-70	Inner Rocker Panel - RH	Plymouth B-Body	440-1466-R
11	68-70	Outer Rocker Panel - LH	All B-Body	450-1468-L
	68-70	Outer Rocker Panel - RH	All B-Body	450-1468-R
12	68-70	Rocker Panel Molding Set	Dodge B-Body	K-MN1445
	68-70	Rocker Panel Moldings - 2pcs	Plymouth B-Body	X452-1468-P
13	68-70	Rocker Panel Front End Cap - LH	All B-Body	451-1468-L
	68-70	Rocker Panel Front End Cap - RH	All B-Body	451-1468-R
14	68-70	Bucket Seat Floor Brackets	All B-Body	407-1466-S
	71-74	Bucket Seat Bracket Kit	All B-Body	X407-1471-S
15	66-70	Four Speed Shifter Tunnel	All B-Body	415-1466
	71-74	Four Speed Shifter Tunnel - w/ Bench or Buckets - w/ Center Folding Armrest	All B-Body	415-1471
	71-74	Four Speed Shifter Tunnel - w/ Bucket Seats	All B-Body	415-1570
16	68-70	Rocker Molding Clip Set - (except Charger)	All B-Body	A-270280
	71-73	Rocker Molding Clip Set	All B-Body	A-270271
17	68-70	Rear Seat Back Retainer Set	All B-Body	411-1468-P



VISIT US ONLINE
FOR THE MOST
UP-TO-DATE PRICING
AND SELECTION



WARNING: Cancer and Reproductive
Harm - www.P65Warnings.ca.gov



**AUTHENTIC
RESTORATION**

WWW.AUTOMETALDIRECT.COM

866.719.9505

24



B-BODY

Part Numbers Highlighted **BLUE** are Officially Licensed Mopar Authentic Restoration Products



ROOF



#	YEAR	DESCRIPTION	MODEL	PART #
1	68-70	Roof Skin - (except Charger)	All B-Body	600-1468
	68-70	Roof Skin	Charger	600-2668
2	68-70	Windshield Bow - Lower Inner Top - 2dr Hardtop	All B-Body	610-1468-8
3	68-70	Windshield Bow - Upper Outer Top - 2dr Hardtop	All B-Body	610-1468-9
4	68-70	Roof Bow - Front	All B-Body	610-1468-4
5	68-70	Roof Bow - Rear	All B-Body	610-1468-6
6	68-70	Roof Bow - Upper Rear	Charger	610-2668-1
7	68-70	Roof Bow End Caps - 4 pcs	All B-Body	610-1468-12S
8	68-70	Windshield A-Pillar Post Outer Section - LH	All B-Body	375-1468-1L
	68-70	Windshield A-Pillar Post Outer Section - RH	All B-Body	375-1468-1R
9	68-70	Windshield A-Pillar Post Inner Section - LH	All B-Body	375-1468-2L
	68-70	Windshield A-Pillar Post Inner Section - RH	All B-Body	375-1468-2R
10	68-70	A-Pillar Inner Brace - LH	Charger	610-1468-10L
	68-70	A-Pillar Inner Brace - LH	Charger	610-1468-10R
11	68-70	Roof Side Rail - Inner - LH	All B-Body	610-1468-5L
	68-70	Roof Side Rail - Inner - RH	All B-Body	610-1468-5R
12	68-70	Roof Side Rail - Outer - LH	All B-Body	610-1468-11L
	68-70	Roof Side Rail - Outer - RH	All B-Body	610-1468-11R
13	68-70	C-Pillar Lower Support - LH	Charger	654-2668-1L
	68-70	C-Pillar Lower Support - RH	Charger	654-2668-1R
14	68-70	C-Pillar Vertical Post - Wheelhouse to Rear Window Frame - LH	All B-Body	610-1468-3L
	68-70	C-Pillar Vertical Post - Wheelhouse to Rear Window Frame - RH	All B-Body	610-1468-3R
15	68-70	Roof Drip Rails - Pair	All B-Body	620-1468-S
16	68-70	Pillar Post Weatherstrips - Pair	All B-Body	J-CH2017
17	68-70	Roof Rail Weatherstrips - Pair - Hardtop	All B-Body	J-CH2015



VISIT US ONLINE FOR THE MOST UP-TO-DATE PRICING AND SELECTION



BODY-REAR

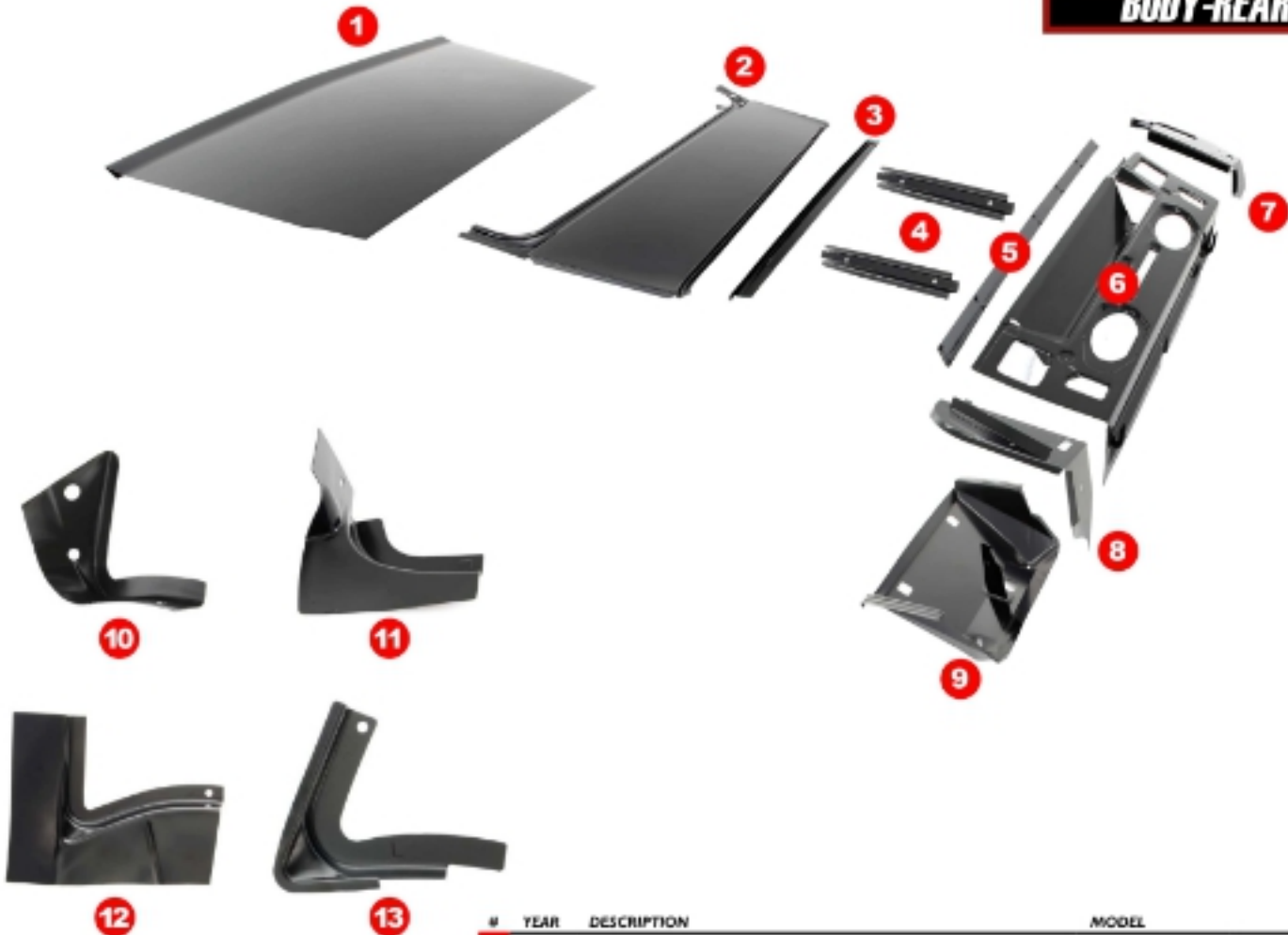

#	YEAR	DESCRIPTION	MODEL	PART #
1	68-70	Deck Lid - (modify for 70)	Charger	850-2668
2	68-70	Deck Filler Panel - (except Charger & Convertible)	All B-Body	650-1468
	68-70	Deck Filler Panel	Charger	650-2668
	71-74	Deck Filler Panel	Plymouth B-Body	650-1471
3	68-70	Window Frame - Lower Rear - (except Charger)	All B-Body	655-1468
	68-70	Window Frame - Lower Rear	Charger	655-2668
4	68-70	Deck Filler Support - (except Charger)	All B-Body	651-1468
5	68-70	Interior Trim Retainer	Charger	640-2668-1
6	68-70	Package Tray - (except Charger)	All B-Body	640-1468
	68-70	Package Tray	Charger	640-2668
7	68-70	Package Tray Extension - LH - (except Charger)	All B-Body	640-1468-L
	68-70	Package Tray Extension - LH	Charger	640-2668-L
8	68-70	Package Tray Extension - RH - (except Charger)	All B-Body	640-1468-R
	68-70	Package Tray Extension - RH	Charger	640-2668-R
9	68-70	Deck Filler Panel Lower Plenum	Charger	656-2668
10	68-70	Back Glass Lower Corner Filler - LH - (except Charger)	All B-Body	654-1468-3L
	68-70	Back Glass Lower Corner Filler - RH - (except Charger)	All B-Body	654-1468-3R
11	68-70	Deck Filler Corner - LH	Charger	654-2668-L
	68-70	Deck Filler Corner - RH	Charger	654-2668-R
12	68-70	Deck Filler Outside Corner Patch - LH - (except Charger)	All B-Body	654-1468-1L
	68-70	Deck Filler Outside Corner Patch - RH - (except Charger)	All B-Body	654-1468-1R
13	68-70	Deck Filler Inside Corner Patch - LH - (except Charger)	All B-Body	654-1468-2L
	68-70	Deck Filler Inside Corner Patch - RH - (except Charger)	All B-Body	654-1468-2R



VISIT US ONLINE
FOR THE MOST
UP-TO-DATE PRICING
AND SELECTION



WARNING: Cancer and Reproductive
Harm - www.P65Warnings.ca.gov



**AUTHENTIC
RESTORATION**

WWW.AUTOMETALDIRECT.COM

866.719.9505

26



B-BODY

Part Numbers Highlighted **BLUE** are Officially Licensed Mopar Authentic Restoration Products

QUARTER PANELS - PLYMOUTH



7



8



2



3



4



5



6

#	YEAR	DESCRIPTION	MODEL	PART #
1	63-65	Quarter Panel - OE Style - LH	Plymouth B-Body	700-1463-L
	63-65	Quarter Panel - OE Style - RH	Plymouth B-Body	700-1463-R
2	66-67	Quarter Panel - OE Style - LH - ZDR Hardtop	Plymouth B-Body	700-1466-L
	66-67	Quarter Panel - OE Style - RH - ZDR Hardtop	Plymouth B-Body	700-1466-R
3	68	Quarter Panel - OE Style - LH	Plymouth B-Body	700-1468-L
	68	Quarter Panel - OE Style - RH	Plymouth B-Body	700-1468-R
4	69	Quarter Panel - OE Style - LH	Plymouth B-Body	700-1469-L
	69	Quarter Panel - OE Style - RH	Plymouth B-Body	700-1469-R
5	70	Quarter Panel - OE Style - LH	Plymouth B-Body	700-1470-L
	70	Quarter Panel - OE Style - RH	Plymouth B-Body	700-1470-R
6	71	Quarter Panel - OE Style - LH	Plymouth B-Body	700-1471-L
	71	Quarter Panel - OE Style - RH	Plymouth B-Body	700-1471-R
7	62-65	Vent Window Support Bracket - LH	All B-Body	562-1462-L
	62-65	Vent Window Support Bracket - RH	All B-Body	562-1462-R
8	66-67	Quarter U-jamb Seals - Pair	All B-Body	A-150200
	68-70	Quarter U-jamb Seals - Pair - ZDR Hardtop & ZDR Sedan	All B-Body	F-464-5



VISIT US ONLINE
FOR THE MOST
UP-TO-DATE PRICING
AND SELECTION



Part Numbers Highlighted **BLUE** are Officially Licensed Mopar Authentic Restoration Products

QUARTER PANELS - DODGE



1



2

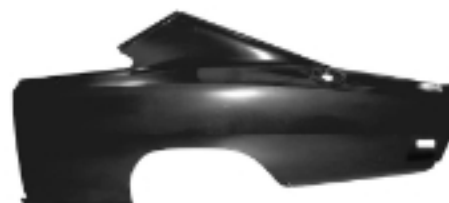

3



4



5



6



7



8

#	YEAR	DESCRIPTION	MODEL	PART #
1	68	Quarter Panel - OE Style - LH	Charger	700-2668-L
	68	Quarter Panel - OE Style - RH	Charger	700-2668-R
2	69	Quarter Panel - OE Style - LH	Coronet	700-2469-L
	69	Quarter Panel - OE Style - RH	Coronet	700-2469-R
3	69	Quarter Panel - OE Style - LH	Charger	700-2669-L
	69	Quarter Panel - OE Style - RH	Charger	700-2669-R
4	70	Quarter Panel - OE Style - LH	Charger	700-2670-L
	70	Quarter Panel - OE Style - RH	Charger	700-2670-R
5	71	Quarter Panel - OE Style - LH	Charger	700-2671-L
	71	Quarter Panel - OE Style - RH	Charger	700-2671-R
6	73-74	Quarter Panel - OE Style - LH	Charger	700-2673-L
	73-74	Quarter Panel - OE Style - RH	Charger	700-2673-R
7	68-70	Quarter Panel Patch - Lower Rear - LH	Charger	755-2668-1L
	68-70	Quarter Panel Patch - Lower Rear - RH	Charger	755-2668-1R
8	66-67	Quarter U-Jamb Seals - Pair	All B-Body	A-150200
	68-70	Quarter U-Jamb Seals - Pair	All B-Body	F-464-5



VISIT US ONLINE
FOR THE MOST
UP-TO-DATE PRICING
AND SELECTION



WARNING: Cancer and Reproductive
Harm - www.P65Warnings.ca.gov



**AUTHENTIC
RESTORATION**
PRODUCT

WWW.AUTOMETALDIRECT.COM

866.719.9505

28



B-BODY

Part Numbers Highlighted **BLUE** are Officially Licensed Mopar Authentic Restoration Products



WHEELHOUSE



#	YEAR	DESCRIPTION	MODEL	PART #
1	63-65	Outer Wheelhouse - LH	Plymouth B-Body	770-1463-L
	63-65	Outer Wheelhouse - RH	Plymouth B-Body	770-1463-R
2	66-67	Outer Wheelhouse - LH - ZDR Hardtop & Sedan	Plymouth B-Body	770-1466-L
	66-67	Outer Wheelhouse - RH - ZDR Hardtop & Sedan	Plymouth B-Body	770-1466-R
3	68-70	Outer Wheelhouse - LH	Plymouth B-Body	770-1468-L
	68-70	Outer Wheelhouse - RH	Plymouth B-Body	770-1468-R
4	68-70	Outer Wheelhouse - LH	Dodge B-Body	770-2468-L
	68-70	Outer Wheelhouse - RH	Dodge B-Body	770-2468-R
5	71-74	Outer Wheelhouse - LH	Plymouth B-Body	770-1471-L
	71-74	Outer Wheelhouse - RH	Plymouth B-Body	770-1471-R
6	71-74	Outer Wheelhouse - LH	Charger	770-2671-L
	71-74	Outer Wheelhouse - RH	Charger	770-2671-R
7	66-70	Inner Wheelhouse - 3" Wider - LH	All B-Body	760-1466-1L
	66-70	Inner Wheelhouse - 3" Wider - RH	All B-Body	760-1466-1R
8	66-70	Inner Wheelhouse - LH	All B-Body	760-1466-L
	66-70	Inner Wheelhouse - RH	All B-Body	760-1466-R
9	71-74	Inner Wheelhouse - LH	All B-Body	760-1471-L
	71-74	Inner Wheelhouse - RH	All B-Body	760-1471-R
10	66-70	Mini-Tub & Rear Spring Relocation Combo	All B-Body	X760-1466-2S
11	66-70	Mini-Tub Set	All B-Body	X760-1466-1S
	71-73	Mini-Tub Set	All B-Body	X760-1471-1S

WWW
VISIT US ONLINE
FOR THE MOST
UP-TO-DATE PRICING
AND SELECTION



INNER STRUCTURE

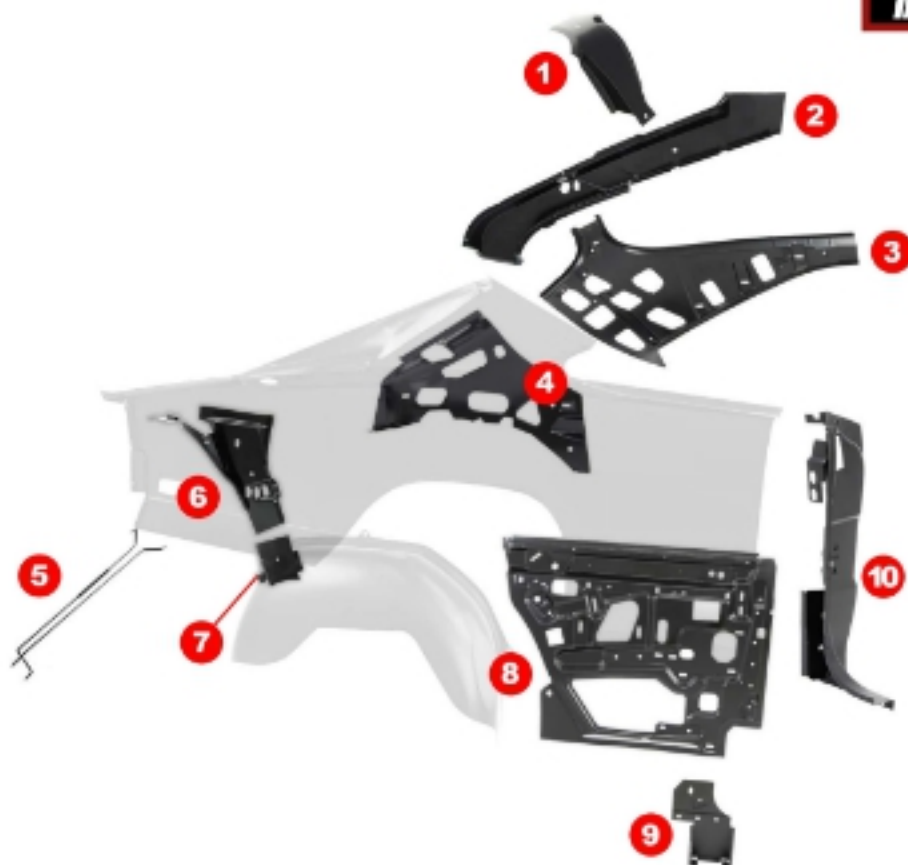

#	YEAR	DESCRIPTION	MODEL	PART #
1	68-70	Sail Panel Stiffener - LH	Charger	610-2668-2L
	68-70	Sail Panel Stiffener - RH	Charger	610-2668-2R
2	68-70	C-Pillar Vertical Post - Wheelhouse to Rear Window Frame - LH	All B-Body	610-1468-3L
	68-70	C-Pillar Vertical Post - Wheelhouse to Rear Window Frame - RH	All B-Body	610-1468-3R
3	68-70	Sail Panel - Inner - LH	Charger	726-2668-1L
	68-70	Sail Panel - Inner - RH	Charger	726-2668-1R
4	68-70	C-Pillar Lower Support - LH	Charger	654-2668-1L
	68-70	C-Pillar Lower Support - RH	Charger	654-2668-1R
5	68-70	Trunk Deck Lid Torsion Spring Rods - Pair - Late Production '68	Charger	656-2668-P
	68-69	Trunk Lid Torque Rods - Pair	Dodge B-Body	K-2838620
6	68-70	Trunk Support - Upper - LH	Charger	764-2668-2L
	68-70	Trunk Support - Upper - RH	Charger	764-2668-2R
7	68-70	Deck Support - Lower - LH	Charger	764-2668-1L
	68-70	Deck Support - Lower - RH	Charger	764-2668-1R
8	68-70	Quarter Panel - Inner - LH	All B-Body	714-1468-1L
	68-70	Quarter Panel - Inner - RH	All B-Body	714-1468-1R
9	68-70	Rocker Panel to Door Pillar Brace - LH	All B-Body	440-1468-1L
	68-70	Rocker Panel to Door Pillar Brace - RH	All B-Body	440-1468-1R
	68-70	Rocker Panel to Door Pillar Braces - Pair	All B-Body	440-1468-2P
10	68-70	Door Jamb Lock Pillar Post - LH - ZDR Sedan	All B-Body	750-1468-1L
	68-70	Door Jamb Lock Pillar Post - RH - ZDR Sedan	All B-Body	750-1468-1R
	68-70	Door Jamb Lock Pillar - LH - ZDR Hardtop	All B-Body	750-1468-2L
	68-70	Door Jamb Lock Pillar - RH - ZDR Hardtop	All B-Body	750-1468-2R
	68-70	Door Jamb Lock Pillar - LH	Charger	750-2668-2L
	68-70	Door Jamb Lock Pillar - RH	Charger	750-2668-2R



TRUNK



5

6



7



8



9

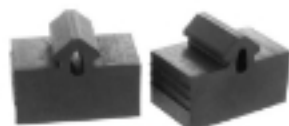

10



11

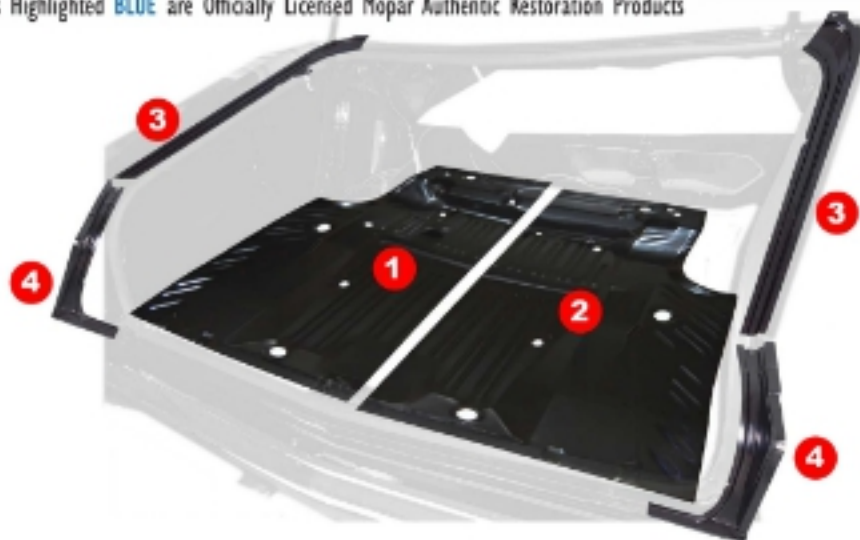

#	YEAR	DESCRIPTION	MODEL	PART #
1	68-70	Trunk Floor Half - LH - (except Charger)	All B-Body	805-1468-L
	68-70	Trunk Floor Half - LH	Charger	805-2668-L
	71-73	Trunk Floor Half - LH	All B-Body	805-1471-L
2	68-70	Trunk Floor Half - RH - (except Charger)	All B-Body	805-1468-R
	68-70	Trunk Floor Half - RH	Charger	805-2668-R
	71-73	Trunk Floor Half - RH	All B-Body	805-1471-R
3	68-70	Trunk Gutter - Upper - LH	Plymouth B-Body	825-1468-1L
	68-70	Trunk Gutter - Upper - RH	Plymouth B-Body	825-1468-1R
	68-70	Trunk Gutter - Upper - LH	Coronet	825-2468-1L
	68-70	Trunk Gutter - Upper - RH	Coronet	825-2468-1R
4	68	Trunk Gutter - Lower - LH	Plymouth B-Body	825-1468-L
	68	Trunk Gutter - Lower - RH	Plymouth B-Body	825-1468-R
	68	Trunk Gutter - Lower - LH	Coronet	825-2468-L
	68	Trunk Gutter - Lower - RH	Coronet	825-2468-R
	69	Trunk Gutter - Lower - LH	Plymouth B-Body	825-1469-L
	69	Trunk Gutter - Lower - RH	Plymouth B-Body	825-1469-R
	69	Trunk Gutter - Lower - LH	Coronet	825-2469-L
	69	Trunk Gutter - Lower - RH	Coronet	825-2469-R
	70	Trunk Gutter - Lower - LH	Plymouth B-Body	825-1470-L
	70	Trunk Gutter - Lower - RH	Plymouth B-Body	825-1470-R
	5	68-70	Trunk Gutter - LH	Charger
68-70		Trunk Gutter - RH	Charger	825-2668-R
71-74		Trunk Gutter - LH	Charger	825-2671-L
71-74		Trunk Gutter - RH	Charger	825-2671-R
71-74		Trunk Gutter - LH	Plymouth B-Body	825-1471-L
6	71-74	Trunk Gutter - RH	Plymouth B-Body	825-1471-R
	66-67	Trunk Weatherstrip	Charger	F-TW2
7	66-67	Trunk Weatherstrip - (except Charger)	All B-Body	F-TW1
	68-69	Trunk Weatherstrip - (except Charger)	Dodge B-Body	F-TW5
	68-69	Trunk Weatherstrip	Plymouth B-Body	F-TW6
	68-70	Trunk Weatherstrip	Charger	F-TW9
	70	Trunk Weatherstrip - (except Charger)	All B-Body	F-TW7
	71-72	Trunk Weatherstrip	All B-Body	F-TW730
	73-74	Trunk Weatherstrip	All B-Body	F-TW830
	8	66-67	Vent Tube Thru Trunk Floor Grommet	All B-Body
9	68-70	Trunk & Rear of Hood Bumper	Charger	F-714
	10	66-70	Trunk Bumper Set - 2pcs	All B-Body
11	66-74	Trunk Bumper	All B-Body	F-307
	69	Trunk Bumper Set - 2pcs	Coronet	J-CH2003
	69	Trunk Bumpers	Coronet	F-869



TRUNK FLOOR



#	YEAR	DESCRIPTION	MODEL	PART #
1	62-65	Trunk Floor - Full OE Style	All B-Body	800-1462
	66-67	Trunk Floor - OE Style	All B-Body	800-1466
	68-70	Trunk Floor - OE Style - (except Charger)	All B-Body	800-1468
	68-70	Trunk Floor - OE Style	Charger	800-2668
	71-74	Trunk Floor - OE Style - (Modify for 74 Models)	All B-Body	800-1471
2	66-67	Trunk Floor Extension - LH	Plymouth B-Body	840-1466-L
	66-67	Trunk Floor Extension - RH	Plymouth B-Body	840-1466-R
	68-70	Trunk Floor Extension - LH	Plymouth B-Body	840-1468-L
	68-70	Trunk Floor Extension - RH	Plymouth B-Body	840-1468-R
	68-70	Trunk Floor Extension - LH - (except Charger)	Dodge B-Body	840-2468-L
	68-70	Trunk Floor Extension - RH - (except Charger)	Dodge B-Body	840-2468-R
	68-70	Trunk Floor Extension - LH	Charger	840-2668-L
	68-70	Trunk Floor Extension - RH	Charger	840-2668-R
	71-74	Trunk Floor Extension - LH	Plymouth B-Body	840-1471-L
	71-74	Trunk Floor Extension - RH	Plymouth B-Body	840-1471-R
	71-74	Trunk Floor Extension - LH	Charger	840-2671-L
3	71-74	Trunk Floor Extension End Cap - LH	Plymouth B-Body	841-1471-L
	71-74	Trunk Floor Extension End Cap - RH	Plymouth B-Body	841-1471-R
4	62-65	Trunk Floor Brace	All B-Body	820-1462
	68-70	Trunk Floor Braces - 3pcs	All B-Body	820-1468-S
	71-73	Trunk Floor Braces - 2pcs	All B-Body	820-1471-P
5	68-69	Trunk Lock Support	Plymouth B-Body	810-1468
	68-70	Trunk Lock Support	Charger	810-2668
	69	Trunk Lock Support	Coronet	810-2469
	70	Trunk Lock Support	Plymouth B-Body	810-1470
6	66-72	Trunk Lock Set	All B-Body	X828-1466-S
	73-74	Trunk Lock Set	All B-Body	A-280551
7	68-70	Trunk Bolt Set	All B-Body	A-270725

 VISIT US ONLINE
 FOR THE MOST
 UP-TO-DATE PRICING
 AND SELECTION





TAIL PANEL

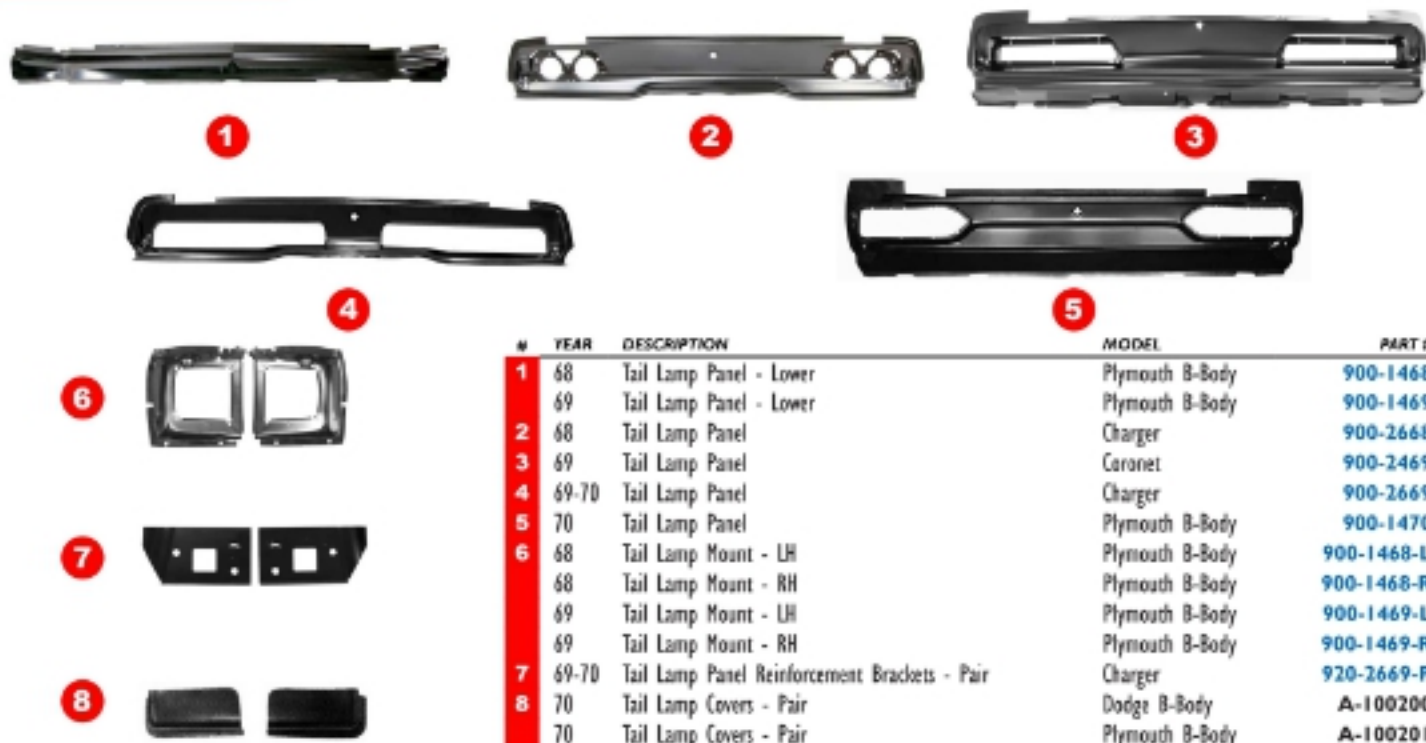

#	YEAR	DESCRIPTION	MODEL	PART #
1	68	Tail Lamp Panel - Lower	Plymouth B-Body	900-1468
	69	Tail Lamp Panel - Lower	Plymouth B-Body	900-1469
2	68	Tail Lamp Panel	Charger	900-2668
3	69	Tail Lamp Panel	Coronet	900-2469
4	69-70	Tail Lamp Panel	Charger	900-2669
5	70	Tail Lamp Panel	Plymouth B-Body	900-1470
6	68	Tail Lamp Mount - LH	Plymouth B-Body	900-1468-L
	68	Tail Lamp Mount - RH	Plymouth B-Body	900-1468-R
	69	Tail Lamp Mount - LH	Plymouth B-Body	900-1469-L
	69	Tail Lamp Mount - RH	Plymouth B-Body	900-1469-R
7	69-70	Tail Lamp Panel Reinforcement Brackets - Pair	Charger	920-2669-P
8	70	Tail Lamp Covers - Pair	Dodge B-Body	A-100200
	70	Tail Lamp Covers - Pair	Plymouth B-Body	A-100201

REAR VALANCE



#	YEAR	DESCRIPTION	MODEL	PART #
1	68	Rear Valance - w/o Reverse Light Holes	Charger	960-2668
2	69-70	Rear Valance - w/ Reverse Light Holes	Charger	960-2669
3	71	Rear Valance - w/Exhaust Tip Cutouts	Plymouth B-Body	960-1471-T
4	71-72	Rear Valance - w/ Exhaust Tip Cutouts	Charger	960-2671-T
5	73-74	Rear Valance - w/ Exhaust Tip Cutouts	Charger	960-2673-T
6	68-70	Trunk Floor to Valance Reinforcements - Pair	Charger	962-2668-S
7	68-70	Rear Valance Corner - LH	Charger	776-2668-L
	68-70	Rear Valance Corner - RH	Charger	776-2668-R
8	71	Rear Valance Bolt Kit	Plymouth B-Body	A-270821



VISIT US ONLINE
FOR THE MOST
UP-TO-DATE PRICING
AND SELECTION



Part Numbers Highlighted **BLUE** are Officially Licensed Mopar Authentic Restoration Products

SPARE TIRE



1



2



3



4



5



6



7



8



9



10

#	YEAR	DESCRIPTION	MODEL	PART #
1	68	Spare Tire Hardware Set	All B-Body	816-1468-25
	68-70	Spare Tire Hardware Set - Convertible	All B-Body	816-1468-75
	68-74	Spare Tire Hardware Set - Hardtop & Convertible	All B-Body	816-1468-95
	71-74	Spare Tire Hardware Set	All B-Body	816-1471-105
2	68-74	Spare Tire Wing Nut	All B-Body	816-1468-1
3	68	Spare Tire Stud	All B-Body	816-1468-2
4	69-70	Soud Only - 7 1/2 w/ 5 1/4 Thread	All B-Body	816-1468-7
	69-70	Soud Only - 9 1/4 w/ 4 1/2 Thread	All B-Body	816-1468-9
	71-74	Soud Only - 10 1/2 w/ 4 1/2 Thread	All B-Body	816-1471-10
5	62-65	Spare Tire Hold Down Bracket	All B-Body	817-1462
	68	Spare Tire Hold Down Bracket	All B-Body	817-1468-1
	69-70	Spare Tire Hold Down Bracket	All B-Body	817-1468-2
6	68-70	Spare Tire Support	Charger	817-2668-S
7	68-70	Jack Bracket Hold Down - (except Charger)	All B-Body	818-1468-15
8	68-74	Jack Bracket Spring Hook	All B-Body	818-1570-1L
9	68-70	Jack Bracket - front	Charger	818-2668-1
10	68-70	Jack Bracket - Rear	Charger	818-1570-2L

1



2



BODY BUMPERS & PLUGS

#	YEAR	DESCRIPTION	MODEL	PART #
1	66-67	Body Bumper Set	All B-Body	F-BBK01
	68-69	Body Bumper Set	Plymouth B-Body	F-BBK02
	68-69	Body Bumper Set - (except Charger)	Dodge B-Body	F-BBK03
	68-70	Body Bumper Set	Charger	F-BBK05
	70	Body Bumper Set	Plymouth B-Body	F-BBK02A
	70	Body Bumper Set - (except Charger)	Dodge B-Body	F-BBK04
	71	Body Bumper Set	All B-Body	F-BBK06
	72	Body Bumper Set	All B-Body	F-BBK06A
	73-74	Body Bumper Set	Plymouth B-Body	F-BBK16
	73-74	Body Bumper Set	Dodge B-Body	F-BBK17
2	66-67	Body Plug Set - (except Charger)	All B-Body	F-BPK7
	66-67	Body Plug Set	Charger	F-BPK9
	68	Body Plug Set	All B-Body	F-BPK11
	69	Body Plug Set	All B-Body	F-BPK12
	70	Body Plug Set	All B-Body	F-BPK13
	71-72	Body Plug Set	All B-Body	F-BPK14
	73-74	Body Plug Set - (except Charger)	All B-Body	F-BPK15
	73-74	Body Plug Set	Charger	F-BPK16



VISIT US ONLINE FOR THE MOST UP-TO-DATE PRICING AND SELECTION



WARNING: Cancer and Reproductive Harm - www.P65Warnings.ca.gov



AUTHENTIC RESTORATION

WWW.AUTOMETALDIRECT.COM

866.719.9505

CHASSIS STIFFENING

Level 1 Kit Includes:

- Weld-in Frame Connectors
- Front & Rear Torque Boxes

Level 2 Kit Includes:

- Weld-in Frame Connectors
- Front & Rear Torque Boxes
- Inner Fender Braces
- Lower Radiator Core Support Brace

Level 3 Kit Includes:

- Weld-in Frame Connectors
- Front & Rear Torque Boxes
- Inner Fender Braces
- Lower Radiator Core Support Brace
- Rear Spring Relocation Kit
- Mini Tub Kit

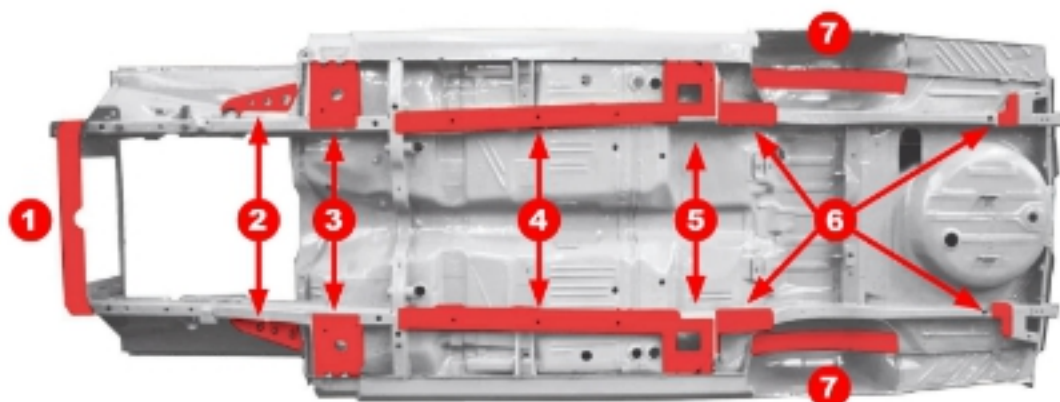

12

13



VISIT US ONLINE
FOR THE MOST
UP-TO-DATE PRICING
AND SELECTION



#	YEAR	DESCRIPTION	MODEL	PART #
	66-70	Level 1 Chassis Stiffening Kit	All B-Body	X897-1466-1S
	66-70	Level 2 Chassis Stiffening Kit	All B-Body	X897-1466-2S
	66-70	Level 3 Chassis Stiffening Kit	Plymouth B-Body	X897-1466-3S
	71-72	Level 1 Chassis Stiffening Kit	All B-Body	X897-1471-1S
	66-70	Level 3 Chassis Stiffening Kit	Dodge B-Body	X897-2466-3S
	66-70	Front & Rear Torque Box Set - 4pcs	All B-Body	X439-1466-4S
	71-72	Front & Rear Torque Box Set - 4pcs	All B-Body	X439-1471-4S
1	66-70	Core Support Stiffener	All B-Body	X349-1466-1
2	66-70	Inner Fender Brace Set	All B-Body	X253-1466-S
3	66-70	Front Torque Boxes - Pair	All B-Body	X439-1466-1S
4	66-70	Weld-in Frame Connectors	All B-Body	X896-1466-P
	71-72	Weld-in Frame Connectors	All B-Body	X896-1471-P
	73-75	Weld-in Frame Connectors - w/o Catalytic Converter	All B-Body	X896-1473-P
5	66-70	Rear Torque Boxes - Pair	All B-Body	X439-1466-2S
6	66-70	Leaf Spring Relocation Set - Front And Rear	Plymouth B-Body	X865-1466-1S
	66-70	Leaf Spring Relocation Set - Front And Rear	Dodge B-Body	X865-2466-1S
	66-70	Leaf Spring Relocation Buckets - Front - Pair	Plymouth B-Body	X865-1466-2S
	66-70	Leaf Spring Relocation Buckets - Front - Pair	Dodge B-Body	X865-2466-2S
	66-70	Leaf Spring Relocation Hanger - Rear - Pair	All B-Body	X865-1466-3S
	71-72	Leaf Spring Relocation Set - Front And Rear	All B-Body	X865-1471-1S
7	66-70	Mini-Tub & Leaf Spring Relocation Combo	All B-Body	X760-1466-2S
	66-70	Mini-Tub Set	All B-Body	X760-1466-1S
	71-73	Mini-Tub Set	All B-Body	X760-1471-1S
8	62-76	Leaf Spring Perches - Pair	All B-Body	X865-1000-P
9	70-74	Crossmember Set - 518 Style	All B-Body	X395-1570-2
10	62-76	Tubular K-Frame Adapters - Pair	All B-Body	X394-1466-2P
11	62-76	K-Frame Bolts	All B-Body	X394-1466-1S
12	64-72	Driveshaft Loop - Bolt In	All B-Body	X419-1464-1
13	73-74	Disc Brake Backing Plates - Pair	All B-Body	K-MN1521

Part Numbers Highlighted **BLUE** are Officially Licensed Mopar Authentic Restoration Products

MIRROR



#	YEAR	DESCRIPTION	MODEL	PART #
1	67-70	Chrome Mirror w/ Pentastar Logo - LH or RH	All B-Body	F-834
	67-70	Chrome Mirror w/o Pentastar Logo - RH	All B-Body	F-869R
2	67-70	Chrome Remote Mirror w/ Hardware - LH	All B-Body	F-508R
3	71-72	Outside Mirror - Sport Style - Chrome - Remote - LH	All B-Body	X570-1571-1L
4	71-72	Outside Mirror - Sport Style - Chrome - Manual - RH	All B-Body	X570-1571-1R
	73-74	Outside Mirror - Sport Style - Chrome - Manual - LH	All B-Body	X570-1473-1L
	73-74	Outside Mirror - Sport Style - Chrome - Manual - RH	All B-Body	X570-1473-1R
5	66-70	Mirror Gasket - LH or RH - (except Twin Post Style)	All B-Body	X570-1067-2
	71-76	Mirror Gasket - LH	All B-Body	F-741L
	71-76	Mirror Gasket - RH	All B-Body	A-151040
6	71-74	Mirror Mounting Set	All B-Body	A-270275
7	66-67	Outside Mirror Bezel - Remote - LH	All B-Body	K-MB1472
	71-74	Outside Mirror Bezel - Remote - LH	Charger	K-MB1247
8	68-69	Rear View Mirror	All B-Body	X645-1068
9	70	Rear View Mirror	All B-Body	K-MD7125
10	71-74	Rear View Mirror - (up to 12/15/71)	All B-Body	X645-1470

SWITCHES

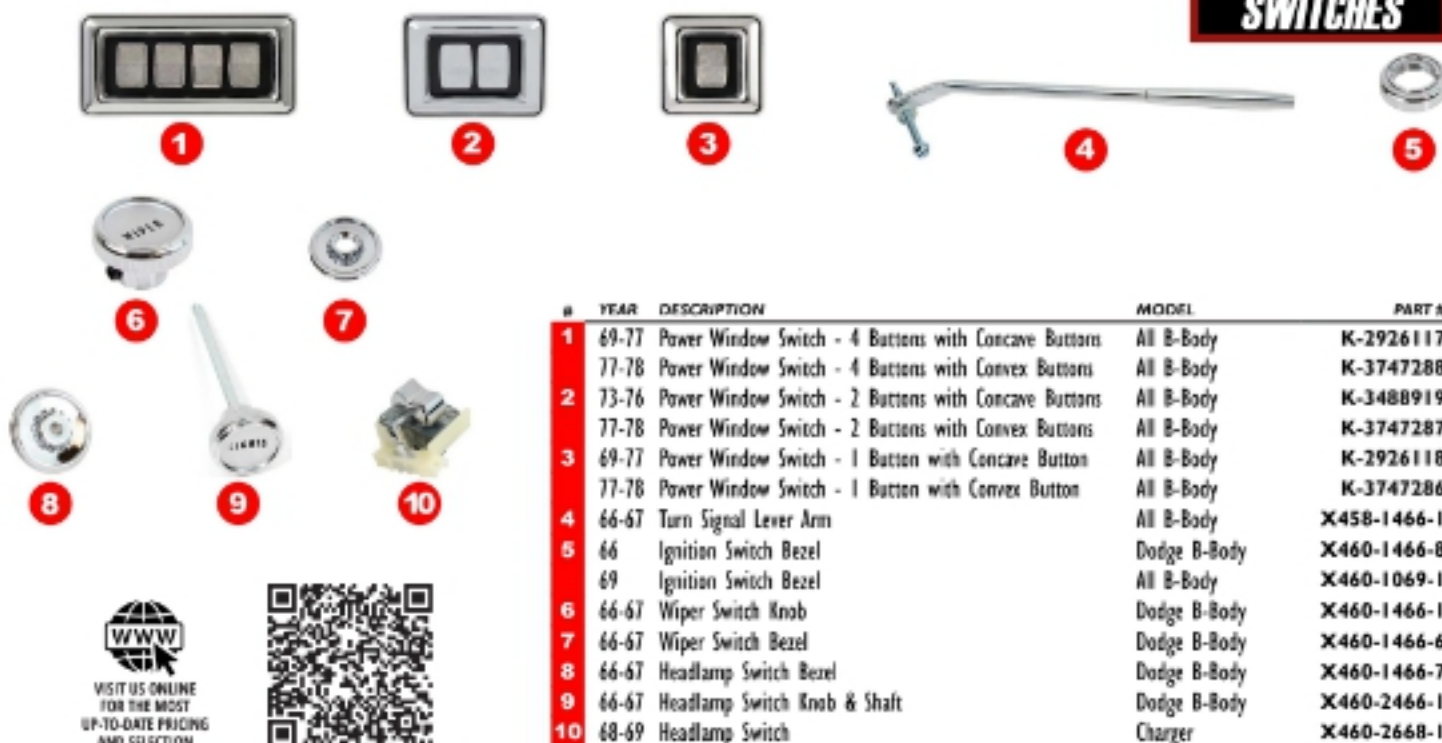

#	YEAR	DESCRIPTION	MODEL	PART #
1	69-77	Power Window Switch - 4 Buttons with Concave Buttons	All B-Body	K-2926117
	77-78	Power Window Switch - 4 Buttons with Convex Buttons	All B-Body	K-3747288
2	73-76	Power Window Switch - 2 Buttons with Concave Buttons	All B-Body	K-3488919
	77-78	Power Window Switch - 2 Buttons with Convex Buttons	All B-Body	K-3747287
3	69-77	Power Window Switch - 1 Button with Concave Button	All B-Body	K-2926118
	77-78	Power Window Switch - 1 Button with Convex Button	All B-Body	K-3747286
4	66-67	Turn Signal Lever Arm	All B-Body	X458-1466-1
5	66	Ignition Switch Bezel	Dodge B-Body	X460-1466-8
	69	Ignition Switch Bezel	All B-Body	X460-1069-1
6	66-67	Wiper Switch Knob	Dodge B-Body	X460-1466-1
7	66-67	Wiper Switch Bezel	Dodge B-Body	X460-1466-6
8	66-67	Headlamp Switch Bezel	Dodge B-Body	X460-1466-7
9	66-67	Headlamp Switch Knob & Shaft	Dodge B-Body	X460-2466-1
10	68-69	Headlamp Switch	Charger	X460-2668-1



VISIT US ONLINE
FOR THE MOST
UP-TO-DATE PRICING
AND SELECTION



WARNING: Cancer and Reproductive
Harm - www.P65Warnings.ca.gov



**AUTHENTIC
RESTORATION**
PRODUCT

WWW.AUTOMETALDIRECT.COM

866.719.9505

36

INTERIOR

1



2



3



4



5



6



7



8



9

#	YEAR	DESCRIPTION	MODEL	PART #
1	66-67	Door Sill Plates - Pair	All B-Body	A-180018
	68-70	Door Sill Plates - Pair	All B-Body	A-180019
	71-74	Door Sill Plates - Pair	All B-Body	T-MPS625
2	68-70	Door Sill Plate Extensions - Pair	All B-Body	S-SPB3
3	66-67	Door Sill Plate Screw Set	All B-Body	A-271102
	68-70	Door Sill Plate Screw Set	All B-Body	A-271103
	71-74	Door Sill Plate Screw Set	All B-Body	A-271104
4	66-70	Console Lid Mounting Kit	All B-Body	A-270282
5	66-70	Console Trim - Rear	All B-Body	X491-1466-5
6	66-70	Console Lamp Lens and Bezel	All B-Body	X491-1468-4
7	66-67	Console Screw Set	Charger	A-271112
	68-70	Console Screw Set - w/ Automatic Transmission	All B-Body	A-271114
	68-70	Console Screw Set - w/ Manual Transmission	All B-Body	A-271115
	71-74	Console Screw Set	All B-Body	A-271113
8	66-70	Convertible Top Latch - LH	All B-Body	X615-1466-L
	66-70	Convertible Top Latch - RH	All B-Body	X615-1466-R
9	66	Interior Trim Screw Set	Belvedere/Satellite	A-271046
	66	Interior Trim Screw Set	Coronet 500	A-271054
	66	Interior Trim Screw Set	Coronet 440	A-271056
	66-67	Interior Trim Screw Set	Charger	A-271008
	67	Interior Trim Screw Set - Convertible	Coronet 440/500	A-271057
	67	Interior Trim Screw Set	Satellite/GTX	A-271006
	68	Interior Trim Screw Set	Charger	X488-2668-5
	68	Interior Trim Screw Set - Hardtop	Coronet	A-271044
	68	Interior Trim Screw Set	Satellite	A-271015
	68	Interior Trim Screw Set	Road Runner	A-271016
	68	Interior Trim Screw Set	GTX	A-271033
	69-70	Interior Trim Screw Set	Charger	A-271009
	69-70	Interior Trim Screw Set	Coronet	A-271045
	69-70	Interior Trim Screw Set - Convertible	GTX/Road Runner	A-271017
	69-70	Interior Trim Screw Set - Hardtop	GTX/Road Runner/Super Bee	A-271018
	71-74	Interior Trim Screw Set	Charger R/T/SE	A-271004
	73-74	Interior Trim Screw Set	Charger SE	A-271005
	71-74	Interior Trim Screw Set	Road Runner	A-271019



VISIT US ONLINE FOR THE MOST UP-TO-DATE PRICING AND SELECTION



INTERIOR



#	YEAR	DESCRIPTION	MODEL	PART #
1	66-74	Dome Light Assembly	All B-Body	S-EF3916
2	66-74	Dome Light Lens	All B-Body	X612-1466-1
3	66-68	Ignition & Door Lock Set - w/o Illumination	All B-Body	A-280547
	70-71	Ignition & Door Lock Set - w/o Illumination	All B-Body	A-280548
	72-74	Ignition & Door Lock Set - w/o Tilt - w/o Telescoping	All B-Body	A-280550
4	68-74	Shift Boot Trim Ring Screw Set	All B-Body	A-270298
5	67-74	Shifter Linkage Boot to Floor Seal	All B-Body	A-150942
	70-74	Steering Wheel Hub Adapter - For S83 Rim Blow and S84 Tuff Options	All B-Body	K-3467186
6	70-74	Rim Blow and Tuff Steering Wheel Mounting Nut - Lug Nut Style	All B-Body	K-6029392
7	68-69	Seat Belt Clips - 2pcs	All B-Body	K-MB1501
8	69	Radio Bezel - Woodgrain	Coronet/GTX/Sport Satellite/R/T	X463-1470
9	69-70	Headrest Post Bezel - w/ Bench Seat	All B-Body	X408-1469-1
10	66-74	Ashtray - Rear	All B-Body	X453-1466
11	68	Lower Dash Panel Trim - Rallye Dash	Dodge B-Body	X460-1468-1P
	69	Lower Dash Panel Trim - Rallye Dash	Dodge B-Body	X460-1469-1P
12	62-74	Glove box Door Bumpers - Pair	All B-Body	J-CH1069
	62-74	Glove box Door Bumper	All B-Body	X461-3062-5
13	64-74	Glove box Door Arm Bumper	All B-Body	X102-1462
14	66-70	Front Armrest Base - Chrome - w/ 9" Pad	All B-Body	X529-1466-13
	66-70	Front Armrest Base - Chrome - w/ 13" Pad	All B-Body	X529-2666
15	66-70	Front Armrest Pad - White - 9"	All B-Body	X529-1466-W
	71-74	Front Armrest Pad - Black - LH	All B-Body	X529-1471-L
	71-74	Front Armrest Pad - Black - RH	All B-Body	X529-1471-R
16	66-70	Rear Armrest Base - Chrome	All B-Body	X529-1466-9
17	66-70	Emergency Cable Bracket	All B-Body	441-1466



VISIT US ONLINE FOR THE MOST UP-TO-DATE PRICING AND SELECTION



WARNING: Cancer and Reproductive Harm - www.P65Warnings.ca.gov



AUTHENTIC RESTORATION

WWW.AUTOMETALDIRECT.COM

866.719.9505



B-BODY

Part Numbers Highlighted **BLUE** are Officially Licensed Mopar Authentic Restoration Products



PEDALS



#	YEAR	DESCRIPTION	MODEL	PART #
1	66-70	Accelerator Pedal - w/o Trim Bezel	All B-Body	X409-1466
2	66-70	Accelerator Pedal Bezel - Stainless	All B-Body	X409-1466-T
3	71-72	Accelerator Pedal with Mounting Hardware - w/o Trim Bezel	All B-Body	X409-1071-S
4	71-72	Accelerator Pedal with Mounting Hardware - w/ Trim Bezel	All B-Body	X409-1071-TS
5	73-74	Accelerator Pedal with Mounting Hardware - w/o Trim Bezel	All B-Body	X409-1073-S
6	73-74	Accelerator Pedal with Mounting Hardware - w/ Trim Bezel	All B-Body	X409-1073-TS
7	66-70	Accelerator Pedal Seal	All B-Body	F-ACG
8	66-70	Brake Pedal Pad - Automatic Transmission	All B-Body	X476-1466-A
9	66-70	Brake Pedal Pad Bezel - Automatic Transmission	All B-Body	X476-1466-AT
10	66-70	Brake-Clutch Pedal Pad - Manual Transmission - Each	All B-Body	X476-1466-M
11	66-70	Brake-Clutch Pedal Pad Bezel - Manual Transmission - Pair	All B-Body	X476-1466-MTP
12	71-72	Brake Pedal Pad - Automatic Transmission	All B-Body	X476-1570-A
13	71-72	Brake Pedal Pad Trim - Automatic Transmission	All B-Body	X476-1570-AT
14	71-72	Brake-Clutch Pedal Pad - Manual Transmission - Each	All B-Body	X476-1570-M
15	71-72	Brake-Clutch Pedal Pad Trim - Manual Transmission - Each	All B-Body	X476-1570-MT
16	73-74	Brake Pedal Pad - Automatic Transmission	All B-Body	X476-1071-A
17	73-74	Brake Pedal Pad Trim - Automatic Transmission	All B-Body	X476-1071-AT
18	73-74	Brake-Clutch Pedal Pad - Manual Transmission - Each	All B-Body	X476-1071-M
19	73-74	Brake-Clutch Pedal Pad - Manual Transmission - Each	All B-Body	J-CH1052
20	66-70	Park Brake Pedal Pad	All B-Body	X476-1466-I
21	71-72	Park Brake Pedal Pad	All B-Body	X476-1570-I
22	66-72	Park Brake Pedal Pad Trim	All B-Body	X476-1466-IT
23	73-74	Park Brake Pedal Pad	All B-Body	X476-1573
24	73-74	Park Brake Pedal Pad Trim	All B-Body	X476-1573-T
25	71-74	Park Brake Release Rod Bushings	All B-Body	X377-1471-3



VISIT US ONLINE FOR THE MOST UP-TO-DATE PRICING AND SELECTION



Part Numbers Highlighted **BLUE** are Officially Licensed Mopar Authentic Restoration Products



MOLDING/TRIM

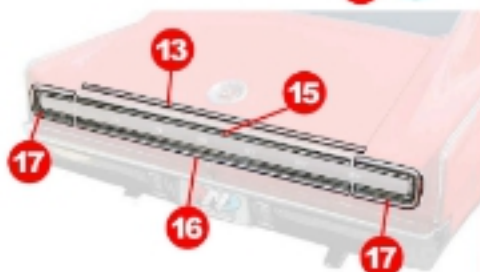

#	YEAR	DESCRIPTION	MODEL	PART #
1	68	Grille Horizontal Molding Set - 2pcs	Charger	X155-2668-P
2	68	Grille Molding Clip Set	Charger	A-270279
3	69	Grille Molding Set - 7pcs - (Except 500 or Daytona)	Charger	X155-2669-1S
4	69	Chrome Center Grille "I" Trim - (except 500 or Daytona)	Charger	X155-2669-1
5	68-70	Windshield Molding Set	All B-Body	385-1468-S
6	68-70	Wheel Opening Molding Set - 4pcs - (except Charger)	Dodge B-Body	F-CRWM
	68-70	Wheel Opening Molding Set - 4pcs - (except 69 GTX)	Plymouth B-Body	F-SAWM
	68-70	Wheel Opening Molding Set - 4pcs	Charger	X230-2668-S
	69	Wheel Opening Molding Set - 4pcs	GTX	X230-1469-1S
	71-72	Wheel Opening Molding Set - 4pcs	Charger	K-MN1483
	71-72	Wheel Opening Molding Set - 4pcs	Plymouth B-Body	K-MN1484
	73-74	Wheel Opening Molding Set - 4pcs	Charger	K-MN1485
7	64-69	Wheel Opening Molding Screw Set - 36pcs	All B-Body	H-C-8017
	70-74	Wheel Opening Molding Screw Set - 36pcs	All B-Body	H-C-8021
8	68-70	Rocker Panel Molding - Pair	Dodge B-Body	K-MN1445
	68-70	Rocker Panel Molding - Pair	Plymouth B-Body	X452-1468-P
9	68-70	Drip Rail Molding Set	Plymouth B-Body	630-1468-S
	68-70	Drip Rail Molding Set	Dodge B-Body	630-2468-S
10	68-70	Back Glass Molding Set - (except Charger)	All B-Body	670-1468-S
	68-70	Back Glass Molding Set	Charger	670-2668-S
11	68-70	Vinyl Top Molding Set - 2DR Hardtop	Plymouth B-Body	635-1468-S
	68-70	Vinyl Top Molding Set - (except Charger)	Dodge B-Body	635-2468-S
	68-70	Vinyl Top Molding Set	Charger	635-2668-S
12	68-70	Vinyl Top Molding Clip Set - 22 pcs	Charger	X635-2668-1S
	71-74	Vinyl Top Molding Clip Set	Charger	A-270502
13	66-67	Deck Lid Molding	Charger	K-2809964
	66	Deck Lid Molding - Upper or Lower - Each	Coronet	K-MN1407
14	70	Deck Lid Molding Clip Set	GTX	A-270274
15	66-67	Tail Lamp Panel Molding - Upper	Charger	K-2807394
	66-67	Tail Lamp Panel Molding - Lower	Charger	X930-2666-1
17	66-67	Tail Lamp Bezels - Pair	Charger	X930-2666-P
18	68	Tail Lamp Panel Molding - Outer & Lower - Pair	Charger	X930-2668-S
19	67	Tail Lamp Bezels with Silver Inners - Pair	GTX/Satellite	K-MB1986
20	67	Tail Lamp Bezels with Red Inners - Pair	GTX/Satellite	K-MB2161
21	71	Tail Lamp Bezels - Pair	GTX/Road Runner	K-MB2165
22	66	Exterior Trim Screw Set	Satellite	A-271242
	66-67	Exterior Trim Screw Set	Charger	A-271224
	66-67	Exterior Trim Screw Set	Coronet	A-271231
	67	Exterior Trim Screw Set	Belvedere	A-271240
	68	Exterior Trim Screw Set	Satellite	A-271244
	68-70	Exterior Trim Screw Set	Charger	A-271225
	69	Exterior Trim Screw Set	Coronet	A-271233
	69	Exterior Trim Screw Set	Road Runner	A-271204
	70	Exterior Trim Screw Set	Road Runner	A-271205
	71	Exterior Trim Screw Set	Charger	A-271226
	73	Exterior Trim Screw Set	Charger	A-271228



WARNING: Cancer and Reproductive Harm - www.P65Warnings.ca.gov



AUTHENTIC RESTORATION

WWW.AUTOMETALDIRECT.COM

866.719.9505



EMBLEMS



1



2



3



4



5



6



7



8



9



10



15



11



12



13



14



16



17



18



19



20



21

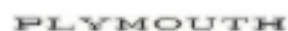

22



23

#	YEAR	DESCRIPTION	MODEL	PART #
1	71-72	Front Bumper Emblem - Arrow	Charger	K-3464348
2	68	Grille Emblem	Coronet R/T	K-2786711
3	69	Grille Emblem - Bumble Bee Logo	Super Bee	K-2949303
4	69	Grille Emblem - "Charger"	Charger 500	K-2840066
5	66-70	Fender Emblem - "V-8" - LH or RH	Charger	K-2998278
6	66-70	Fender Emblem w/ Black Accent - "383" - LH or RH	All B-Body	K-2579748
7	66-70	Fender Emblem w/ Red Accent - "383" - LH or RH	All B-Body	K-2579804
8	66-71	Fender Emblem - "GTX" - LH or RH	All B-Body	K-2785749
9	67	Fender Emblem - "Coronet" - LH or RH	Belvedere/GTX	K-2785518
10	69-72	Fender Emblem - "440" - LH or RH	Coronet	K-2901751
11	69-70	Fender Emblem - "440" - LH or RH	Coronet	K-2901810
11	71	Fender Emblem - "Super Bee" - LH or RH	Super Bee	K-3504804
12	71	Fender Emblem - "Charger" - LH or RH	Charger	K-3504807
13	71-74	Fender & Door Emblem - Arrow	Charger	K-3506410
14	69	Hood Insert Emblem - "383"	Road Runner	999-1469-31
15	67	Hood Ornament Assembly - "440"	GTX	K-2785534
16	68-72	Hood or Rear Deck Emblem - "PLYMOUTH"	All B-Body	K-2785791
17	69	Hood Emblem - "HEMI" - For Air Grabber & Ramcharger Scoops	All B-Body	K-2898876
18	69-70	Hood Emblem - "440" - For Air Grabber & Ramcharger Scoops	All B-Body	K-3613278
19	70	Hood Emblem - Bumble Bee Logo	Super Bee	K-2998065
20	70	Hood Emblem - "R/T"	Coronet	K-2998066
21	71-73	Hood Emblem - "340 Magnum"	Charger	K-3573632
22	66-71	Hood & Trunk Letters - "PLYMOUTH"	Plymouth B-Body	K-RM4124
23	70	Door Scoop Side Emblem - "R/T" w/ Mounting Studs	Charger	T-MP6050
23	70	Door Scoop Side Emblem - "R/T" w/o Mounting Studs	Charger	T-MP6055



VISIT US ONLINE FOR THE MOST UP-TO-DATE PRICING AND SELECTION



EMBLEMS



1



2



3



4

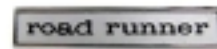

5



6



7



8



9



10



11



12



13



14



15



16



17



18



19



20



21

#	YEAR	DESCRIPTION	MODEL	PART #
1	70	Headlamp Door Emblem - "500"	Charger	K-3443093
2	68	Headlamp Emblem - Arrow	Charger	K-2841849
3	69	Headlamp Door/Grille Emblem - "Charger" Script	Charger	K-2898929
4	68-69	Upper Door Pad Emblem - "Charger" - LH or RH	Charger	T-MP5610
5	70	Upper Door Pad Emblem - "Charger" - LH or RH	Charger	T-MP5611
6	68	Door or Rear Body Panel Emblem - "Road Runner"	Road Runner	999-1468-51
6	67-69	Deck Lid Emblem - "HEMI"	Plymouth B-Body	K-2840867
7	67&70	Quarter Panel Emblem - "SE Special Edition" - LH or RH	Coronet/Charger	K-2782966
8	69	Rear Body Panel Emblem - "R/T"	Charger	K-2902389
8	70	Rear Body Panel Emblem - "R/T"	Charger	K-2965253
8	70	Rear Body Panel Emblem - "R/T"	Coronet	K-3444609
9	70	Rear Body Panel Emblem - "500"	Coronet/Charger	K-3505338
10	68	Rear Body Panel Emblem - Arrow	Charger	K-2840065
11	71	Trunk Emblem "Charger DODGE DIVISION"	Charger	K-3570035
12	72-74	Trunk Lid Emblem - "GTX"	GTX	K-3680160
13	68	Trunk Trim Finish Panel - "PLYMOUTH" Letters	Satellite	K-MN2176
14	68	Trunk Trim Finish Panel - "PLYMOUTH" Letters	Road Runner	K-MN1462
15	67	Trunk Lid & Rear Seat Emblem - "GTX" - Pin-on Style	GTX	K-2840214
16	70	Taillight Panel Emblem - "Plymouth"	Plymouth B-Body	999-1470-91
17	69-70	Taillight Panel Emblem - (Non R/T)	Charger	999-2670-91
18	68	Rear Body Panel Emblem "Charger"	Charger	K-2840066
19	68	Trunk Trim Panel	GTX/Sport Satellite	K-MN1607
20	69	Trunk Trim Panel	GTX	K-MN1463
20	69	Trunk Trim Panel	Sport Satellite	K-2902910
21	68	Rear Finish Panel Hardware Kit	Satellite/GTX	A-270286



VISIT US ONLINE FOR THE MOST UP-TO-DATE PRICING AND SELECTION





GLASS



#	YEAR	DESCRIPTION	MODEL	PART #
1	62-63	Windshield - Clear	All B-Body	380-1462-C
2	62-63	Windshield - Green Tint	All B-Body	380-1462-T
	64-65	Windshield - Clear	All B-Body	380-1464-C
	64-65	Windshield - Green Tint	All B-Body	380-1464-T
	66-67	Windshield - Clear - 2DR Hardtop	All B-Body	380-1466-C
	67-67	Windshield - Green Tint - 2DR Hardtop	All B-Body	380-1466-T
	66-70	Windshield - Clear - Convertible	All B-Body	380-1466-C
	66-70	Windshield - Green Tint - Convertible	All B-Body	380-1466-T
	68-70	Windshield - Clear - 2DR Hardtop Sedan	All B-Body	380-1468-C
	68-70	Windshield - Green Tint - 2DR Hardtop Sedan	All B-Body	380-1468-T
	71-74	Windshield - Clear	All B-Body	380-1471-C
	71-74	Windshield - Green Tint	All B-Body	380-1471-T
3	68-70	Windshield Molding Set	All B-Body	385-1468-S
4	66-67	Windshield Gasket - w/ Trim Groove - 2DR Hardtop	All B-Body	G-WCRD671B
	66-70	Windshield Gasket - w/ Trim Groove - Convertible	All B-Body	G-WCRD671
	68-70	Windshield Gasket - w/ Trim Groove	All B-Body	G-WCRD715
5	66-67	Windshield Washer Hose Kit	All B-Body	F-WWK1
	68-70	Windshield Washer Hose Kit	All B-Body	F-WWK2
	71-72	Windshield Washer Hose Kit	All B-Body	F-WWK3
6	71-74	Washer Hose T Connector - Black	All B-Body	F-077B
7	66-67	Windshield Washer Nozzle	All B-Body	F-213
	71-72	Windshield Washer Nozzle	All B-Body	F-WWE
8	68-70	Windshield Washer Retainer	All B-Body	F-WMF
9	66-70	Wiper Pivot Seal Kit	All B-Body	F-WTE
10	71-74	Windshield Molding Clip Set - 20pcs	All B-Body	H-C-8006
11	66-67	Windshield Reveal Molding Clip Set - 48pcs	All B-Body	X385-1466-1S
	68-70	Windshield Reveal Molding Clip Set - 48pcs	All B-Body	X385-1468-1S
	71-74	Windshield Reveal Molding Clip Set - 40pcs	All B-Body	X385-1471-1S



VISIT US ONLINE
FOR THE MOST
UP-TO-DATE PRICING
AND SELECTION



GLASS

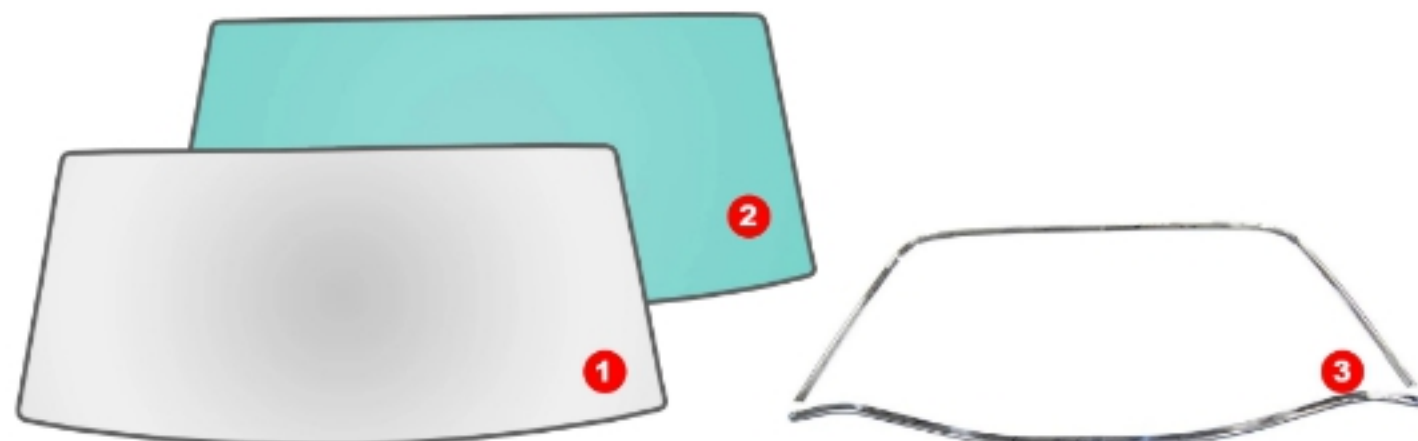

#	YEAR	DESCRIPTION	MODEL	PART #
1	66-67	Back Glass - Clear - (except Charger)	All B-Body	660-1466-C
2	66-67	Back Glass - Green Tint - (except Charger)	All B-Body	660-1466-T
	68-70	Back Glass - Clear - (except Charger)	All B-Body	660-1468-C
	68-70	Back Glass - Green Tint - (except Charger)	All B-Body	660-1468-T
	68-70	Back Glass - Clear	Charger	660-2668-C
	68-70	Back Glass - Green Tint	Charger	660-2668-T
	71-74	Back Glass - Clear	All B-Body	660-1471-C
	71-74	Back Glass - Green Tint	All B-Body	660-1471-T
3	68-70	Back Glass Molding Set - (except Charger)	All B-Body	670-1468-S
	68-70	Back Glass Molding Set	Charger	670-2668-S
4	68-70	Interior Rear Window Trim Set - 3pcs	All B-Body	A-181109
	68-70	Interior Rear Window Trim Set - 4pcs	Plymouth B-Body	A-181108
	68-70	Interior Rear Window Trim Set - 6pcs	Charger	A-181111
	68-70	Interior Rear Window Trim - Lower Corners - Pair	Charger	A-181113
	68-70	Interior Rear Window Trim - Lower Center	Charger	A-181114
	69	Interior Rear Window Trim Set - 6pcs	Charger 500/Daytona	A-181107
5	66-67	Rear Window Gasket - ZDR Hardtop (except Charger)	All B-Body	X661-1466
6	66-67	Rear Window Reveal Molding Clip Set - 40pcs - ZDR Hardtop	All B-Body	X671-1466-S
	68-70	Back Glass Molding Clip Set - (except Charger)	All B-Body	X671-1468-S
	71-74	Back Glass Molding Clip Set - 20pcs - ZDR Hardtop	All B-Body	X671-1471-S
7	68-70	Back Glass Molding Clip & Screw Set - 40pcs	Charger	X671-2668-S



VISIT US ONLINE
FOR THE MOST
UP-TO-DATE PRICING
AND SELECTION



WARNING: Cancer and Reproductive
Harm - www.P65Warnings.ca.gov



**AUTHENTIC
RESTORATION**

WWW.AUTOMETALDIRECT.COM

866.719.9505

44

GLASS



#	YEAR	DESCRIPTION	MODEL	PART #
1	66-67	Vent Glass - Clear - LH	All B-Body	560-1466-CL
	66-67	Vent Glass - Clear - RH	All B-Body	560-1466-CR
2	66-67	Vent Glass - Green Tint - LH	All B-Body	560-1466-TL
	66-67	Vent Glass - Green Tint - RH	All B-Body	560-1466-TR
68-70	Vent Glass - Clear - LH - (except Convertible)	All B-Body	560-1468-CL	
	Vent Glass - Clear - RH - (except Convertible)	All B-Body	560-1468-CR	
	Vent Glass - Green Tint - LH - (except Convertible)	All B-Body	560-1468-TL	
	Vent Glass - Green Tint - RH - (except Convertible)	All B-Body	560-1468-TR	
3	62-65	Vent Window Support Bracket - LH	All B-Body	562-1462-L
	62-65	Vent Window Support Bracket - RH	All B-Body	562-1462-R
4	66-70	Vent Window Regulator Access Hole Plug - Black	All B-Body	A-180099-100
	66-70	Vent Window Regulator Access Hole Plug - White	All B-Body	A-180099-200
	66-70	Vent Window Regulator Access Hole Plug - Dark Blue	All B-Body	A-180099-330
	66-70	Vent Window Regulator Access Hole Plug - Light Blue	All B-Body	A-180099-332
	66-70	Vent Window Regulator Access Hole Plug - Dark Green	All B-Body	A-180099-434
	66-70	Vent Window Regulator Access Hole Plug - Burnt Orange	All B-Body	A-180099-540
	66-70	Vent Window Regulator Access Hole Plug - Red	All B-Body	A-180099-550
	66-70	Vent Window Regulator Access Hole Plug - Gold	All B-Body	A-180099-630
5	66-70	Vent Window Regulator Access Hole Plug - Ember Gold	All B-Body	A-180099-637
	68-70	Vent Window Weatherstrips - Pair - 2dr Hardtop Sedan	All B-Body	X563-1468-2P



#	YEAR	DESCRIPTION	MODEL	PART #	
1	67	Door Glass - Clear - LH	All B-Body	550-1467-CL	
	67	Door Glass - Clear - RH	All B-Body	550-1467-CR	
2	67	Door Glass - Green Tint - LH	All B-Body	550-1467-TL	
	67	Door Glass - Green Tint - RH	All B-Body	550-1467-TR	
68-70	Door Glass - Clear - LH - 2DR Hardtop	All B-Body	550-1468-CL		
	Door Glass - Clear - RH - 2DR Hardtop	All B-Body	550-1468-CR		
	3	68-70	Door Glass - Clear - LH - 2DR Sedan	All B-Body	550-1468-CSL
	68-70	Door Glass - Clear - RH - 2DR Sedan	All B-Body	550-1468-CR	
68-70	Door Glass - Green Tint - LH - 2DR Hardtop	All B-Body	550-1468-TL		
	Door Glass - Green Tint - RH - 2DR Hardtop	All B-Body	550-1468-TR		
	4	68-70	Door Glass - Green Tint - LH - 2DR Sedan	All B-Body	550-1468-TSL
	68-70	Door Glass - Green Tint - RH - 2DR Sedan	All B-Body	550-1468-TSR	
5	71-74	Door Glass - Clear - LH - 2DR Hardtop	All B-Body	550-1471-CL	
	71-74	Door Glass - Clear - RH - 2DR Hardtop	All B-Body	550-1471-CR	
6	71-74	Door Glass - Green Tint - LH - 2DR Hardtop	All B-Body	550-1471-TL	
	71-74	Door Glass - Green Tint - RH - 2DR Hardtop	All B-Body	550-1471-TR	
7	68-74	Window Regulator Arm Clip	All B-Body	A-270006	



VISIT US ONLINE

 FOR THE MOST

 UP-TO-DATE PRICING

 AND SELECTION



Part Numbers Highlighted **BLUE** are Officially Licensed Mopar Authentic Restoration Products

GLASS

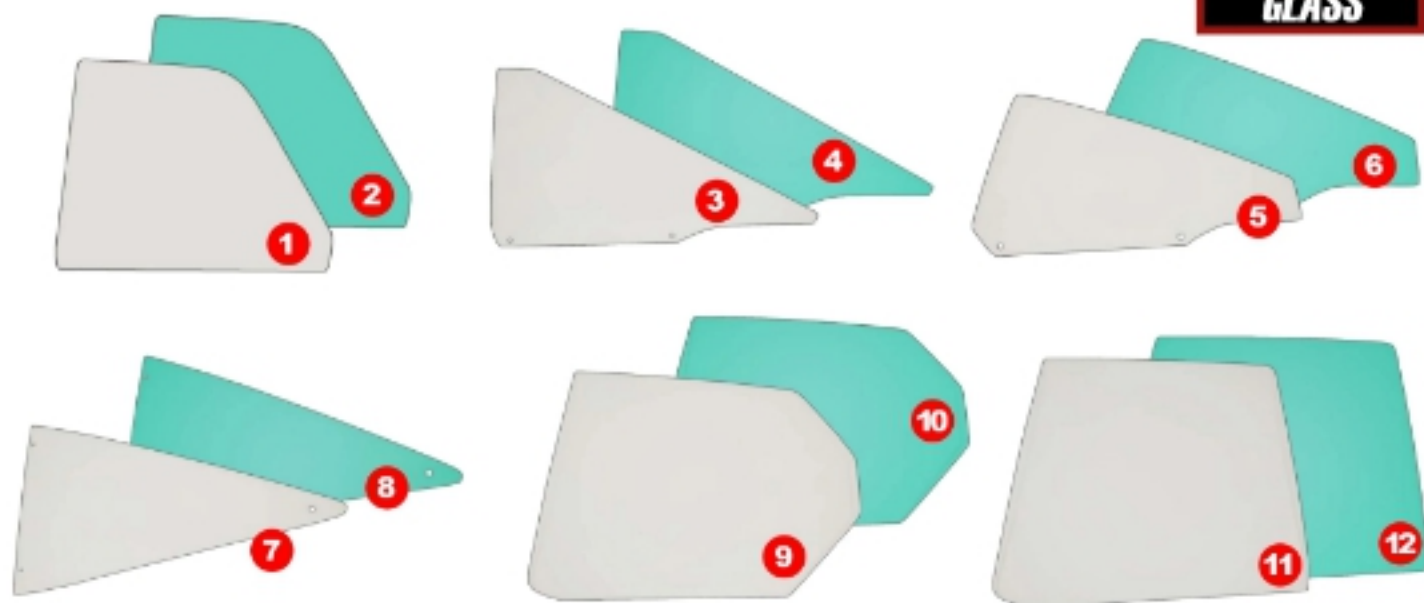

#	YEAR	DESCRIPTION	MODEL	PART #
1	63-65	Quarter Glass - Clear - LH or RH - 2DR Sedan	All B-Body	795-1463-CS
2	63-65	Quarter Glass - Green Tint - LH or RH - 2DR Hardtop	All B-Body	795-1463-T
3	67	Quarter Glass - Clear - LH - (except Charger)	All B-Body	795-1467-CL
4	67	Quarter Glass - Clear - RH - (except Charger)	All B-Body	795-1467-CR
5	67	Quarter Glass - Green Tint - LH - 2DR Hardtop (except Charger)	All B-Body	795-1467-TL
6	67	Quarter Glass - Green Tint - RH - 2DR Hardtop (except Charger)	All B-Body	795-1467-TR
7	68-70	Quarter Glass - Clear - LH - 2DR Hardtop	All B-Body	795-1468-CL
8	68-70	Quarter Glass - Clear - RH - 2DR Hardtop	All B-Body	795-1468-CR
9	68-70	Quarter Glass - Clear - LH - 2DR Sedan	Plymouth B-Body	795-1468-CSL
10	68-70	Quarter Glass - Clear - RH - 2DR Sedan	Plymouth B-Body	795-1468-CSR
11	68-70	Quarter Glass - Green Tint - LH - 2DR Hardtop	All B-Body	795-1468-TL
12	68-70	Quarter Glass - Green Tint - RH - 2DR Hardtop	All B-Body	795-1468-TR
13	68-70	Quarter Glass - Green Tint - LH - 2DR Sedan	Plymouth B-Body	795-1468-TSL
14	68-70	Quarter Glass - Green Tint - RH - 2DR Sedan	Plymouth B-Body	795-1468-TSR
15	68-70	Quarter Glass - Clear - LH - 2DR Sedan	Dodge B-Body	795-2468-CSL
16	68-70	Quarter Glass - Clear - RH - 2DR Sedan	Dodge B-Body	795-2468-CSR
17	68-70	Quarter Glass - Green Tint - LH - 2DR Sedan	Dodge B-Body	795-2468-TSL
18	68-70	Quarter Glass - Green Tint - RH - 2DR Sedan	Dodge B-Body	795-2468-TSR
19	71	Quarter Glass - Clear - LH - 2DR Hardtop	Plymouth B-Body	795-1471-CL
20	71	Quarter Glass - Clear - RH - 2DR Hardtop	Plymouth B-Body	795-1471-CR
21	71	Quarter Glass - Green Tint - LH - 2DR Hardtop	Plymouth B-Body	795-1471-TL
22	71	Quarter Glass - Green Tint - RH - 2DR Hardtop	Plymouth B-Body	795-1471-TR
23	71	Quarter Glass - Clear - LH	Charger	795-2671-CL
24	71	Quarter Glass - Clear - RH	Charger	795-2671-CR
25	71	Quarter Glass - Green Tint - LH	Charger	795-2671-TL
26	71	Quarter Glass - Green Tint - RH	Charger	795-2671-TR
27	68-70	Quarter Glass Latches - Pair - 2DR Sedan	All B-Body	796-1468-P
28	66-67	Quarter Window Roller Kit - 8pcs	All B-Body	A-280073
29	66-70	Quarter Window Roller Kit - 30pcs	All B-Body	X798-1466-35
30	66-67	Quarter Window Roller	All B-Body	A-280097
31	66-70	Quarter Window Roller	All B-Body	A-280079
32	67-70	Quarter Window Roller	All B-Body	A-280080
33	66-70	Quarter Window Roller	All B-Body	A-280081
34	67-70	Quarter Window Roller w/ Pin	All B-Body	A-280082
35	68-70	Quarter Window Seals - Pair - 2DR Sedan	Plymouth B-Body	X794-1468-1P
36	68-70	Quarter Window Seals - Pair - 2DR Sedan	Dodge B-Body	X794-2468-1P
37	71-74	Quarter Window Seals - Pair - 2DR Hardtop	Charger/Satellite	J-CH2108



VISIT US ONLINE FOR THE MOST UP-TO-DATE PRICING AND SELECTION



WARNING: Cancer and Reproductive Harm - www.P65Warnings.ca.gov



AUTHENTIC RESTORATION

WWW.AUTOMETALDIRECT.COM

866.719.9505

46

LIGHTING

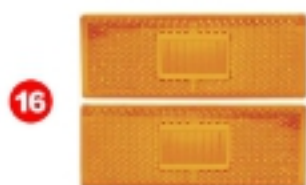

VISIT US ONLINE

 FOR THE MOST

 UP-TO-DATE PRICING

 AND SELECTION



#	YEAR	DESCRIPTION	MODEL	PART #
1	70	Front Side Marker Lamp Assembly - LH	Plymouth B-Body	X240-1470-L
	70	Front Side Marker Lamp Assembly - RH	Plymouth B-Body	X240-1470-R
	71	Front Side Marker Lamp Assembly - LH or RH	Charger	X251-2671
2	72-74	Front Side Marker Lamp Lens - Amber - LH or RH	All B-Body	K-3587436
3	70-72	Fender Mounted Turn Signal Gaskets - Pair	All B-Body	A-151003
	68-69	Turn Signal Indicator Assembly - Hood Mounted	Charger	X245-2668-S
4	67-69	Bullet Fender Turn Signal Lenses - Pair	Plymouth B-Body	A-200100
5	68-69	Park Lamp Assemblies - Pair	Coronet	K-MB5984
6	70	Park Lamp Assemblies - Pair	Plymouth B-Body	K-MB5986
7	68-69	Park Lamp Lenses - Pair	Plymouth B-Body	F-151-2
8	68-69	Park Lamp Lenses - Pair	Coronet	K-MB2121
9	68-69	Park Lamp Lenses - Pair - (except Daytona)	Charger	F-150-1
10	70	Park Lamp Lenses - Pair	Plymouth B-Body	K-MB2124
11	70	Park Lamp Lenses - Pair	Charger	F-552-3
	71-74	Park Lamp Lenses - Pair	Charger	A-200104
12	66	Park Lamp Lens - Clear - LH or RH	Belvedere/Satellite	T-MP4100
	71-74	Park Lamp Lens - Clear - LH	Charger	X135-2671-L
	71-74	Park Lamp Lens - Clear - RH	Charger	X135-2671-R
13	72-74	Rear Side Marker Lamp Lens - Red	All B-Body	K-3587440
14	68	Side Marker Lamp Assembly - Front (Flat) - Amber - LH or RH - (except Charger)	All B-Body	T-MP4150
	68	Side Marker Lamp Assembly - Rear (Flat) - Red - LH or RH	Plymouth B-Body	T-MP4160
	68	Side Marker Lamp - Front - Curved Style - LH or RH	Charger	K-MD2054A
	68	Side Marker Lamp - Rear - Curved Style - LH or RH - (except Wagon)	Coronet/Charger	K-MD2055A
	70	Side Marker Lamp Assembly - Rear - RH - (except Wagon)	Plymouth B-Body	K-MB1792
	70	Side Marker Lamp Assembly - Rear - LH - (except Wagon)	Plymouth B-Body	K-MB1793
	71	Side Marker Lamp Assembly - Rear - LH or RH	Charger	K-MB1795
15	69	Side Marker Lens Set - 4pcs	All B-Body	S-B5M2R
	70	Side Marker Lens Set - 4pcs - (except Wagon)	Plymouth B-Body	S-200103
16	70	Side Marker Lamp Lenses - Front - Pair	Plymouth B-Body	K-MD2058
	70	Side Marker Lamp Lenses - Red - Rear - Pair - (except Wagon)	Plymouth B-Body	K-MD2059
17	69	Side Marker Lamp Bezels - Front or Rear - Pair - (except Wagon)	All B-Body	K-MD2060

LIGHTING



1



2



3



4



5



6

#	YEAR	DESCRIPTION	MODEL	PART #
1	70	Tail Lamp Lenses	Charger	X951-2670
	71	Tail Lamp Lenses without Black Trim - Pair	Road Runner/Satellite	K-MB2139
2	71	Tail Lamp Lens - w/ Black Trim - LH or RH	GTX/Sport Satellite	X951-1471-1
3	73-74	Tail Lamp Lens - w/o Silver Trim - LH	Charger	X951-2673-1L
	73-74	Tail Lamp Lens - w/o Silver Trim - RH	Charger	X951-2673-1R
	73-74	Tail Lamp Lens - w/ Silver Trim - LH	Charger	X951-2673-L
	73-74	Tail Lamp Lens - w/ Silver Trim - RH	Charger	X951-2673-R
4	71	Tail Lamp & Backup Lens Set - 6pcs - (except R/T 500)	Charger	K-MB3580
5	69-70	Back-up Lamp Assemblies - Pair	Road Runner/Charger	X955-1469-P
	70	Back-up Lamp Assemblies - Pair	Plymouth B-Body	K-MB5985
6	66-67	Back-up Lamp Lens - LH or RH	Coronet/Charger	T-MP4125
	70	Back-up Lamp Lenses - Pair	Plymouth B-Body	K-MB274

PAINT GASKET SET

Complete factory-style replacement exterior gasket set which replaces all of the exterior gaskets as is typical during the course of repainting a vehicle. This gasket set includes all gaskets that touch the paint (as applicable), such as side marker to body gaskets, tail lamp to body gaskets, door handle gaskets, exterior rear view mirror gaskets, etc.



1

#	YEAR	DESCRIPTION	MODEL	PART #
1	66-67	Paint Gasket Set	Charger	A-151027
	68	Paint Gasket Set	Coronet	A-151009
	68	Paint Gasket Set	Plymouth B-Body	A-151010
	69	Paint Gasket Set	Coronet	A-151012
	69	Paint Gasket Set	Charger	A-151011
	70	Paint Gasket Set	Coronet	A-151015
	70	Paint Gasket Set	Road Runner/GTX	A-151016
	70	Paint Gasket Set	Satellite	A-151033
	71	Paint Gasket Set	Charger (Non R/T)	A-151042
	71	Paint Gasket Set	Charger R/T 500	A-151043
	72	Paint Gasket Set	Charger (non Rallye)	A-151044
	72	Paint Gasket Set	Charger Rallye	A-151045



VISIT US ONLINE
FOR THE MOST
UP-TO-DATE PRICING
AND SELECTION



WARNING: Cancer and Reproductive
Harm - www.P65Warnings.ca.gov



**AUTHENTIC
RESTORATION**

WWW.AUTOMETALDIRECT.COM

866.719.9505

48



GAS TANK

AMD OE replacement fuel tanks are stamped from high quality rust resistant steel which is lead/lin plated inside and out. Each tank features the correct shape, size, holes, ribs and corrugate, like original. All tanks are pressure tested for leaks. Mounting straps and sending units are sold separate.



1



2



3



4



5

6



#	YEAR	DESCRIPTION	MODEL	PART #
1	66-67	Gas Tank - 19 Gallon	All B-Body	890-1466
2	68-70	Gas Tank - 19 Gallon - w/o EEC	Charger	890-2668
	68-70	Gas Tank - 19 Gallon - w/ 2 Front Vent Lines - (except Charger)	All B-Body	890-1468-2
	70	Gas Tank - 19 Gallon - w/ 4 Front Vent Lines - (except Charger)	All B-Body	890-1470-4
	70	Gas Tank - 19 Gallon - w/ 4 Side Vent Lines	Charger	890-2670
	71-72	Gas Tank - 20 Gallon - w/ 4 Side Vent Lines	All B-Body	890-1471
	72-73	Gas Tank - 20 Gallon - w/ 4 Front Vent Lines	All B-Body	890-1472
	74	Gas Tank - 20 Gallon	All B-Body	890-1474
3	66-67	Gas Tank Strap - Each - One Used Per Car	All B-Body	X880-1466
4	68-70	Gas Tank Straps - Pair	All B-Body	X880-1468-P
	71-73	Gas Tank Straps - Pair	All B-Body	X880-1471-P
5	68-74	Gas Tank Strap Hardware Kit - 4 pcs	All B-Body	X880-1000-1S
6	62-79	Gas Tank Anti-Squeak 5-Piece Kit	All B-Body	W-862A



VISIT US ONLINE
FOR THE MOST
UP-TO-DATE PRICING
AND SELECTION



GAS TANK



1



2



3



4



5



6



9



10



7



8



11



12



13



14

#	YEAR	DESCRIPTION	MODEL	PART #
1	66-67	Filter Tube Kit - 3pcs	All B-Body	F-TEA
	66-67	Filter Tube Kit - 4pcs	All B-Body	F-TEAG
2	66-67	Filter Tube Elbow w/ Clamps	All B-Body	F-859A
3	66-67	Vent Line Elbow w/ Clamps	All B-Body	F-860A
4	68-70	Filler Tube to Trunk Floor Seal	Charger	F-539
5	66-67	Gas Tank Pad	All B-Body	F-TIP1
	68-70	Gas Tank Pad	All B-Body	F-TIP2
	71-74	Gas Tank Pad	All B-Body	F-TIP3
6	66-67	Gas Tank Sending Unit - 3/8 Outlet - w/o Return Line	All B-Body	881-1466-3
	66-67	Gas Tank Sending Unit - 5/16 Outlet - w/o Return Line	All B-Body	881-1466-5
	68-70	Gas Tank Sending Unit - 3/8 Outlet - w/ Return Line	All B-Body	881-1468-3R
	68-70	Gas Tank Sending Unit - 5/16 Outlet - w/o Return Line	All B-Body	881-1468-5
	71-73	Gas Tank Sending Unit - 3/8 Outlet - w/ Return Line	All B-Body	881-1471-3R
	71-73	Gas Tank Sending Unit - 5/16 Outlet - w/o Return Line	All B-Body	881-1471-5
7	65-74	Gas Tank Sending Unit Float Brass	All B-Body	A-240075
8	65-74	Gas Tank Sending Unit Sock Filter - 5/16	All B-Body	A-240076
	66-71	Gas Tank Sending Unit Sock Filter - 3/8	All B-Body	A-240077
9	65-74	Gas Tank Sending Unit Ground Strap	All B-Body	K-MF290
10	68-70	Filler Neck w/ Cap - (except Charger)	All B-Body	891-1468
11	68-69, 71-74	Filler Neck Grommet - 2" Diameter - w/ Single Lip	All B-Body	891-1068-1
	70	Filler Neck Grommet - 2" Diameter - w/ Double Lip	All B-Body	891-1570-1
12	68-70	Gas Cap - (except Charger)	All B-Body	X888-1468-1
13	67-68	Flip-up Gas Cap	GTX/Charger	F-339A
	69-70	Flip-up Gas Cap	Charger	F-878
	69-70	Flip-up Gas Cap	Charger	K-MF362
14	68-70	Flip-up Gas Cap Trim Ring	Charger	K-MF364



VISIT US ONLINE FOR THE MOST UP-TO-DATE PRICING AND SELECTION



WARNING: Cancer and Reproductive Harm - www.P65Warnings.ca.gov



AUTHENTIC RESTORATION

WWW.AUTOMETALDIRECT.COM

866.719.9505

50



B-BODY

Part Numbers Highlighted **BLUE** are Officially Licensed Mopar Authentic Restoration Products

HARDWARE

MASTER CHASSIS KIT INCLUDES:

DESCRIPTION	PIECES	DESCRIPTION	PIECES
Differential Carrier Cover - 9 3/4 - 3/8" HK Flg Bolts "E"	10	Brake Drum Retainers - 1/2" Stud, Green Push on Retain	6
Engine Insulator > Eng Belts - exc HEMI - RR Nuts, Coni WA's	4	Steering Linkage - Tri-Slot Nuts, Center Pins	12
Engine Mount Brackets - 383/440 - HK Bolts, 5/8 AF Nuts, Flat WA's	19	Wheel Cylinders (2) w 5/16-18 - 5/16-18 RR Ext Sems	4
Engine Insulator > Body - WB exc HEMI - RR Bolts "3B", Coni WA's	4	Brake Cable Tension Adjuster - Flange Lock Nut Only	1
Trans Insulator > Crossmember - Lock Nut	1	Proportioning Valve > Apron - Red Flange Lock Nut	1
Wheel Cylinders (2) w 1/4-20 - Hs Flgn Screws	4	Stabilizer Bar Center Supports - RR Coni Sems, HK Nuts	8
Strut Rod > K-Frns (B & E Body) - 5/8-11 Lock Nuts	4	Control Arms (UPR) - Cam Bolts, Washers, Nuts	16
Driveshaft > Flange - Straps, HK Bolts, Split WA's	10	Leaf Spring Mounting @ Front - "H" Marked Bolts, Mandrel Nut	4
Shocks (Fr) - Lwr Mounting - HK Bolts "TR" or "D", Lock Nuts	4	Idler Arm - "TR" Hex Bolt, Tri-Slot Nut, Pin	3
Leaf Spring Mounting @ Front - Hub Bolts, Coni Raps	16	K-Frame > Body - Special Hex Coni Sems	4
Shackles - Nuts Only - RR Nuts	4	Trans Crossmember - RR Bolts, Flat WA's, Coni Raps	12
Axle Bearings > Springs - 1/2-20 x 7.12 U-Bolts, Lock Nuts	12	Trans Insulator > Trans - RR Coni Sems	2
Suspension Bumper Bkts > B 3/4 Axle - Hs Coni Sems "Anchor"	2	Axle Retaining Nuts - HK Lock Nuts, Flg Nuts	10
Suspension Bumpers (R) - Hs Coni Sems "Anchor"	4	Ball Joints w/ Disc Brakes - HK Bolts, Matched Nuts, Pins	12
Shocks (R) - Upr Mounting - Hs Bolts, Lock Nuts	4	Brake Calipers > Spindle - HK Bolts	4
Shocks (R) - Lwr Mounting - Hs Nuts Only	2	Pitman Arm - Nut, Split WA	2
Brake Rotar Shields - Hs Coni Sems	6	Brake Hoses > Bracket Clips - U-Clips	3
Steering Gear (to body) - Hs-Hs HD Bolts, Split WA's	6	Parking Brake Control > Body - EXT Raps	3
Brake Caliper Tube Brackets - RR Coni Sems	4	Master Cylinder - Ext Raps	4
Gas Tank - J-Bolts, Lock Nuts	4	Master Cylinder Support Plate - Coni Raps, EXT Raps, Sealer	4
Differential Carrier - B 3/4 - Nuts w/ Nylon Pellet	10	Brake Booster - EXT Raps	4
Suspension Bumper Bkts > 9 3/4 Axle - Hs Coni Sems "Anchor"	3	Accelerator Pedal (B & E body) - Coni Raps, Coni Sems	6
Suspension Bumpers (Fr) - Hug-Lok Nuts	4		



1



2

Kit includes:

- Upper Fender to lower fender slip-on nuts and dog point bolts with built in washer
- Front core support to fender slip on nuts and dog point bolts with built in washer
- Lower fender to rocker deep slip-on nuts, stud and washer with capered nut
- Head to Hood Hinge bolts
- Head Hinge to lower fender bolts
- Door Hinge to Door bolts (upper and lower)
- Door Hinge to A Pillar body bolts (upper and lower)
- Deck lid to Deck lid Hinge bolts

#	YEAR	DESCRIPTION	MODEL	PART #
1	66-67	Master Chassis Hardware Kit - 256pcs - 383/440 w/ Disc Brakes	All B-Body	H-66B-BBDC
	66-67	Master Chassis Hardware Kit - 262pcs - 383/440 w/ Drum Brakes	All B-Body	H-66B-BBDR
	66-67	Master Chassis Hardware Kit - 253pcs - HEMI w/ Disc Brakes	All B-Body	H-66B-HEDC
	66-67	Master Chassis Hardware Kit - 259pcs - HEMI w/ Drum Brakes	All B-Body	H-66B-HEDR
	66-67	Master Chassis Hardware Kit - 252pcs - 273/318 w/ Disc Brakes	All B-Body	H-66B-SBDC
	66-67	Master Chassis Hardware Kit - 258pcs - 273/318 w/ Drum Brakes	All B-Body	H-66B-SBDR
	68-69	Master Chassis Hardware Kit - 260pcs - 383/440 w/ Disc Brakes	All B-Body	H-68B-BBDC
	68-69	Master Chassis Hardware Kit - 266pcs - 383/440 w/ Drum Brakes	All B-Body	H-68B-BBDR
	68-69	Master Chassis Hardware Kit - 257pcs - HEMI w/ Disc Brakes	All B-Body	H-68B-HEDC
	68-69	Master Chassis Hardware Kit - 263pcs - HEMI w/ Drum Brakes	All B-Body	H-68B-HEDR
	68-69	Master Chassis Hardware Kit - 256pcs - 273/318 w/ Disc Brakes	All B-Body	H-68B-SBDC
	68-69	Master Chassis Hardware Kit - 262pcs - 273/318 w/ Drum Brakes	All B-Body	H-68B-SBDR
	70	Master Chassis Hardware Kit - 266pcs - 383/440 w/ Disc Brakes	All B-Body	H-70B-BBDC
	70	Master Chassis Hardware Kit - 268pcs - 383/440 w/ Drum Brakes	All B-Body	H-70B-BBDR
	70	Master Chassis Hardware Kit - 262pcs - HEMI w/ Disc Brakes	All B-Body	H-70B-HEDC
	70	Master Chassis Hardware Kit - 264pcs - HEMI w/ Drum Brakes	All B-Body	H-70B-HEDR
	70	Master Chassis Hardware Kit - 262pcs - 318 w/ Disc Brakes	All B-Body	H-70B-SBDC
	70	Master Chassis Hardware Kit - 264pcs - 318/ w/ Drum Brake	All B-Body	H-70B-SBDR
	71-72	Master Chassis Hardware Kit - 259pcs - 383/400/440 w/ Disc Brakes	All B-Body	H-71B-BBDC
	71-72	Master Chassis Hardware Kit - 272pcs - 383/400/440 w/ Drum Brakes	All B-Body	H-71B-BBDR
	71	Master Chassis Hardware Kit - 266pcs - HEMI w/ Disc Brakes	All B-Body	H-71B-HEDC
	71	Master Chassis Hardware Kit - 268pcs - HEMI w/ Drum Brakes	All B-Body	H-71B-HEDR
	71-72	Master Chassis Hardware Kit - 256pcs - 318/340 w/ Disc Brakes	All B-Body	H-71B-SBDC
	71-72	Master Chassis Hardware Kit - 258pcs - 318/340 w/ Drum Brakes	All B-Body	H-71B-SBDR
	73-74	Master Chassis Hardware Kit - 266pcs - 383/400/440 w/ Disc Brakes	All B-Body	H-73B-BBDC
	73-74	Master Chassis Hardware Kit - 252pcs - 318/340/360 w/ Disc Brakes	All B-Body	H-73B-SBDC
2	66-70	Body Bolt Fastener Kit - (fenders, Hood, Doors, Deck Lid)	All B-Body	X225-1466-15



VISIT US ONLINE
FOR THE MOST
UP-TO-DATE PRICING
AND SELECTION



ENGINE



1



2



3



4



5



6

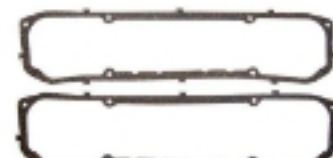

7



8



9



10



11



12



13



#	YEAR	DESCRIPTION	MODEL	PART #
1	68	Valve Covers - Pair	Big Block 383/440HP	335-1068-BPK
2	69	Valve Covers - Pair	Big Block 383/440HP/440+6	335-1069-BPK
3	70-71	Valve Covers - Pair	Small Block	335-1070-1PK
4	70	Valve Covers - Pair	Big Block 383/440HP/440+6	335-1070-BPK
5	71-72	Valve Covers - Pair	Big Block 383/440HP/440+6	335-1071-BPK
6	72	Valve Covers - Pair	Small Block	335-1072-1PK
7	64-74	Valve Cover Gaskets - Pair	Big Block	336-1064-S
	70-71	Valve Cover Gaskets - Pair	Small Block	336-1070-1S
8	64-67	Oil Filler Breather Cap - Small - Paintable		337-1064
	64-69	Oil Filler Breather Cap w/ PCV Mount - Paintable		337-1064-1
	64-69	Oil Filler Breather Cap w/ PCV Mount - Chrome		337-1064-1C
	64-67	Oil Filler Breather Cap - Small - Chrome		337-1064-C
	68-69	Oil Filler Breather Cap - Tall w/ 1 Hose Outlet - Paintable		337-1068
	68-69	Oil Filler Breather Cap - Tall w/ 1 Hose Outlet - Chrome		337-1068-C
	70-74	Oil Filler Breather Cap w/ 1 Hose Outlet		337-1070-1
	70-74	Oil Filler Breather Cap w/ 2 Hose Outlet		337-1070-2
	70-74	Oil Filler Breather Cap w/ 3 Hose Outlet		337-1070-3
9	70-72	Oil Filler Cap		337-1070
10	67-72	Valve Cover PCV Valve Grommet		336-1067-1
	70-72	Valve Cover Crankcase Breather Grommet		336-1070-1
11	66-70	Valve Cover Bolt Kit - HEMI Only		A-270742
	71	Valve Cover Bolt Kit - HEMI Only		A-270743
12	66-70	Valve Cover Fasteners - 40pcs - HEMI		H-C-8015
	64-74	Valve Cover Fasteners - 12pcs	Small Block	H-C-8032
	64-74	Valve Cover Fasteners - 16pcs	Big Block	H-C-8033
	71	Valve Cover Fasteners - 40pcs	Hemi	H-C-8035
13	67-74	Engine Mount Bracket Bolt Set	Small Block	H-C-8087
	67-74	Engine Mount Bracket Bolt Set	Big Block	H-C-8086



B-BODY

Part Numbers Highlighted **BLUE** are Officially Licensed Mopar Authentic Restoration Products



Show your Mopar pride with our high quality t-shirts. These are high quality Next Level shirts that runs small in size. They are super soft, comfortable, and an perfect every day use t-shirt!

Size = Small thru 5XL
60% Cotton, 40% Polyester

APPAREL

Our popular Mopar shirt design is also available in a Hoodie!
Featuring a awesome Cuda and a pro touring Charger. Show off your Mopar and support for your favorite Mopar restoration parts supplier - Auto Metal Direct!
** Pre-Shrunk fleece knit with a softer feel keeping you warm and cozy.*

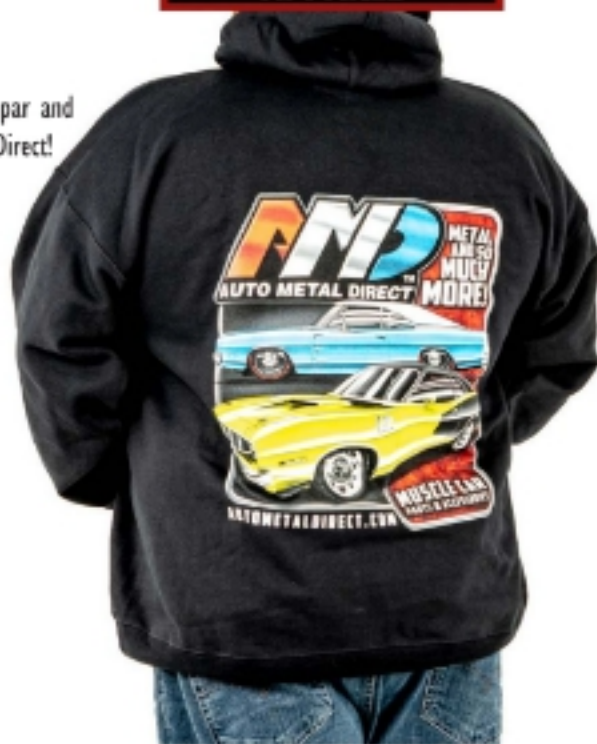

#	DESCRIPTION	PART #
	Mopar T-Shirt - Small - Black	AMD MOPAR-S
	Mopar T-Shirt - Medium - Navy	AMD MOPAR-M
	Mopar T-Shirt - Large - Navy	AMD MOPAR-L
	Mopar T-Shirt - X-Large - Navy	AMD MOPAR-XL
	Mopar T-Shirt - 2X-Large - Navy	AMD MOPAR-2XL
	Mopar T-Shirt - 3X-Large - Navy	AMD MOPAR-3XL
	Mopar T-Shirt - 4X-Large - Navy	AMD MOPAR-4XL
	Mopar T-Shirt - 5X-Large - Navy	AMD MOPAR-5XL
	Mopar Hoodie - Small - Black	AMD MOPAR-HOOD-S
	Mopar Hoodie - Medium - Black	AMD MOPAR-HOOD-M
	Mopar Hoodie - Large - Black	AMD MOPAR-HOOD-L
	Mopar Hoodie - X-Large - Black	AMD MOPAR-HOOD-XL
	Mopar Hoodie - 2X-Large - Black	AMD MOPAR-HOOD-2XL
	Mopar Hoodie - 3X-Large - Black	AMD MOPAR-HOOD-3XL
	Mopar Hoodie - 4X-Large - Black	AMD MOPAR-HOOD-4XL
	Mopar Hoodie - 5X-Large - Black	AMD MOPAR-HOOD-5XL



HATS



This Auto Metal Direct hat is the original Flexfit cap with poly-weave spandex to assure you get the perfect fit.



Classic AMD embroidered trucker cap built with the Richardson 112 quality and fit you've come to expect from premium headwear.

#	DESCRIPTION	PART #
1	AMD Black Flexfit Cap	AMDHAT-2
2	AMD Black Snapback Cap	AMDHAT-3

SHOP BANNER



Don't forget about our premium AMD vinyl logo sign banner. Made from 16oz vinyl, UV printing, and laminated, it's made to withstand the test of time. It comes complete with metal grommets at each corner for easy installation. *"Measures 4' X 3"*

#	DESCRIPTION	PART #
1	AMD Logo Banner 4' x 3' with grommets	AMDBANNER4X3



 VISIT US ONLINE
 FOR THE MOST
 UP-TO-DATE PRICING
 AND SELECTION



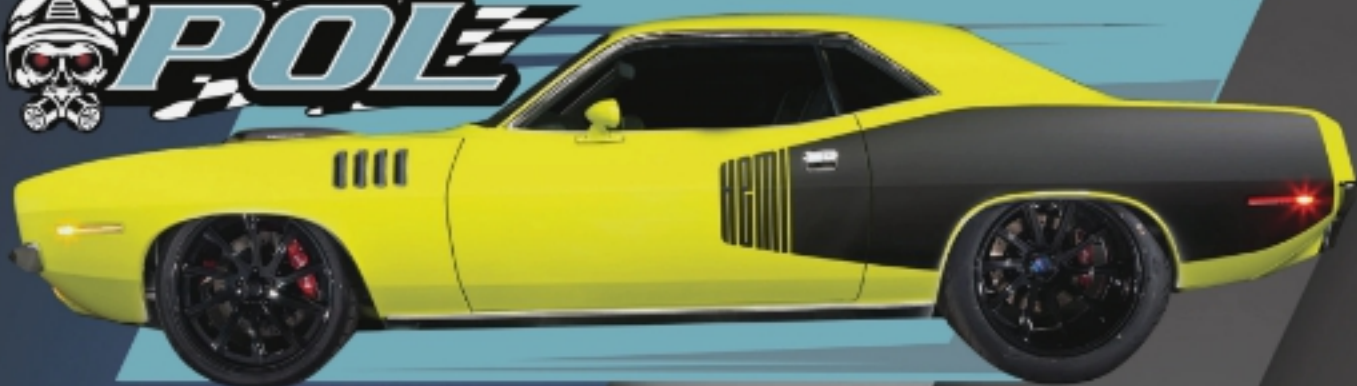

MASTER CYLINDERS



BLACKOUT

DISC BRAKES



FRONT END REBUILD KIT



TUBULAR CONTROL ARM KITS



DROP SPINDLES



ADJUSTING TIE ROD ENDS



MONO LEAF SPRINGS



STEERING



CAL TRAC TRACTION BARS



800.638.1703

1550 MELISSA CT. CORONA, CA 92879

performanceonline.com

Follow us:

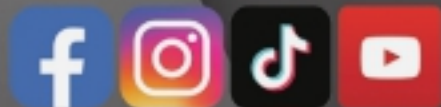



A, B&E, C BODY MOPAR



1965 & UP

Chrysler, Dodge & Plymouth

DISC BRAKE CONVERSIONS

1965 & UP

Chrysler, Dodge & Plymouth

BRAKE BOOSTERS & MASTER CYLINDERS

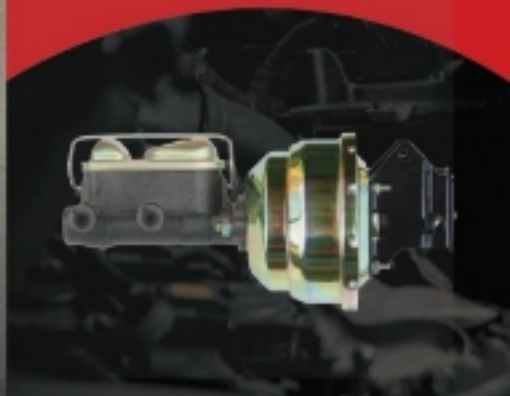

3248 UNION RD. CHEEKTOWAGA, NY 14227 | 716-852-2139 | LEEDBRAKES.COM | @LEEDBRAKES

FiTech
Fuel Injection



UNIVERSAL EFI SYSTEMS FOR YOUR CLASSIC



TRIPower SYSTEMS

THROTTLE BODY SYSTEMS

CLASSIC EFI SYSTEMS



- Easy, bolt-on systems
- Fully equipped kits
- Self-learning EFI
- Enhanced fuel efficiency
- Quick starts, every time

FOR MORE INFO VISIT: **FITECHEFI.COM**

OR CALL: **(951) 340-2624**



ORDERING INFORMATION

Internet Orders

Shop our complete product offering anytime online at autometaldirect.com. Here you will find our most up-to-date product offerings, pricing, inventory and information. Join our community of customer rides or browse through our selection of installation videos.

Phone Orders

Feel free to call us toll-free at 833.404.4443 from anywhere in the U.S. or Canada. Our sales staff has a wealth of knowledge and first-hand experience and can assist you with any questions you may have. Our call center hours are 8:00 a.m. - 6:00 p.m. Monday - Friday, Eastern Standard. Our call center is closed on Saturday and Sunday and some U.S. Federal Holidays.

Customer Pick Up Orders

AMD offers a customer pick-up option at no additional fee. We encourage this option whenever possible to save you money on shipping your order. You can pick up your order from our retail store located at 3348 Gateway Centre Parkway, Gainesville, GA 30507. We HIGHLY recommend placing your order prior to arriving at our location to save you time. Feel free to call us toll-free at 833.404.4443 from anywhere in the U.S. or Canada. Our retail showroom hours are 8:00 a.m. - 5:00 p.m. Monday - Friday, Eastern Standard Time. Our retail showroom is closed on Saturday and Sunday and some U.S. Federal Holidays.

International Orders

For orders outside the United States or Canada, please utilize our website for international orders or call us by dialing the international access code then 1.770.967.0909.

PAYMENT METHODS

Credit / Debit Cards

We gladly accept Visa, Mastercard, Discover or American Express credit cards and Visa and Mastercard Debit Cards. We must be able to verify the shipping address on your card before shipment.

PayPal

We will accept Paypal for online orders that are shipped via FedEx Ground inside the continental U.S.

Check / Money Order / Other

We accept payments via money order, personal check, business check or cashier's check. We reserve the right to hold orders until payment clears. We cannot ship any order via C.O.D.

SHIPPING

Ground Shipments

AMD utilizes FedEx Ground for small parcel shipments. We do offer Express Ground (1,2, or 3 day) for an additional fee. Please inform your salesperson or notate on your order if you would like to utilize a Express method. Delivery dates are expectations and are not guaranteed.

Oversize Box Shipments

Oversize package fees are assessed on a per piece basis depending on the shipping size of the product. Oversize fees are in addition to the flat rate ground shipping fee.

Truck Freight

Any item(s) too large to ship FedEx Ground will be shipped via truck freight. Please check autometaldirect.com for the most up-to-date shipping zones and freight charges under the Shipping & Returns tab at the top of the website.

Damages

ALL TRUCK FREIGHT SHIPMENTS MUST BE INSPECTED AT THE TIME OF DELIVERY! If you find any damages you must contact AMD as soon as possible. If your shipment contains damage, please note 'DAMAGED' with the freight carrier at time of delivery and call us immediately at 866.591.8309. AMD will work with you and the freight carrier to find the best solution.

Additional Boxing Fees

Due to the fragile nature of glass, we have gone the extra mile in packaging orders that contain individual glass pieces and glass kits. The following charges will be added to full glass kits, windshields and some back glass orders. These fees are to cover the cost of the protective packaging and will be added to the actual shipping fee:

Windshield / Back Glass	add \$35.00
Complete Glass Sets	add \$60.00

Some other items require more attention when packaging to ensure that you receive them in the best condition possible. These items will incur an additional boxing or crate fee. These fees are to cover the cost of the protective packaging and will be added to the actual shipping fee:

Bed Floor Crate	add \$200.00
Hood Safety Box	add \$45.00



GUARANTEE

Parts Guarantee

All Auto Metal Direct brand products are guaranteed to be free from defects in material and workmanship. We require that you test fit ALL parts before sanding, priming, painting or modifying them in any way. If we deem your part defective, our responsibility is to replace the part, issue credit, or refund the original purchase price. We are not responsible for any paint or labor expenses. The credit or refund amount will not exceed the defective part's original purchase price and may be subjected to being issued as in-store credit.

BACK ORDERS

Back Orders

Any items not available at the time the order is placed will be put on backorder. All backordered items that ship after the original shipment will be subject to additional shipping charges. Backorders will not be shipped without your prior authorization. Please let us know if you do not wish to receive backorders.

RETURNS

Returns

You may return any unused, undamaged, unmodified, and resellable part in its original packaging for exchange, credit or refund for up to 6 months after original purchase date. All orders, cancellations and returns are subject to a 15% restocking fee. **ALL RETURNS MUST HAVE PRIOR AUTHORIZATION BEFORE THEY WILL BE ACCEPTED.** All shipping costs associated with a return are your responsibility. If the return shipment is damaged in transit back to us, it may not be accepted.

MORE PARTS ONLINE

Additional Parts Available

Although this catalog is geared towards the Mopar owner, we do carry a LOT of parts for other makes and models. If you're anything like us, you have several projects that consist of a large variety of vehicles saved from the scrap heap. Be sure to check out our full selection at autometaldirect.com

COPYRIGHT / TRADEMARK

Copyright and Trademark Information

For this catalog, All rights are reserved. No part of this catalog is to be reproduced, copied, or retransmitted in any form or means without direct written consent from Auto Metal Direct. AMD Auto Metal Direct, 'Our Name Says it All' and 'Never Too Far Gone' are registered trademarks of Auto Metal Direct.

© Copyright 2024 Auto Metal Direct, LLC.

Any part indicated MOPAR Authentic Restoration Part are officially manufactured and licensed under the MOPAR Authentic Restoration License Program. Logos, illustrations, images and trademarks of Stellantis are used under license by AMD and our suppliers. Any descriptions bearing trade-marked names are for application reference only.



Any part indicated MOPAR Authentic Restoration Part are officially manufactured and licensed under the MOPAR Authentic Restoration License Program. Logos, illustrations, images and trademarks of Stellantis are used under license by AMD and our suppliers. Any descriptions bearing trade-marked names are for application reference only.



AMD Garage is our show series dedicated to bringing you the best of the best. We offer the latest content from industry leaders, top builders, DIY car enthusiast, car and truck shows, social media influencers, and so much more. Follow us at [@autometaldirect](https://www.instagram.com/autometaldirect) on all major social media outlets.

